



ALIS

PRO

GENERAL SURGERY

- Scissors
- Needle Holders and Cases
- Ligature Needles
- Forceps and Clamps
- Skin Hooks
- Retractors Universal Ring Retractor System
- Self Retaining Retractors
- Rectal Specula
- Instruments
- Probes, Dilators and Scoops
- Scalpel Blades and Handles
- Amputation and Autopsy Instruments
- Suction Instruments
- Rulers, Calipers and Accessories Metal
- Bowls and Cups

5



CATALOGUE

GENERAL SURGERY

Scissors

DEAVER SUTURE SCISSORS



Catalog Number	Tip	Blade	Length (in.)
BC374R	S/B	STR	5 3/4
BC474R	S/B	CVD	5 3/4
BC464R	B/B	CVD	5 3/4

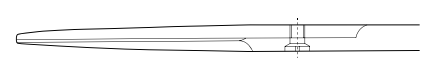
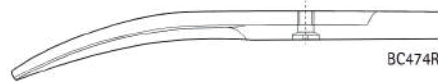
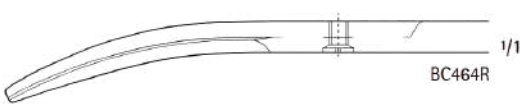

SUTURE SCISSORS



Catalog Number	Tip	Blade	Length (in.)
BC130R	S/S	STR	4 3/4
BC341R	S/S	STR	4 1/2
BC343R	S/S	STR	5 1/8
BC344R	S/S	STR	5 3/4
BC345R	S/S	STR	6
BC346R	S/S	STR	6 1/2
BC131R	S/S	CVD	4 3/4

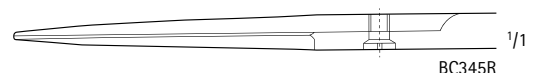
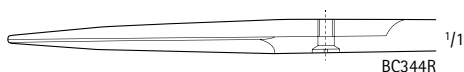
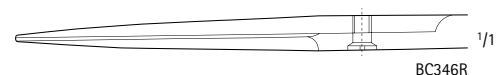
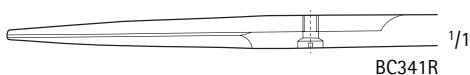
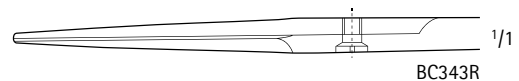
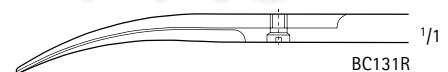
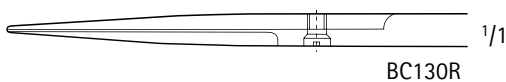

GENERAL SURGERY

Scissors

SUTURE SCISSORS



BC441R-BC445R

Catalog Number	Tip	Blade	Length (in.)
BC441R	S/S	CVD	4 1/2
BC443R	S/S	CVD	5 1/8
BC444R	S/S	CVD	5 3/4
BC445R	S/S	CVD	6

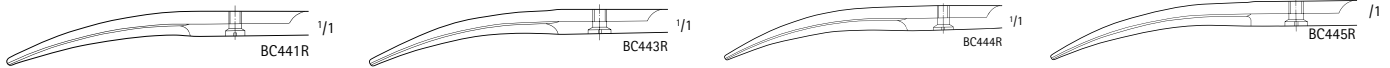

SUTURE SCISSORS



Catalog Number	Tip	Blade	Length (in.)
BC303R	S/B	DEL, STR	5 1/8
BC304R	S/B	DEL, STR	5 3/4

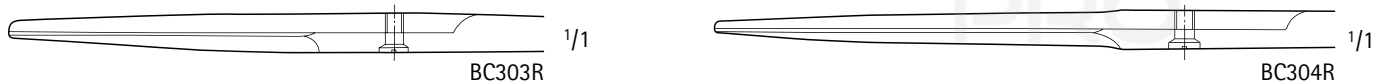

SUTURE SCISSORS



BC496R

Catalog Number	Tip	Blade	Length (in.)
BC496R	S/B	STR/1-SERR	5 1/8

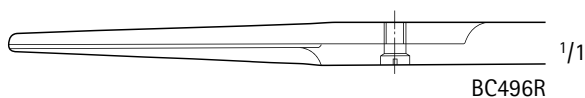

Scissors

SUTURE SCISSORS



BC320R-BC330R

Catalog Number	Tip	Blade	Length (in.)
BC320R	S/B	STR	4 1/8
BC321R	S/B	STR	4 1/2
BC323R	S/B	STR	5 1/8
BC324R	S/B	STR	5 3/4
BC325R	S/B	STR	6
BC326R	S/B	STR	6 1/2
BC327R	S/B	STR	6 7/8
BC328R	S/B	STR	7 1/4
BC330R	S/B	STR	7 7/8
BC403R	S/B	CVD	5 1/8
BC404R	S/B	CVD	5 3/4

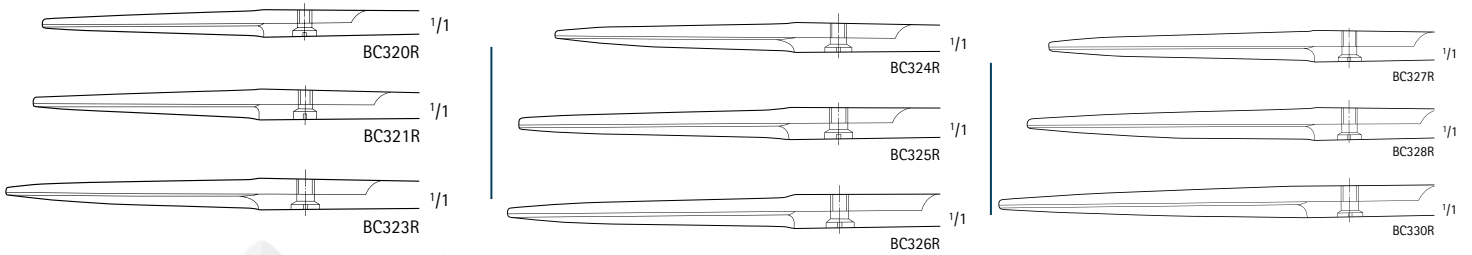

BC403R-BC404R

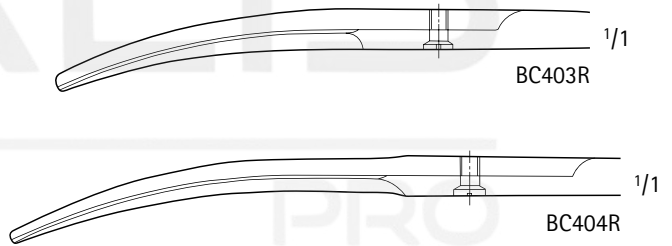

SUTURE SCISSORS



BC421R-BC428R

Catalog Number	Tip	Blade	Length (in.)
BC421R	S/B	CVD	4 1/2
BC423R	S/B	CVD	5 1/8
BC424R	S/B	CVD	5 3/4
BC425R	S/B	CVD	6
BC426R	S/B	CVD	6 1/2
BC428R	S/B	CVD	7 1/4

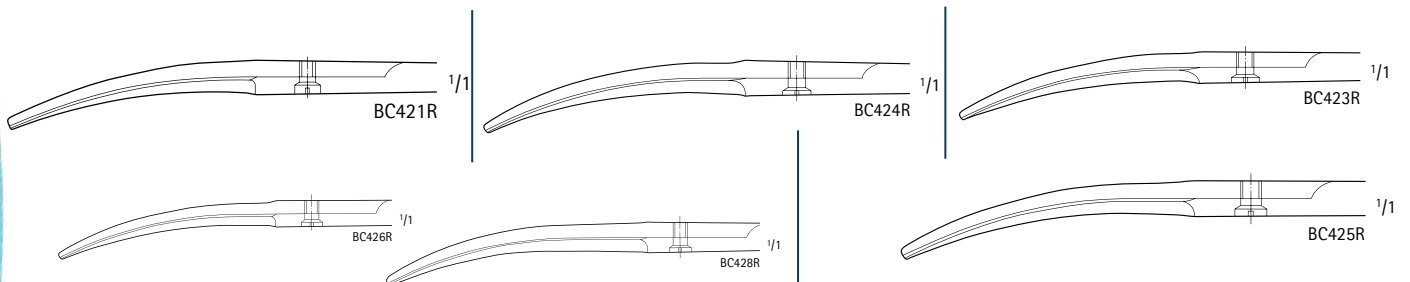

GENERAL SURGERY

Scissors

SUTURE SCISSORS



Catalog Number	Tip	Blade	Length (in.)
BC135R	B/B	CVD, DEL	4 3/4

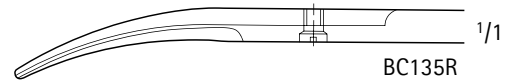

COOPER SUTURE SCISSORS

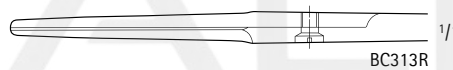

Catalog Number	Tip	Blade	Length (in.)
BC313R	B/B	STR	5 1/8
BC314R	B/B	STR	5 3/4
BC315R	B/B	STR	6
BC316R	B/B	STR	6 1/2
BC317R	B/B	STR	6 7/8
BC411R	B/B	CVD	4 1/2
BC413R	B/B	CVD	5 1/8
BC414R	B/B	CVD	5 3/4
BC415R	B/B	CVD	6
BC416R	B/B	CVD	6 1/2
BC417R	B/B	CVD	6 7/8

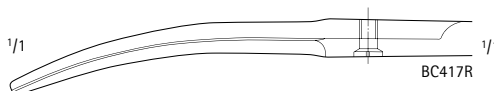
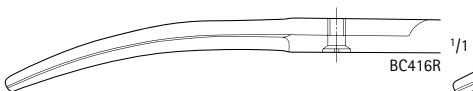
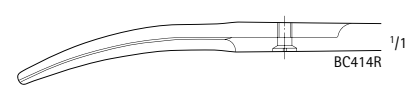
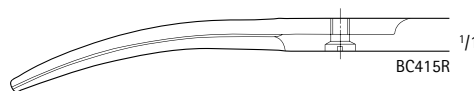
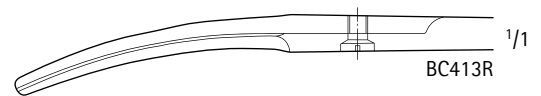
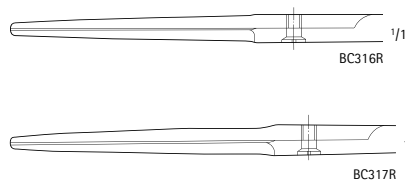
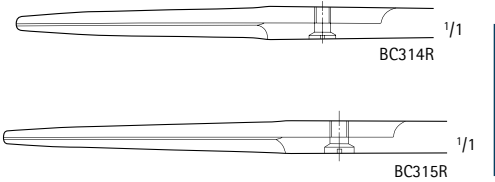

GENERAL SURGERY

Scissors

LISTER BANDAGE SCISSORS



BC848R-BC863R

Catalog Number	Blade	Length (in.)
BC848R	LONG	6 1/8
BC849R	LONG	7
BC860R	STANDARD	4 1/2
BC861R	STANDARD	5 1/2
BC862R	STANDARD	7
BC863R	STANDARD	7 7/8

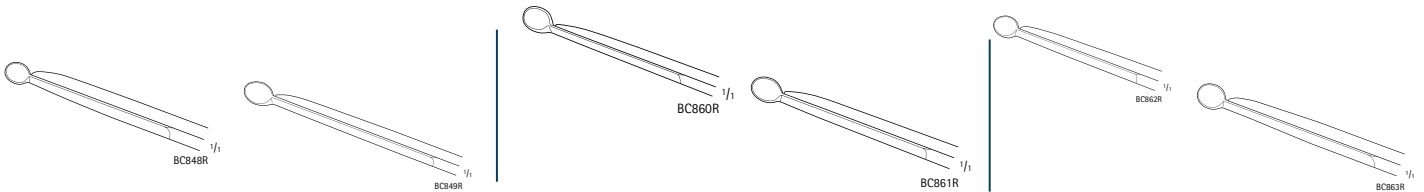

LISTER BANDAGE SCISSORS, GOLD HANDLE



MG379R



MG379R

Catalog Number	Length (in.)
MG379R	5 1/2

LISTER BANDAGE SCISSORS, W/ ONE LARGE RING



MB223



MB223

Catalog Number	Length (in.)
MB223	8

LISTER BANDAGE SCISSORS, SERRATED



BC876R, MB146R

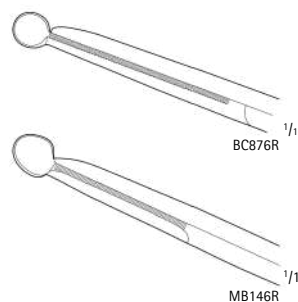

BC876R

MB146R

Catalog Number	Length (in.)
MB146R	3 1/2
BC876R	6 1/4

STILLE DISSECTING SCISSORS, ROUND BLADES



BC580R-BC581R

1/2

Catalog Number	Tip	Blade	Length (in.)
BC580R	B/B	STR	6
BC581R	B/B	CVD	6

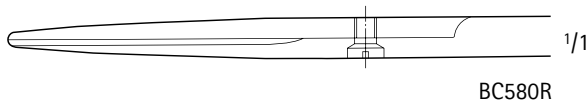

BC580R

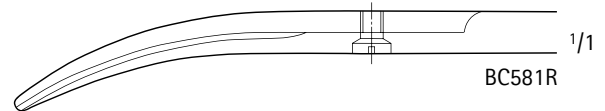

BC581R

MAYO DISSECTING SCISSORS, ROUND BLADE



BC584R-BC589R

Catalog Number	Tip	Blade	Length (in.)
BC584R	B/B	STR	6 1/2
BC585R	B/B	STR	7 7/8
BC587R	B/B	CVD	6 1/2
BC588R	B/B	CVD	7 7/8
BC589R	B/B	CVD	8 1/4

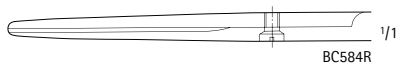

BC584R



BC588R

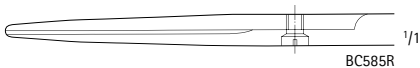

BC585R



BC587R



BC589R

MAYO-HARRINGTON DISSECTING



BC560R-BC561R

1/3

Scissors

Catalog Number	Tip	Blade	Length (in.)
BC560R	B/B	STR	9
BC561R	B/B	CVD	9

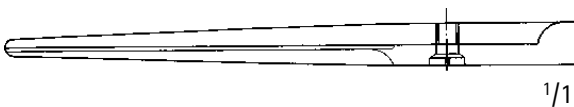

BC560R



BC561R

GENERAL SURGERY

Scissors

MAYO-HARRINGTON DISSECTING

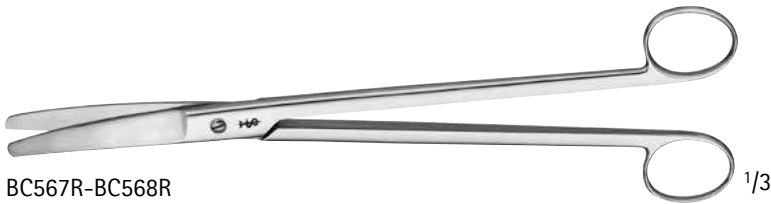

BC567R-BC568R

Scissors
Catalog Number

	Tip	Blade	Length (in.)
BC568R	B/B	STR	11
BC567R	B/B	CVD	11

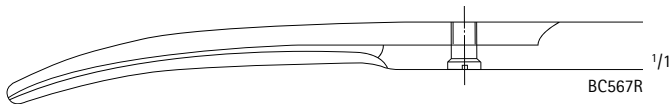

BC567R 1/3

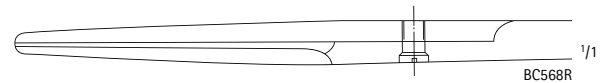

BC568R 1/1

MAYO DISSECTING SCISSORS, W/ ONE LARGE RING

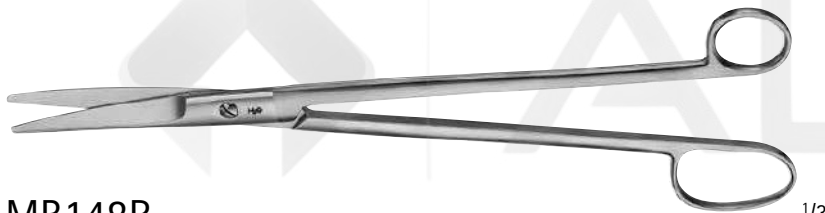

MB148R

Catalog Number	Tip	Blade	Length (in.)
MB148R	B/B	HEAVY	14

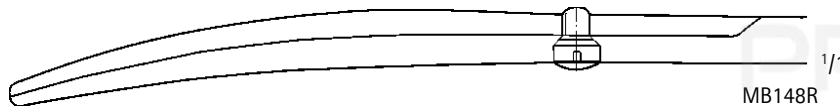

MB148R 1/1

MAYO DISSECTING SCISSORS, BEVELED BLADE

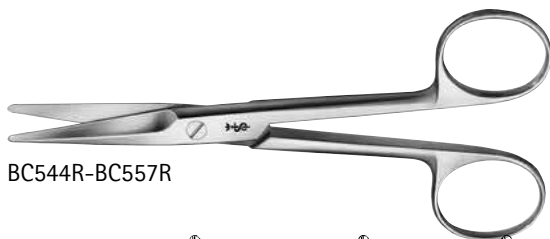

BC544R-BC557R

Catalog Number	Tip	Blade	Length (in.)
BC544R	B/B	STR	5 1/2
BC545R	B/B	STR	6 1/8
BC547R	B/B	STR	6 3/4
BC562R	B/B	STR	7 1/2
BC564R	B/B	STR	8 1/2
BC554R	B/B	CVD	5 1/2
BC555R	B/B	CVD	6 1/8
BC557R	B/B	CVD	6 3/4
BC563R	B/B	CVD	7 1/2
BC565R	B/B	CVD	8 1/2

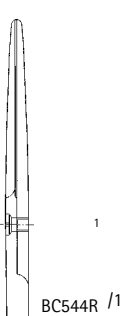

BC544R 1/1

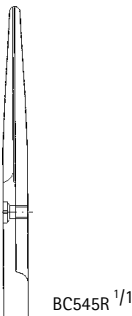

BC545R 1/1

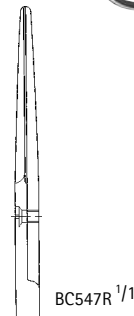

BC547R 1/1

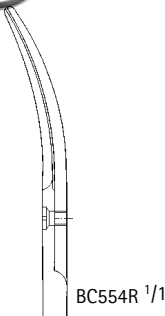

BC554R 1/1

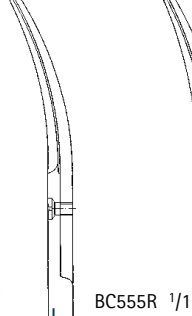

BC555R 1/1

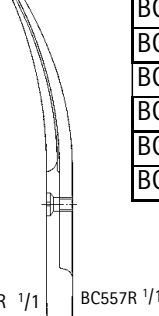

BC557R 1/1

GENERAL SURGERY

Scissors

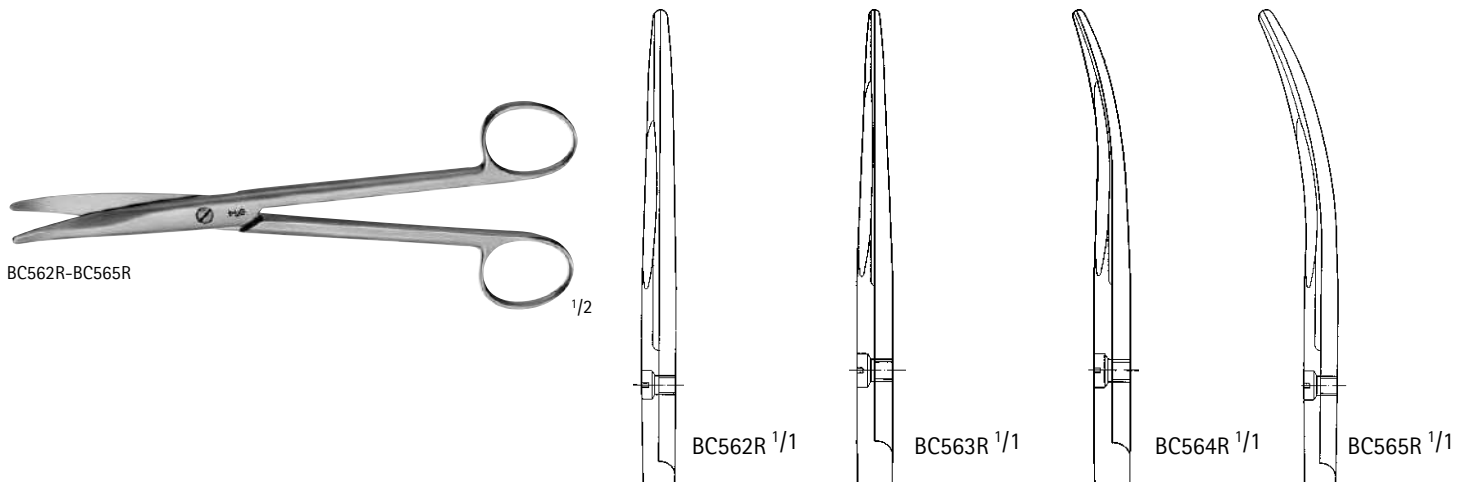

MAYO OPERATING SCISSORS

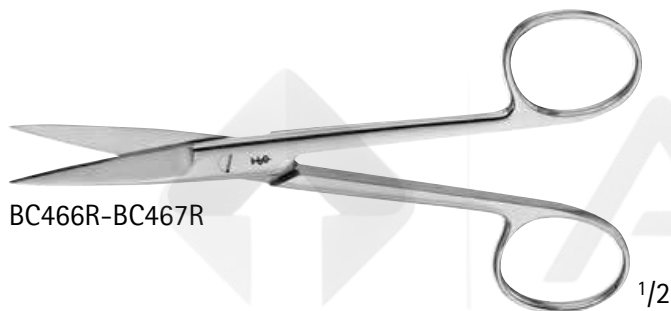

Catalog Number	Tip	Blade	Length (in.)
BC466R	S/S	STR	5 1/2
BC467R	S/S	CVD	5 1/2



MAYO DISSECTING SCISSORS, DELICATE



Catalog Number	Tip	Blade	Length (in.)
BC594R	B/B	STR	5 1/2

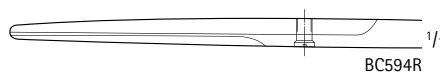

NEW'S SUTURE SCISSORS



BC804R

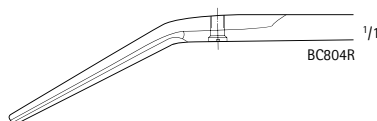

Catalog Number	Tip	Blade	Length (in.)
BC804R	B/B	ANG	5 1/2

SUTURE SCISSORS



BC806R

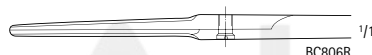

Catalog Number	Tip	Blade	Length (in.)
BC806R	B/B	STR	4 1/2

LEXER DISSECTING SCISSORS, DELICATE



BC590R-BC591R

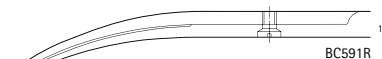
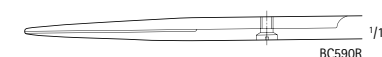

Catalog Number	Tip	Blade	Length (in.)
BC590R	B/B	STR	6 1/2
BC591R	B/B	CVD	6 1/2

MAYO-LEXER DISSECTING SCISSORS



BC592R

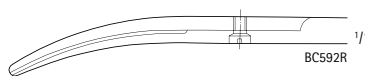

Catalog Number	Tip	Blade	Length (in.)
BC592R	B/B	CVD	6 1/2

MAYO-SIMS DISSECTING SCISSORS



Catalog Number	Tip	Blade	Length (in.)
MB149R	B/B	STR	7 3/4

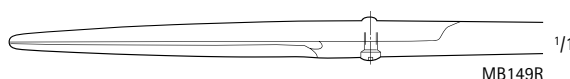

MAYO-NOBLE DISSECTING SCISSORS, BROAD BLADE



Catalog Number	Tip	Blade	Length (in.)
BC566R	B/B	STR	6 3/4
BC569R	B/B	CVD	6 3/4

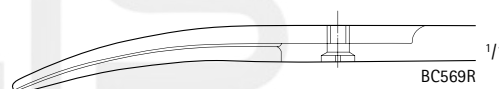
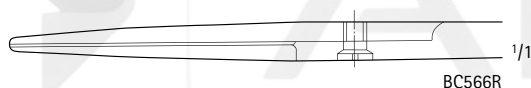

MAYO-STILLE DISSECTING SCISSORS, BEVELED BLADE



Catalog Number	Tip	Blade	Length (in.)
BC576R	B/B	STR	5 1/2
BC578R	B/B	STR	6 1/2
BC577R	B/B	CVD	5 1/2
BC579R	B/B	CVD	6 1/2

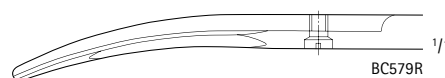
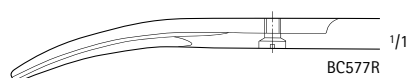
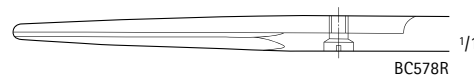
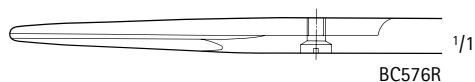

MAYO-STILLE DISSECTING SCISSORS, FLAT BLADE



Catalog Number	Tip	Blade	Length (in.)
BC570R	B/B	STR	5 1/2
BC572R	B/B	STR	6 3/4
BC573R	B/B	CVD	5 1/2
BC575R	B/B	CVD	6 3/4

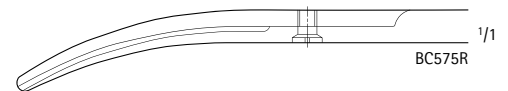
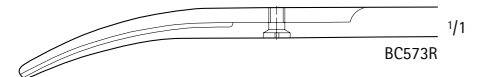
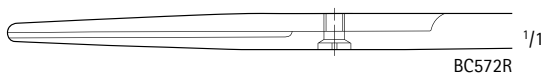
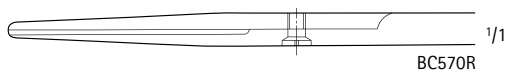

TOENNIS DISSECTING SCISSORS



Catalog Number	Tip	Blade	Length (in.)
BC633R	B/B	X-DEL, STR	7
BC634R	B/B	DEL, STR	7
BC635R	B/B	DEL, CVD	7

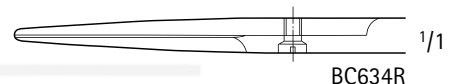
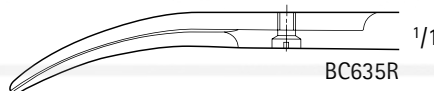

NERVE DISSECTING SCISSORS

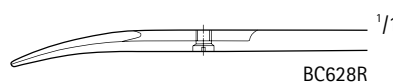

Catalog Number	Tip	Blade	Length (in.)
BC628R	S/S	CVD	6

TOENNIS-ADSON DISSECTING SCISSORS

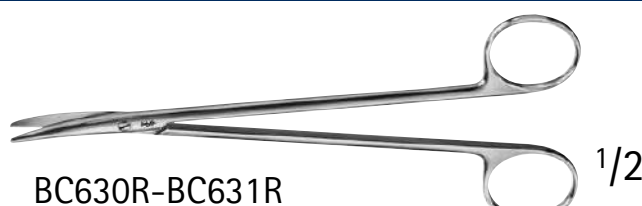

Catalog Number	Tip	Blade	Length (in.)
BC630R	X-DEL	CVD	6 7/8
BC631R	DEL	CVD	6 7/8

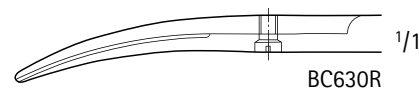

Scissors

METZENBAUM DISSECTING SCISSORS



BC601R-BC607R

Catalog Number	Tip	Blade	Length (in.)
BC601R	B/B	STR	
BC602R	B/B	STR	
BC604R	B/B	STR	
BC605R	B/B	CVD	
BC606R	B/B	CVD	
BC607R	B/B	CVD	

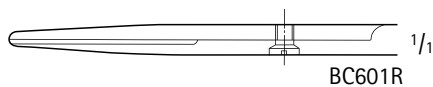

BC601R

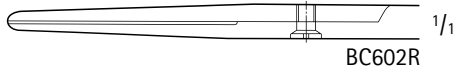

BC602R

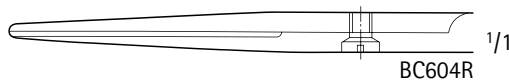

BC604R

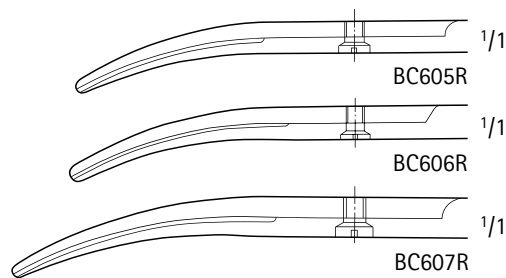

BC607R

BABY METZENBAUM DISSECTING SCISSORS, DELICATE



BC600R-BC603R

Catalog Number	Tip	Blade	Length (in.)
BC600R	B/B	STR	5 3/4
BC603R	B/B	CVD	5 3/4

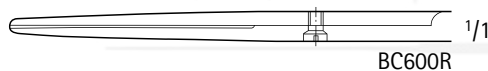

BC600R

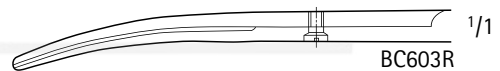

BC603R

BABY METZENBAUM DISSECTING SCISSORS



BC022R-BC023R

Catalog Number	Tip	Blade	Length (in.)
BC022R	B/B	STR	5 3/4
BC023R	B/B	CVD	5 3/4

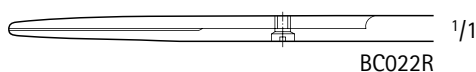

BC022R

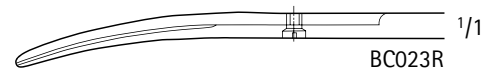

BC023R

METZENBAUM SCISSORS, DELICATE

MA464R-MA465R



Catalog Number	Tip	Blade	Length (in.)
MA464R	B/B	CVD	5 1/2
MA465R	B/B	CVD	8

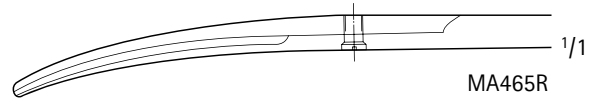

NELSON-METZENBAUM DISSECTING SCISSORS

BC611R-BC619R, MB926R

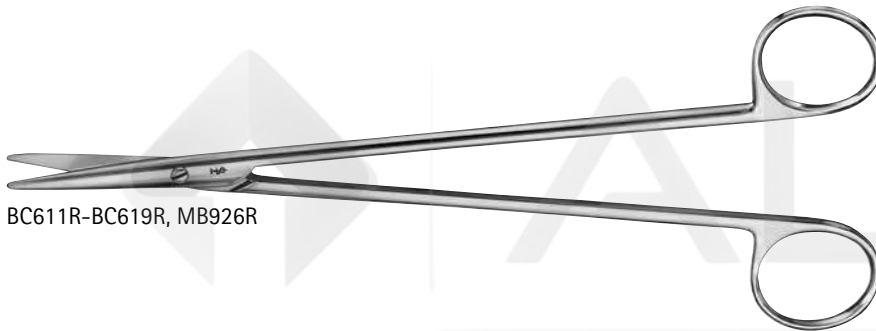

Catalog Number	Tip	Blade	Length (in.)
BC611R	B/B	STR	9
BC612R	B/B	STR	9 3/4
BC613R	B/B	STR	11 1/4
BC614R	B/B	STR	12
BC615R	B/B	CVD	9
BC616R	B/B	CVD	9 3/4
BC618R	B/B	CVD	11 1/4
BC619R	B/B	CVD	12
MB926R	B/B	CVD	16

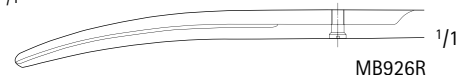
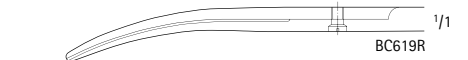
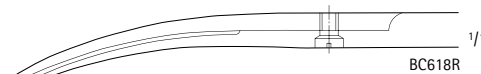
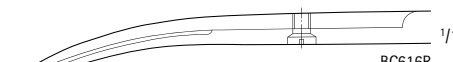
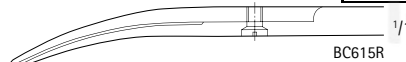
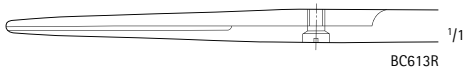
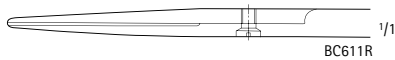

NELSON-METZENBAUM DISSECTING SCISSORS, DELICATE



Catalog Number	Tip	Blade	Length (in.)
BC625R	B/B	CVD	13 3/4

BC625R



BC625R

WELLER DISSECTING SCISSORS



Catalog Number	Tip	Blade	Length (in.)
BC620R	B/B	HEAVY-CVD	11

BC620R

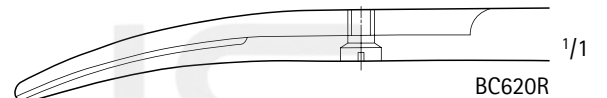

BC620R

ABDOMINAL SCISSORS



Catalog Number	Tip	Blade	Length (in.)
BC774R	B/B	STR	7

BC774R

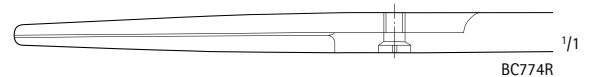

BC774R

RECTAL SCISSORS



Catalog Number	Tip	Blade	Length (in.)
BC617R	B/B	HEAVY-CVD	12 3/4

BC617R

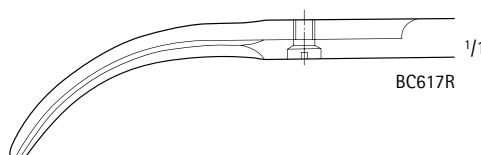

BC617R

LLOYD-DAVIES RECTAL SCISSORS



BC621R

Catalog Number	Tip	Blade	Length (in.)
BC621R	B/B	CVD	10 5/8

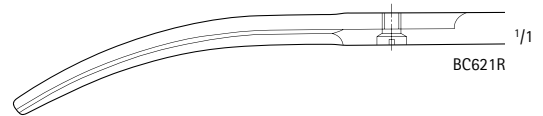

STELZNER RECTAL SCISSORS



BC622R-BC623R

Catalog Number	Tip	Blade	Length (in.)
BC622R	B/B	STR	12 1/4
BC623R	B/B	CVD	12 1/4



BC622R



BC623R

MUELLER RECTAL SCISSORS

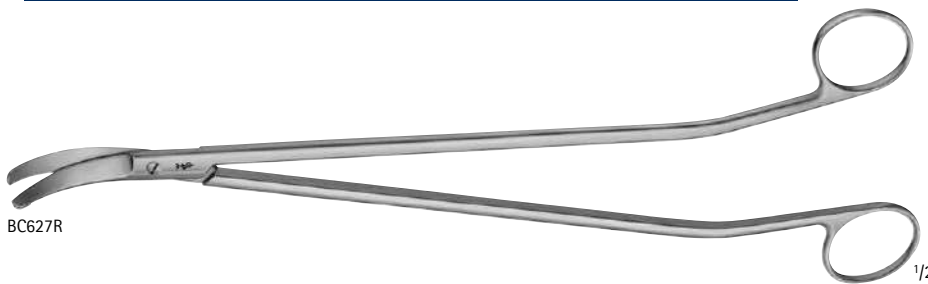

BC627R

Catalog Number	Tip	Blade	Length (in.)
BC627R	B/B	CVD	12 3/4

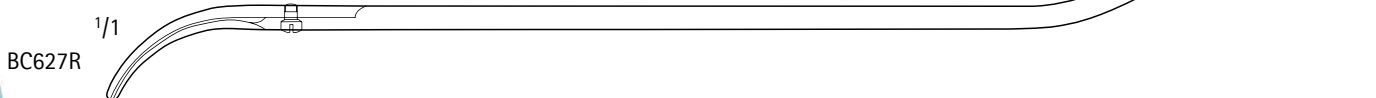

BC627R

HARVEY WIRE SCISSORS

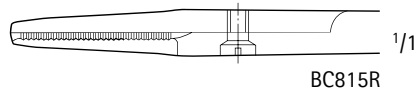

Catalog Number	Tip	Blade	Length (in.)
BC815R	B/B	SERR	5

WIRE CUTTING SCISSORS

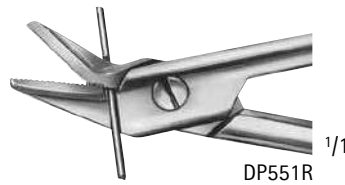
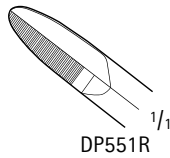

Catalog Number	For Wire Size	Length (in.)
DP551R	SOFT, UP TO 1.2MM AND HARD, UP TO 0.6 MM	4 3/4

IRIS SCISSORS

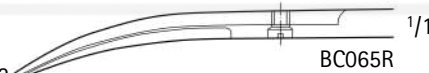

Catalog Number	Tip	Blade	Length (in.)
BC100R	S/S	STR	3 1/2
BC110R	S/S	STR	4 1/4
BC106R	S/S	STR	4 1/2
BC064R	S/S	STR	4 3/4
BC101R	S/S	CVD	3 1/2
BC111R	S/S	CVD	4 1/4
BC107R	S/S	CVD	4 1/2
BC065R	S/S	CVD	4 3/4
BC112R	S/B	STR	4 1/4
BC113R	S/B	CVD	4 1/4
BC117R	S/S	LAT-ANG	4 1/4

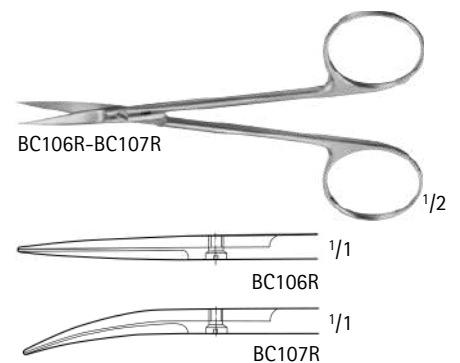
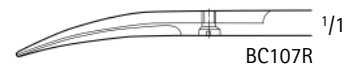
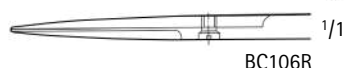
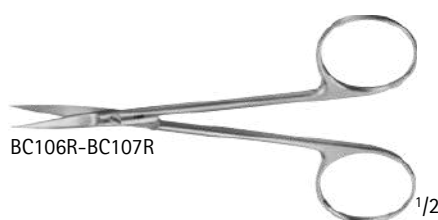
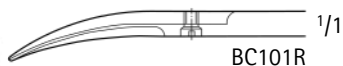
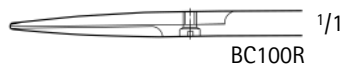

Scissors



BC110R-BC117R

1/2

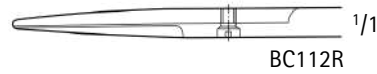

BC112R

1/1

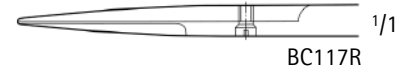

BC117R

1/1

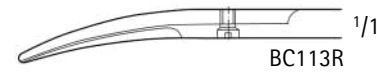

BC113R

1/1



BC117R

1/1

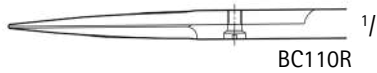

BC110R

1/1

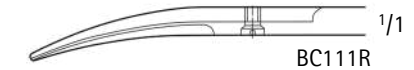

BC111R

1/1

REYNOLDS-JAMESON TENOTOMY SCISSORS



BC015R



BC015R

1/1

1/2

Catalog Number	Tip	Blade	Handle	Length (in.)
BC015R	B/B	CVD	SQUARE	5 1/2

STRABISMUS SCISSORS



BC164R-BC165R

1/2

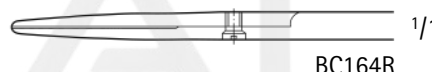

BC164R

1/1

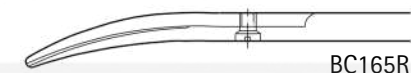

BC165R

1/1

Catalog Number	Tip	Blade	
BC164R	B/B	STR	
BC165R	B/B	CVD	

RAGNELL DISSECTING SCISSORS

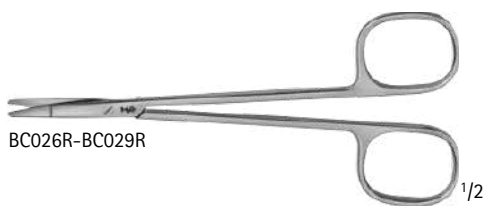

BC026R-BC029R

1/2

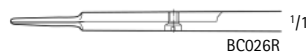

BC026R

1/1

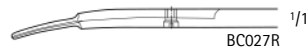

BC027R

1/1



BC029R

1/1

Catalog Number	Tip	Blade	Length (in.)
BC026R	B/B	STR	5 1/4
BC027R	B/B	CVD	5 1/4
BC029R	B/B	CVD	6

CHADWICK SCISSORS, DELICATE



BC153R

1/2

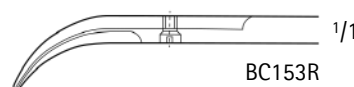

BC153R

1/1

Catalog Number	Tip	Blade	Length (in.)
BC153R	S/S	CVD	4 1/2

Scissors

LA GRANGE SCISSORS

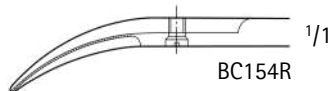

Catalog Number	Tip	Blade	Length (in.)
BC154R	S/S	1-SERR	4 1/4

KELLY SCISSORS

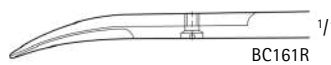
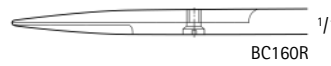

Catalog Number	Tip	Blade	Length (in.)
BC160R	S/S	STR	6 7/8
BC161R	S/S	CVD	6 7/8

ROCHESTER-FERGUSON SCISSORS



Catalog Number	Tip	Blade	Length (in.)
MG220R	B/B	ANG FLAT	7

Alis Pro Tungsten Carbide Scissors ■ Excellent cutting accuracy ■ Long working life ■ Gold-plated rings

ALIS PRO TC SUTURE SCISSORS



Catalog Number	Tip	Blade	Length (in.)
BC228R	S/S	STR	5 3/4
BC224R	S/B	STR	5 3/4
BC234R	S/B	CVD	5 3/4

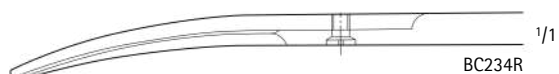
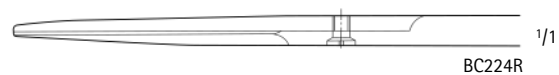

Scissors

ALIS PRO TC OPERATING SCISSORS



BC236R-MB171R

Catalog Number	Tip	Blade	Length (in.)
BC236R	S/S	STR	5 3/4
MB171R	S/S	CVD	5 3/4

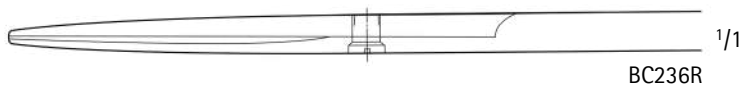

BC236R



MB171R

ALIS PRO TC WIRE CUTTING SCISSORS



DP552R

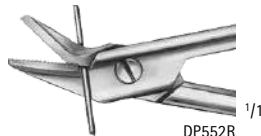

DP552R



DP552R

Catalog Number	Blade	For Wire Size	Length (in.)
DP552R	1-SERR	SOFT, UP TO 1.2 MM AND HARD, UP TO 0.8 MM	4 3/4

ALIS PRO TC MAYO-LEXER DISSECTING SCISSORS, ROUND BLADES



1/2



BC284R

Catalog Number	Tip	Blade	
BC284R	B/B	CVD	

ALIS PRO TC MAYO DISSECTING SCISSORS, ROUND BLADES



BC240R-BC243R



BC240R

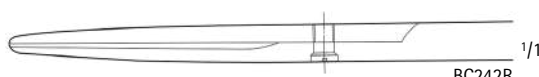

BC242R



BC241R



BC243R

Catalog Number	Tip	Blade	Length (in.)
BC240R	B/B	STR	5 1/2
BC242R	B/B	STR	6 3/4
BC241R	B/B	CVD	5 1/2
BC243R	B/B	CVD	6 3/4

Scissors

ALIS PRO TC MAYO DISSECTING SCISSORS, BEVELED BLADES



BC250R-BC253R

Catalog Number	Tip	Blade	Length (in.)
BC250R	B/B	STR	5 1/2
BC252R	B/B	STR	6 3/4
BC251R	B/B	CVD	5 1/2
BC253R	B/B	CVD	6 3/4

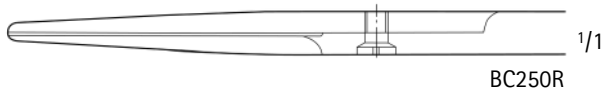

BC250R

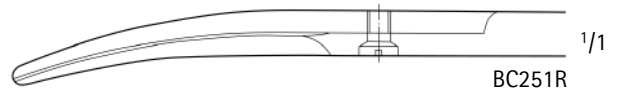

BC251R

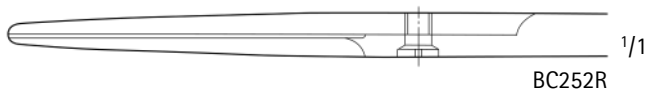

BC252R

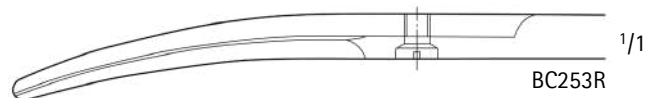

BC253R

ALIS PRO TC MAYO DISSECTING SCISSORS

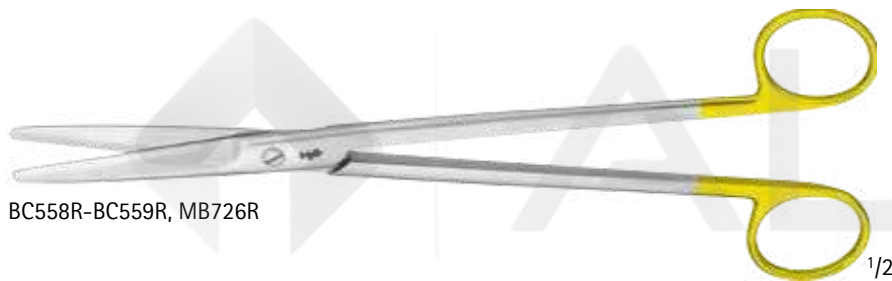

BC558R-BC559R, MB726R

Catalog Number	Tip	Blade	Length (in.)
BC558R	B/B	STR	9
MG215R	B/B	STR	14
BC559R	B/B	CVD	9
MB726R	B/B	CVD	14



BC558R



MB726R



BC559R



MG215R

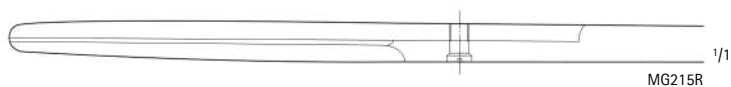

MG215R

Scissors

ALIS PRO TC METZENBAUM DISSECTING SCISSORS, DELICATE

Catalog Number	Tip	Blade	Length (in.)
MB205R	S/S	STR	9 1/4
MB207R	S/S	CVD	5 3/4
MD496	S/S	CVD	7
MB206R	S/S	CVD	9 1/4

MB205R-MB207R, MD496

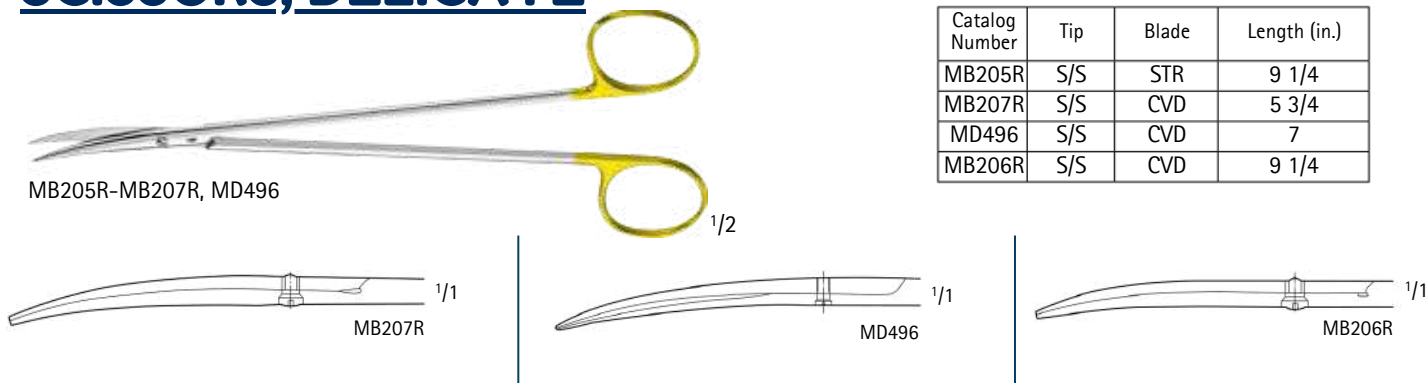

ALIS PRO TC METZENBAUM DISSECTING SCISSORS

Catalog Number	Tip	Blade	Length (in.)
BC260R	B/B	STR	5 3/4
BC262R	B/B	STR	7
BC261R	B/B	CVD	5 3/4
BC263R	B/B	CVD	7
BC265R	B/B	CVD	7 7/8

BC260R-BC265R

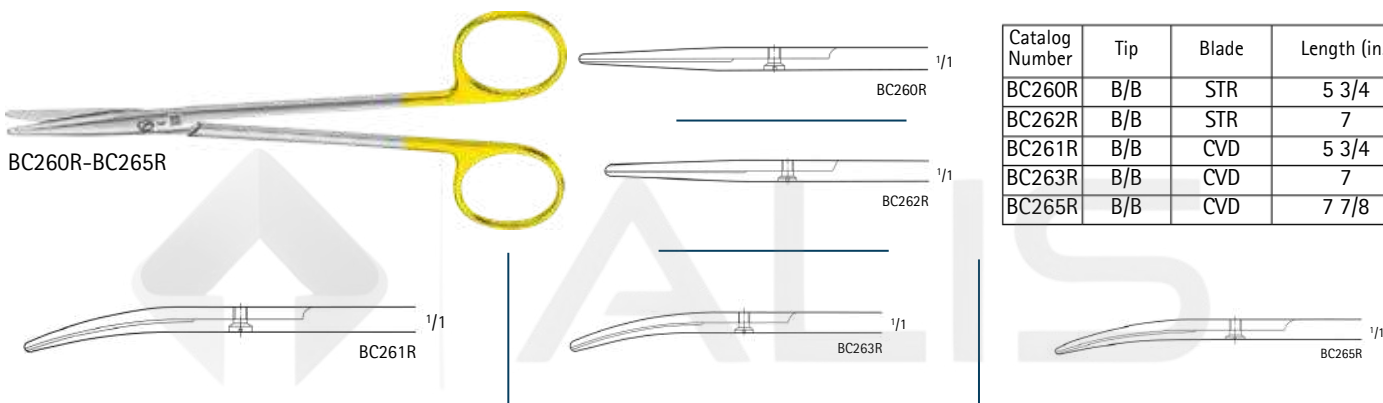

ALIS PRO TC METZENBAUM DISSECTING SCISSORS

Catalog Number	Tip	Blade	Length (in.)
BC287R	B/B	CVD	9

BC287R

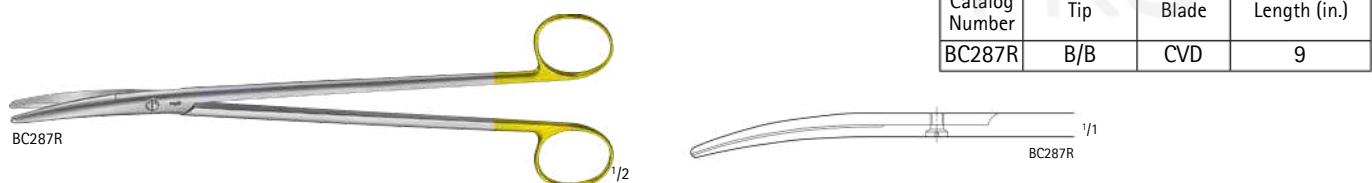

ALIS PRO TC METZENBAUM DISSECTING SCISSORS, DELICATE

Catalog Number	Tip	Blade	Length (in.)
BC270R	B/B	STR	7
BC274R	B/B	STR	7 7/8
BC276R	B/B	STR	9
BC271R	B/B	CVD	7
BC275R	B/B	CVD	7 7/8
BC277R	B/B	CVD	9

BC270R-BC277R

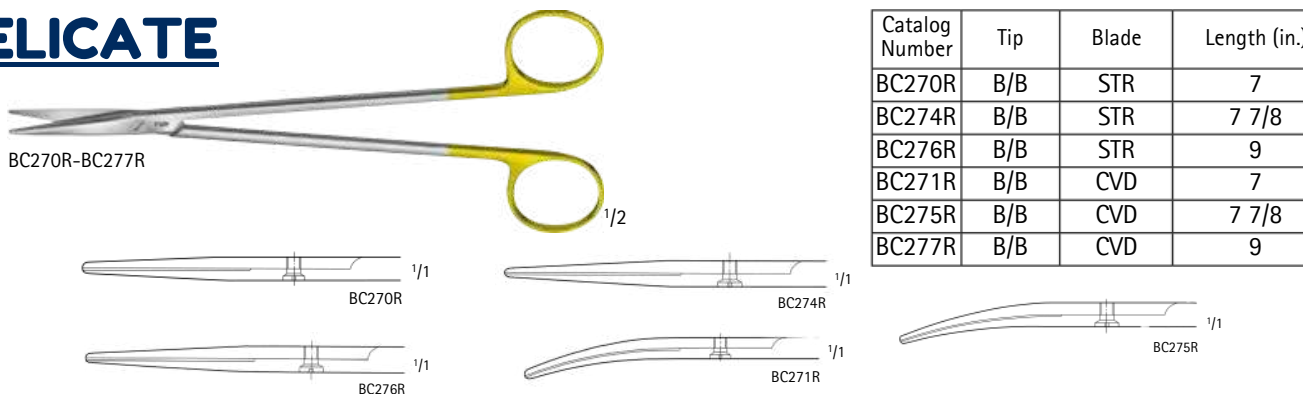

Scissors

ALIS PRO TC BABY METZENBAUM DISSECTING SCISSORS, DELICATE

Catalog Number	Tip	Blade	Length (in.)
BC258R	B/B	STR	5 3/4
BC259R	B/B	CVD	5 3/4



BC258R-BC259R

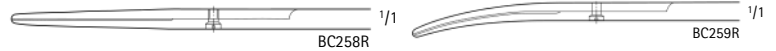

ALIS PRO TC NELSON-METZENBAUM DISSECTING SCISSORS

Catalog Number	Tip	Blade	Length (in.)
BC266R	B/B	STR	9
BC267R	B/B	CVD	9
BC279R	B/B	CVD	10 1/4
BC281R	B/B	CVD	11
BC282R	B/B	CVD	11 1/4
BC289R	B/B	CVD	11 3/4
BC285R	B/B	CVD	13 3/4



BC266R-BC285R

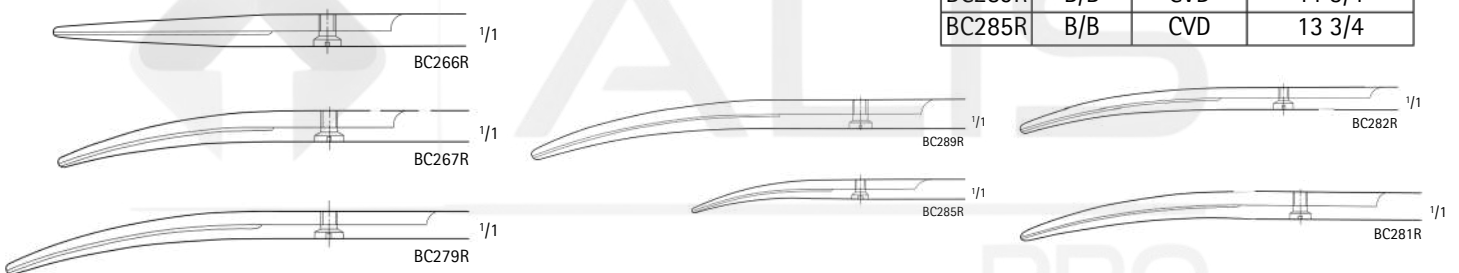

ALIS PRO TC TOENNIS-ADSON DISSECTING SCISSORS, DELICATE

Catalog Number	Tip	Blade	Length (in.)
BC273R	B/B	CVD	6 7/8



BC273R

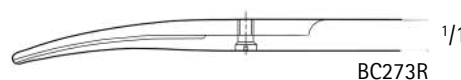

Scissors

ALIS PRO TC LEXER DISSECTING SCISSORS, DELICATE

Catalog Number	Tip	Blade	Length (in.)
BC283R	B/B	CVD	6 1/2

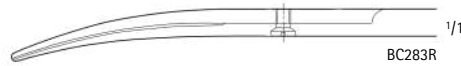

Wavecut

■ Wavecut scissors have one serrated cutting edge to prevent tissue from slipping.

The W after the item number indicates the scissors are the wavecut style, e.g. BC211W.

ALIS PRO TC MAYO WAVECUT DISSECTING SCISSORS, BEVELED BLADES

Catalog Number	Tip	Blade	Length (in.)
BC253W	B/B	CVD	6 3/4



ALIS PRO TC BABY METZENBAUM WAVECUT DISSECTING SCISSORS, DELICATE

Catalog Number	Tip	Blade	Length (in.)
BC259W	B/B	CVD	5 3/4

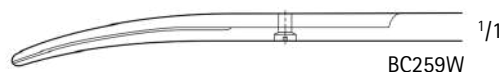

Scissors

ALIS PRO TC METZENBAUM WAVECUT DISSECTING SCISSORS



BC261W-BC265W

Catalog Number	Tip	Blade	Length (in.)
BC261W	B/B	CVD	5 3/4
BC263W	B/B	CVD	7
BC265W	B/B	CVD	7 7/8

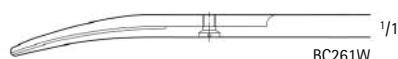

BC261W

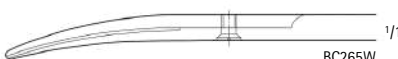

BC265W



BC263W

ALIS PRO TC METZENBAUM WAVECUT DISSECTING SCISSORS, DELICATE



BC271W-BC277W

Catalog Number	Tip	Blade	Length (in.)
BC271W	B/B	CVD	7
BC275W	B/B	CVD	7 7/8
BC277W	B/B	CVD	9



BC271W

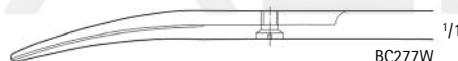

BC277W



BC275W

ALIS PRO TC METZENBAUM WAVECUT DISSECTING SCISSORS, HEAVY



BC287W

Catalog Number	Tip	Blade	Length (in.)
BC287W	B/B	CVD	9



BC287W

ALIS PRO TC TOENNIS-ADSON WAVECUT DISSECTING SCISSORS



BC273W

Catalog Number	Tip	Blade	Length (in.)
BC273W	B/B	CVD	6 7/8

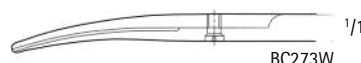

BC273W

Scissors

ALIS PRO TC NELSON-METZENBAUM WAVECUT DISSECTING SCISSORS

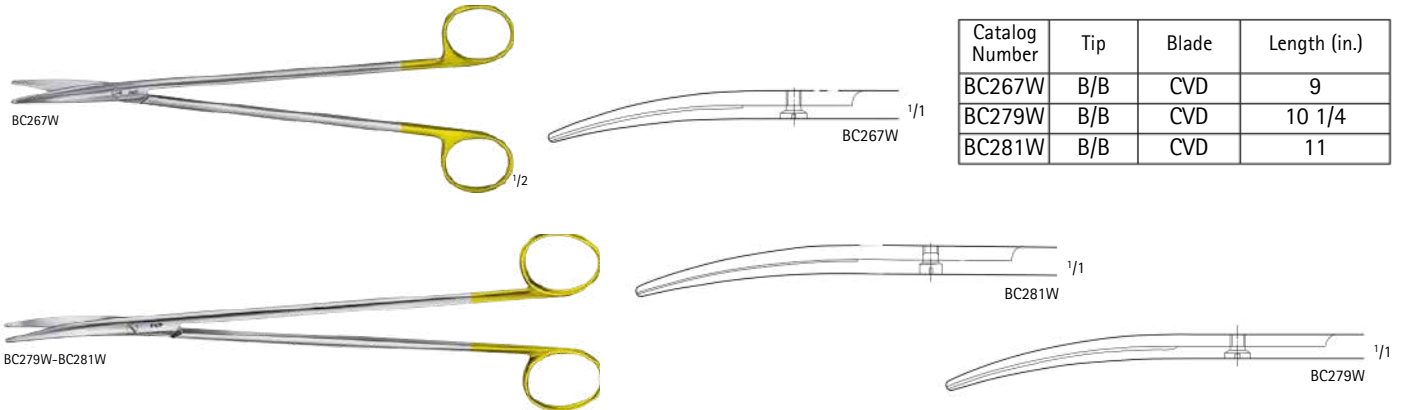

Catalog Number	Tip	Blade	Length (in.)
BC267W	B/B	CVD	9
BC279W	B/B	CVD	10 1/4
BC281W	B/B	CVD	11

ALIS PRO TC MAYO-LEXER WAVECUT SCISSORS

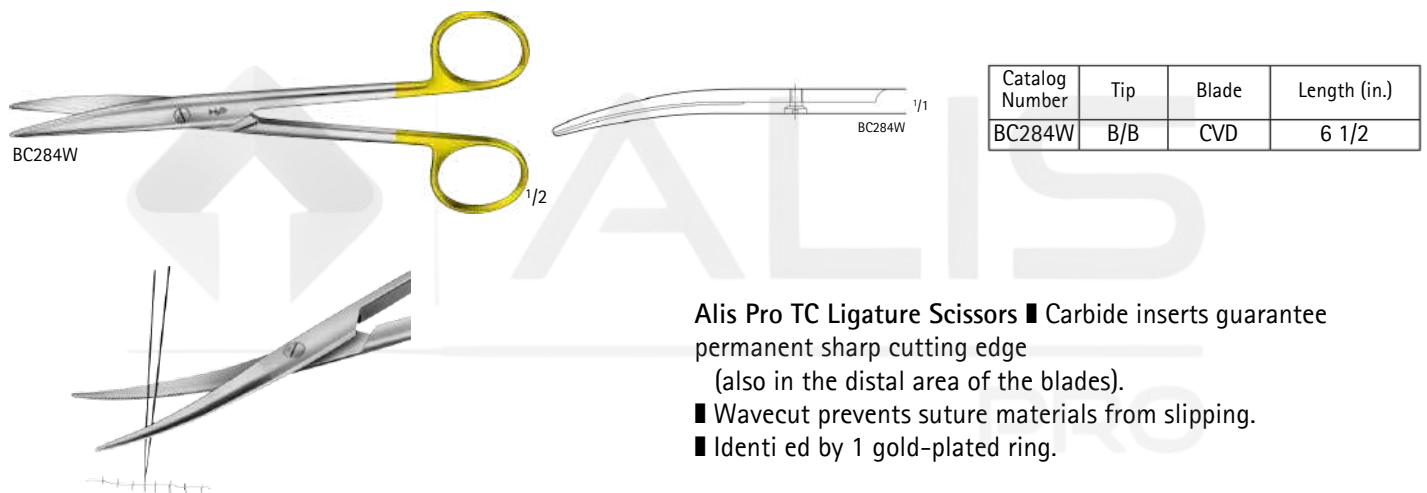

Catalog Number	Tip	Blade	Length (in.)
BC284W	B/B	CVD	6 1/2

- Alis Pro TC Ligature Scissors ■ Carbide inserts guarantee permanent sharp cutting edge (also in the distal area of the blades).
 ■ Wavecut prevents suture materials from slipping.
 ■ Identified by 1 gold-plated ring.

ALIS PRO TC LIGATURE WAVECUT SCISSORS

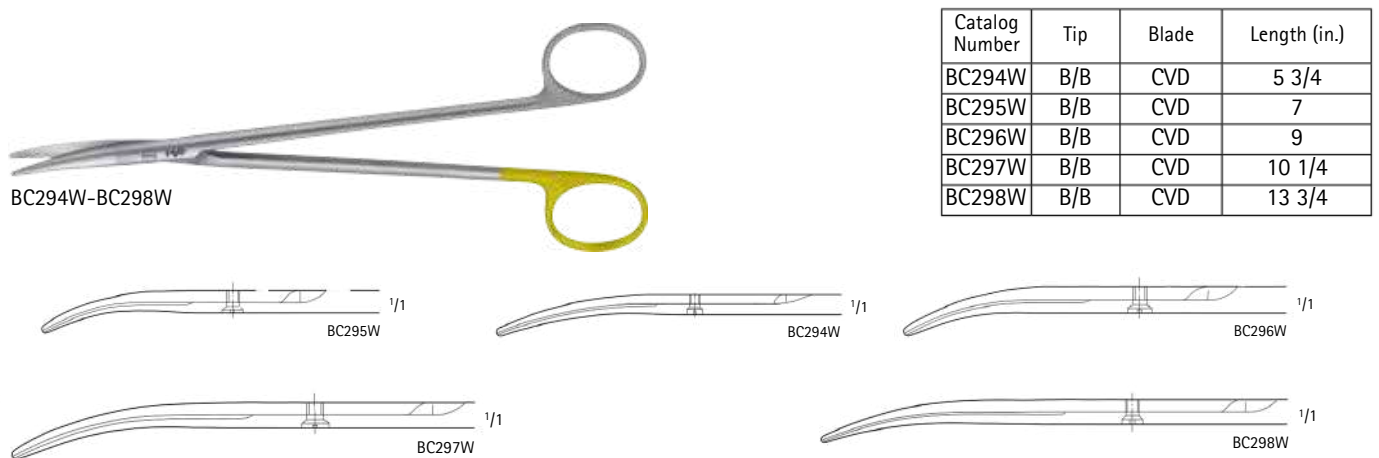

Catalog Number	Tip	Blade	Length (in.)
BC294W	B/B	CVD	5 3/4
BC295W	B/B	CVD	7
BC296W	B/B	CVD	9
BC297W	B/B	CVD	10 1/4
BC298W	B/B	CVD	13 3/4

Scissors

SuperCut Scissors

Your everyday black handle scissors

- Microtome Edge
- Razor sharp cutting edge facilitates gentle cutting with minimal force
- Wavecut Blade
- Prevents tissue from slipping out during the cutting process

For more information about SuperCut Scissors see brochure number DOC821.

IRIS SUPERCUT SCISSORS, DELICATE



BC900R-BC901R

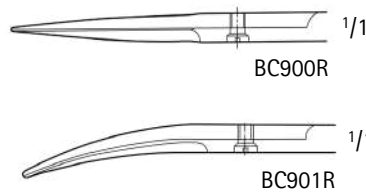

Catalog Number	Tip	Blade	Length (in.)
BC900R	S/S	STR	4 1/4
BC901R	S/S	CVD	4 1/4

SUPERCUT PLASTIC STANDARD SCISSORS



BC903R

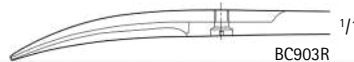

Catalog Number	Tip	Blade	Length (in.)
BC903R	S/S	CVD	5

STEVENS SUPERCUT SCISSORS



BC904R-BC905R

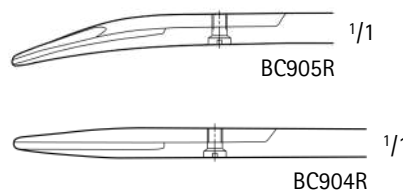

Catalog Number	Tip	Tip Size (mm)	Blade	Length (in.)
BC904R	B/B	12	STR	4 1/8
BC905R	B/B	12	CVD	4 1/8

Scissors

STEVENS SUPERCUT SCISSORS (CONTINUED)



BC906R-BC907R

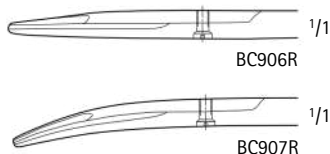

Catalog Number	Tip	Tip Size (mm)	Blade	Length (in.)
BC906R	B/B	13	STR	4 1/4
BC907R	B/B	13	CVD	4 1/4

GOLDMANN-FOX SUPERCUT SCISSORS



BC909R



Catalog Number	Tip	Blade	Length (in.)
BC909R	S/S	CVD	5 1/8

JAMESON SUPERCUT SCISSORS, DELICATE



BC911R



Catalog Number	Tip	Blade	Length (in.)
BC911R	B/B	CVD	5 1/8
BC915R	B/B	CVD	6
BC919R	B/B	CVD	7



BC915R



BC919R



BC919R

JOSEPH SUPERCUT SCISSORS, DELICATE



BC916R-BC917R



BC916R

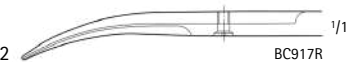

BC917R

Catalog Number	Tip	Blade	Length (in.)
BC916R	S/S	STR	6
BC917R	S/S	CVD	6

Scissors

GORNEY SUPERCUT SCISSORS, DELICATE

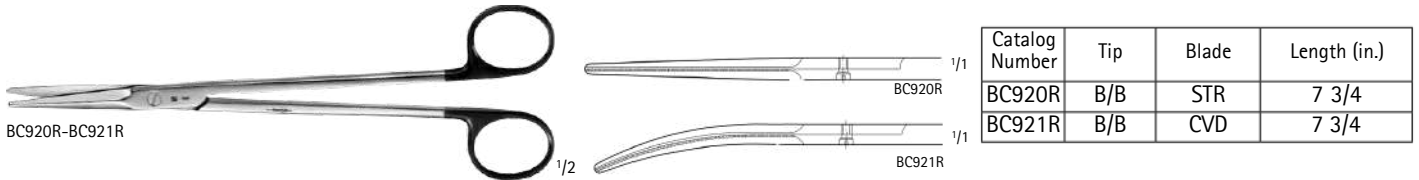

KAYE SUPERCUT FACELIFT SCISSORS, DELICATE

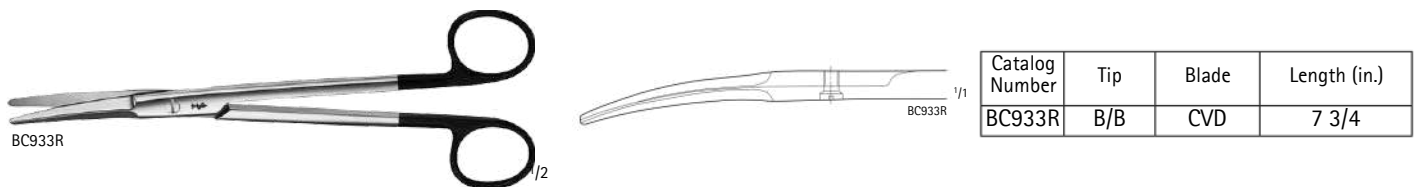

MAYO SUPERCUT SCISSORS, DELICATE

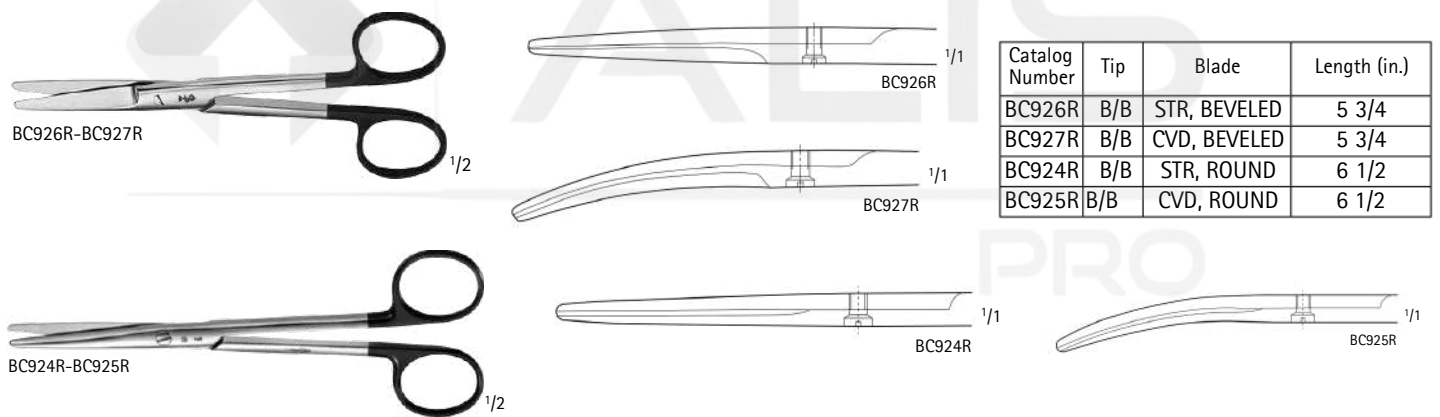

MAYO SUPERCUT SCISSORS, BEVELED

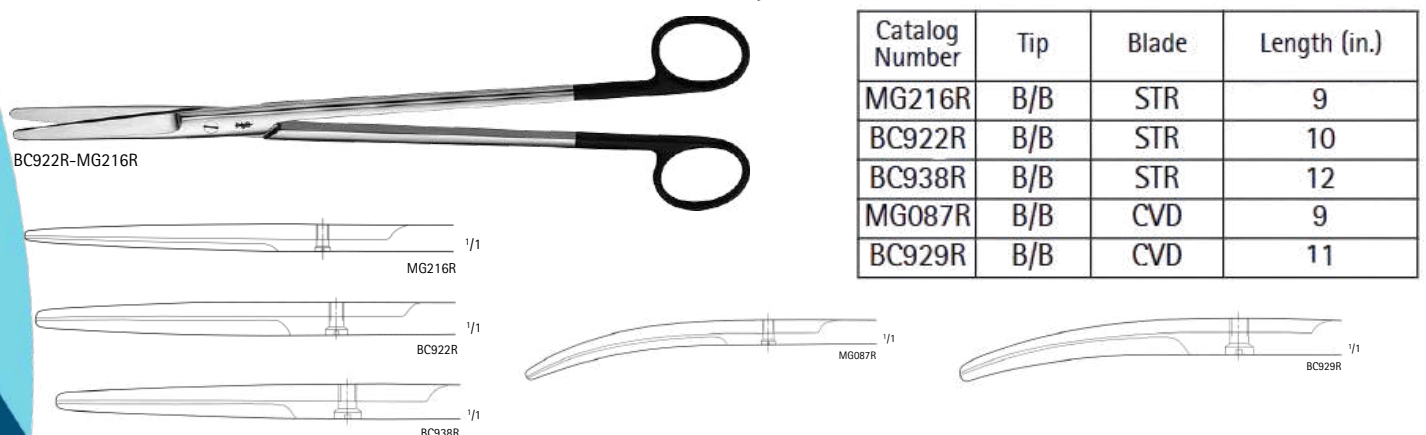

Scissors

BABY METZENBAUM SUPERCUT SCISSORS, DELICATE



BC930R-BC931R

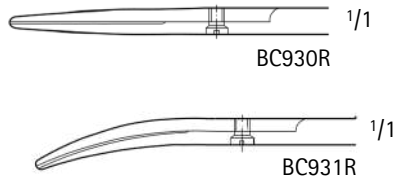

Catalog Number	Tip	Blade	Length (in.)
BC930R	B/B	STR	4 1/2
BC931R	B/B	CVD	4 1/2

METZENBAUM SUPERCUT SCISSORS, DELICATE



BC934R-BC937R

Catalog Number	Tip	Blade	Length (in.)
BC934R	B/B	STR	5 3/4
BC936R	B/B	STR	7
BC935R	B/B	CVD	5 3/4
BC937R	B/B	CVD	7

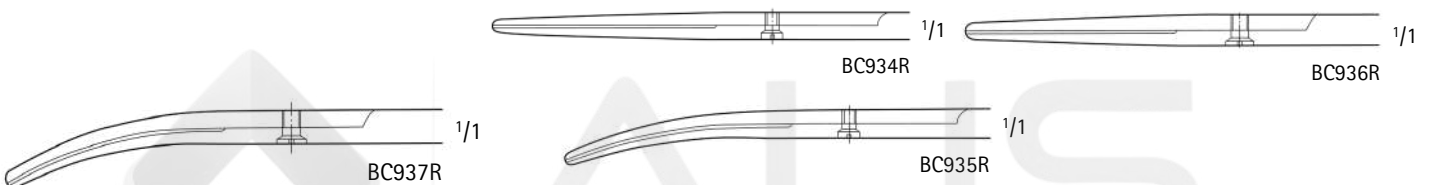

METZENBAUM SUPERCUT SCISSORS, DELICATE



BC945R-BC953R

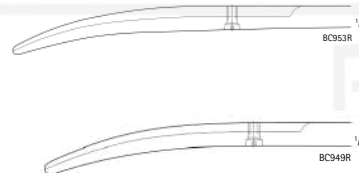

Catalog Number	Tip	Blade	Length (in.)
BC945R	B/B	CVD	9
BC947R	B/B	CVD	10 1/4
BC949R	B/B	CVD	11 1/4
BC951R	B/B	CVD	11 3/4
BC953R	B/B	CVD	14

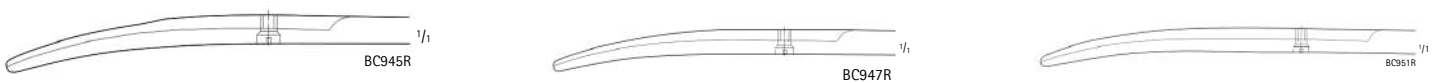

POTTS-SMITH SUPERCUT SCISSORS



BC957R-BC959R

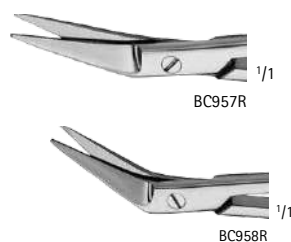

Catalog Number	Tip	Blade Angle	Blade Size (mm)	Length (in.)
BC957R	B/B	25°	22	7 1/2
BC958R	B/B	45°	20	7 1/4
BC959R	B/B	60°	19	7

Scissors

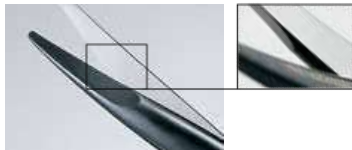

Microtome Edge

e.g. BC211WB.



Alis Pro Supreme Cut Scissors ■ Alis Pro

The combination of the renowned Aesculap Tungsten Carbide technology with the Aesculap Alis Pro coating results in an extremely high surface hardness and therefore high wear resistance in daily hospital use.

■ Microtome edge

The extremely sharp cutting edge of the scissors blade facilitates gentle cutting of tissue with minimal use of force.

■ Wavecut prevents tissue from slipping out during the cutting process. ■ The WB after the item number indicates the Alis Pro scissors are the wavecut style,

For more information about Alis Pro Supreme Cut Scissors see our brochure number DOC637.

ALIS PRO MAYO DISSECTING SCISSORS



1/2



BC252B

1/1



BC253B, BC253WB

Catalog Number	Tip	Blade	Length (in.)
BC252B	B/B	STR	6 3/4
BC253B	B/B	CVD	6 3/4
BC253WB	B/B	CVD	6 3/4

ALIS PRO MAYO-LEXER DISSECTING SCISSORS



1/2



BC284B-BC284WB

BC284B-BC284WB

Catalog Number	Tip	Blade	Length (in.)
BC284B	B/B	CVD	6 1/2
BC284WB	B/B	CVD	6 1/2

ALIS PRO LEXER DISSECTING SCISSORS



1/2



BC283B-BC283WB

BC283B-BC283WB

Catalog Number	Tip	Blade	Length (in.)
BC283B	B/B	DEL, CVD	6 1/2
BC283WB	B/B	DEL, CVD	6 1/2

ALIS PRO IRIS DISSECTING SCISSORS



1/2



BC210B

1/1



BC211B, BC211WB

BC210B-BC211WB

Catalog Number	Tip	Blade	Length (in.)
BC210B	S/S	STR	4 1/4
BC211B	S/S	CVD	4 1/4
BC211WB	S/S	CVD	4 1/4

Scissors

ALIS PRO TOENNIS-ADSON DISSECTING SCISSORS



Catalog Number	Tip	Blade	Length (in.)
BC273B	B/B	DEL, CVD	6 7/8
BC273WB	B/B	DEL, CVD	6 7/8

ALIS PRO METZENBAUM DISSECTING SCISSORS



Catalog Number	Tip	Blade	Length (in.)
BC261B	B/B	CVD	5 3/4
BC261WB	B/B	CVD	5 3/4
BC263B	B/B	CVD	7
BC263WB	B/B	CVD	7
BC271B	B/B	DEL, CVD	7
BC271WB	B/B	DEL, CVD	7
BC265B	B/B	CVD	7 7/8
BC265WB	B/B	CVD	7 7/8
BC275B	B/B	DEL, CVD	7 7/8
BC275WB	B/B	DEL, CVD	7 7/8
BC267B	B/B	CVD	9
BC267WB	B/B	CVD	9
BC277B	B/B	DEL, CVD	9
BC277WB	B/B	DEL, CVD	9

ALIS PRO NELSON-METZENBAUM DISSECTING SCISSORS



Catalog Number	Tip	Blade	Length (in.)
BC279B	B/B	DEL, CVD	10 1/4
BC279WB	B/B	DEL, CVD	10 1/4
BC281B	B/B	DEL, CVD	11
BC281WB	B/B	DEL, CVD	11

CONVERSE NEEDLE HOLDER

Catalog Number	Jaw	Length (in.)
BM200R	LONG SERR	5 1/8

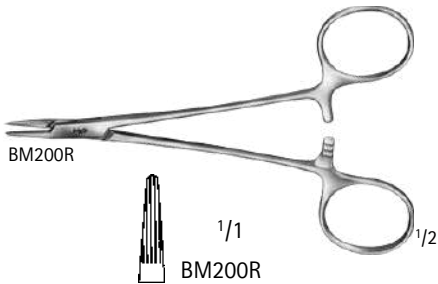

HALSEY NEEDLE HOLDER

Catalog Number	Tip	Jaw	Length (in.)
BM201R	DEL	SMOOTH	5 1/8
BM205R	DEL	X-SERR	5 1/8

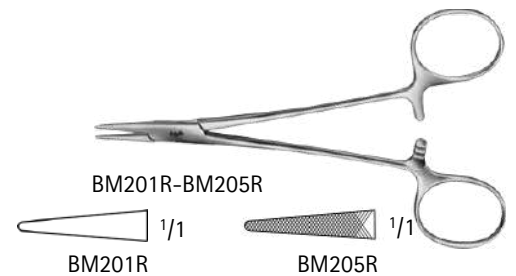

WEBSTER NEEDLE HOLDER

Catalog Number	Jaw	Length (in.)
BM202R	SMOOTH	5

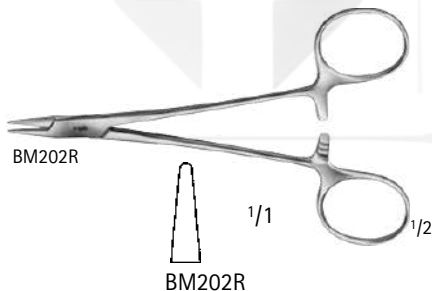

DERF NEEDLE HOLDER

Catalog Number	Jaw	Length (in.)
BM204R	SERR	5



DOYEN NEEDLE HOLDER

Catalog Number	Jaw	Length (in.)
BM210R	X-SERR	5

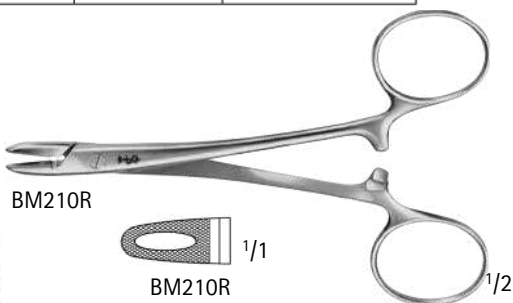

COLLIER NEEDLE HOLDER, FENESTRATED

Catalog Number	Jaw	Length (in.)
MG366R	SERR	5

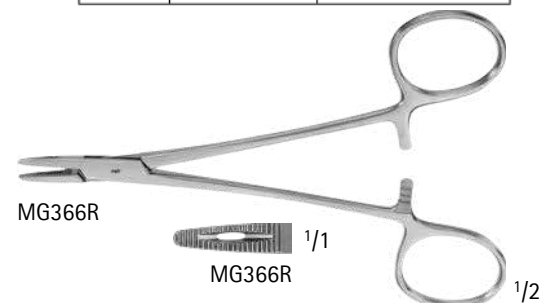

BAUMGARTNER NEEDLE

HOLDER

Catalog Number	Jaw	Length (in.)
MG072R	SERR, GROOVED	5 1/4
BM215R	X-SERR	5 3/4

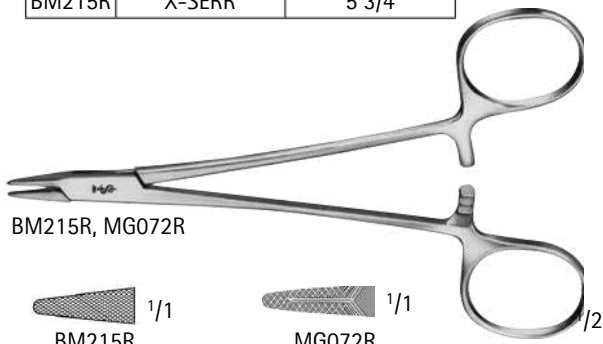

BM215R, MG072R



BM215R



MG072R

CRILE-WOOD

NEEDLE HOLDER

Catalog Number	Jaw	Length (in.)
BM218R	X-SERR	6
BM220R	X-SERR	6 1/4

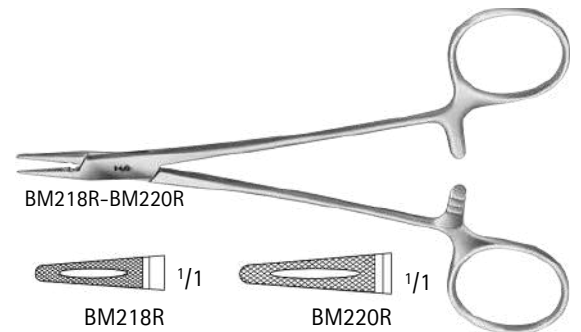

BM218R-BM220R

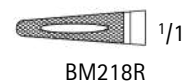

BM218R



BM220R

CRILE-MURRAY NEEDLE

HOLDER

Catalog Number	Jaw	Length (in.)
BM219R	SERR	6

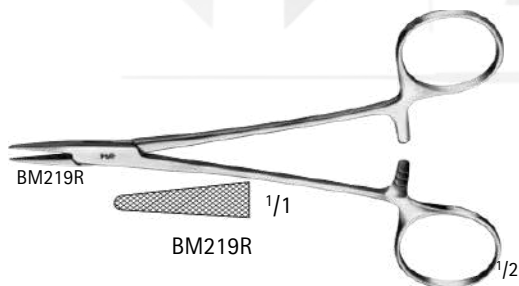

BM219R



BM219R

ADSON NEEDLE

HOLDER,

FENESTRATED

Catalog Number	Jaw	Length (in.)
BM224R	SERR	7

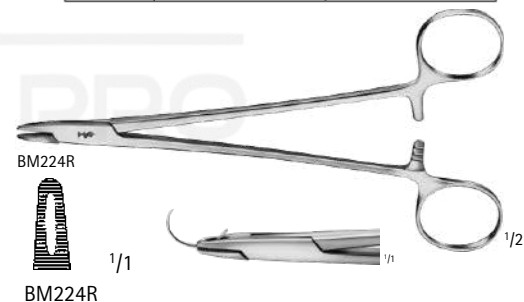

BM224R



BM224R

MAYO-HEGAR NEEDLE

HOLDER

Catalog Number	Jaw	Length (in.)
BM235R	X-SERR	6
BM236R	X-SERR	7 1/4
BM237R	X-SERR	7 7/8

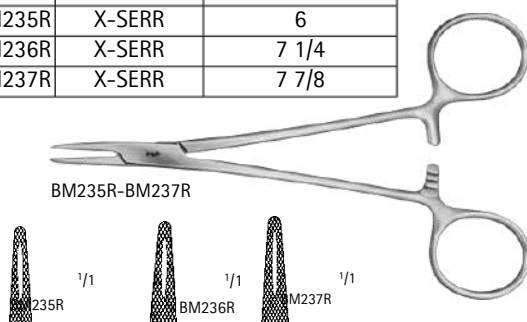

BM235R-BM237R

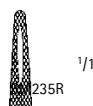

BM235R



BM236R



BM237R

HEGAR NEEDLE HOLDER

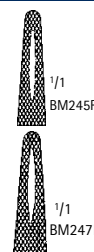

BM245R



BM247R



BM249R

Catalog Number	Tip	Jaw	Length (in.)
BM245R	HEAVY	X-SERR	6
BM247R	HEAVY	X-SERR	6 7/8
BM249R	HEAVY	X-SERR	8
BM255R	HEAVY	X-SERR	8

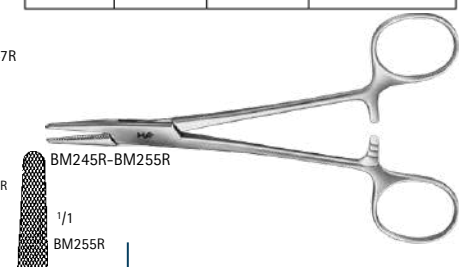

BM245R-BM255R

BM255R

GENERAL SURGERY

Needle Holders

HEANEY NEEDLE HOLDER

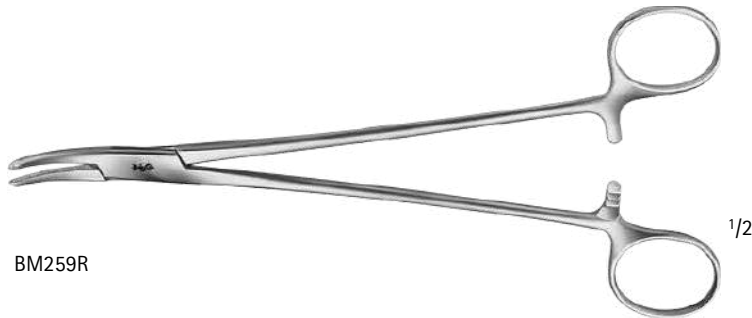

Catalog Number	Tip	Jaw	Length (in.)
BM259R	CVD	SERR	7 7/8

JAMESON NEEDLE HOLDER

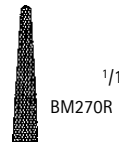
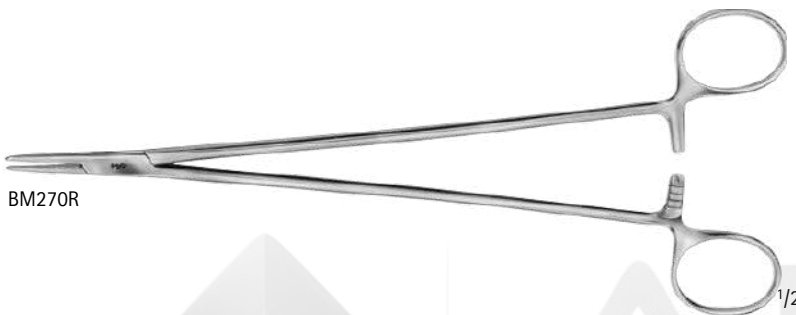

Catalog Number	Tip	Jaw	Length (in.)
BM270R	DEL	X-SERR	9

WANGENSTEEN NEEDLE HOLDER

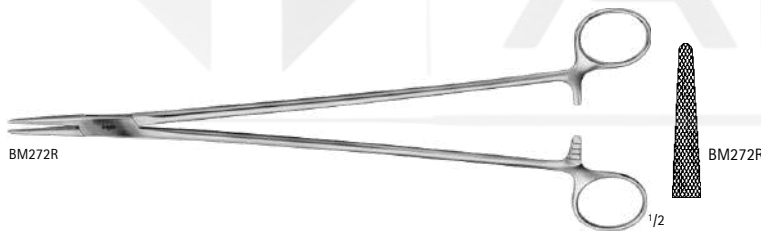

Catalog Number	Jaw	Length (in.)
BM272R	X-SERR	10 3/4

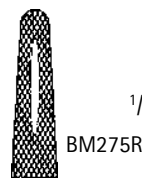
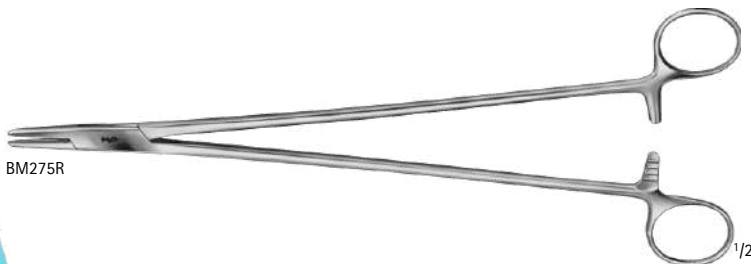

Catalog Number	Jaw	Length (in.)
BM275R	X-SERR	10 1/2

HEGAR-OLSEN NEEDLE HOLDER/SCISSORS

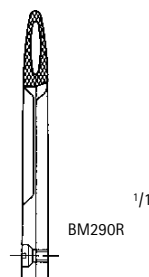
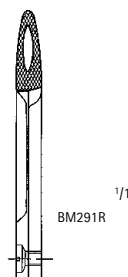
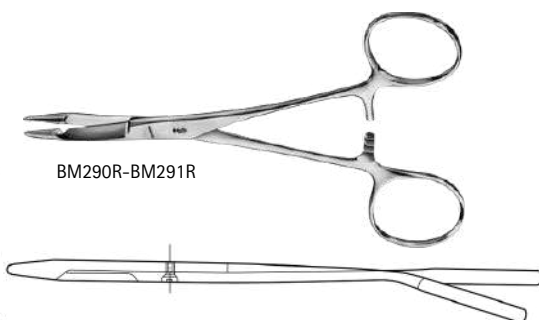

Catalog Number	Jaw	Length (in.)
BM290R	SERR	5 1/2
BM291R	SERR	7 1/4

GENERAL SURGERY

Needle Holders

GILLIES NEEDLE HOLDER/SCISSORS

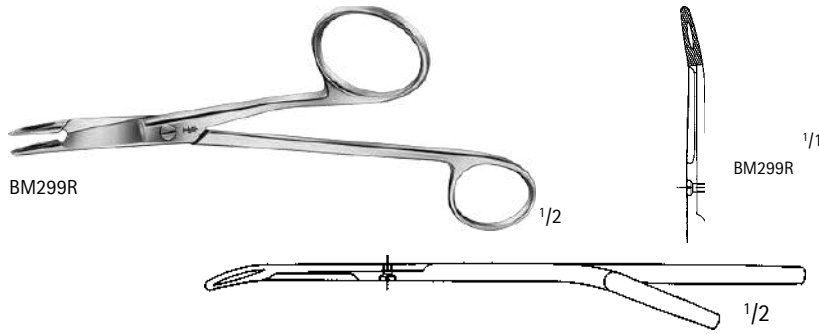

Catalog Number	Jaw	Length (in.)
BM299R	SERR	6 1/4

GENERAL SURGERY

Alis Pro™ TC Needle Holders

Aesculap features Needle Holders with Tungsten Carbide (TC) inserts. A smooth jaw and three different serration patterns are available, depending on the size of the suture needle.

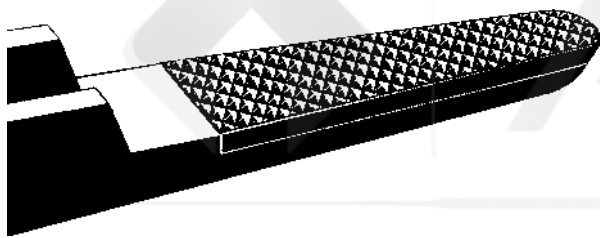
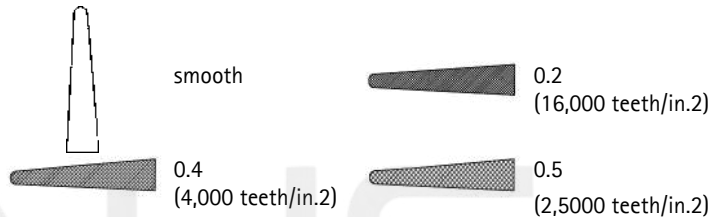

We recommend carbide inserts as follows:

Jaw Surface Smooth 0.2 mm pitch of serration 0.4 mm pitch of serration 0.5 mm pitch of serration

Suture Material
9/0 - 11/0
6/0 - 10/0
4/0 - 6/0
up to 3/0

ALIS PRO TC HELLBERG-KUPKA NEEDLE HOLDER W/ ERGONOMIC HANDLE



Catalog Number	Jaw	Length (in.)
BM320R	SERR	8 1/4

ALIS PRO TC DERF NEEDLE HOLDER

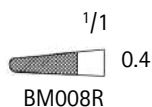

Catalog Number	Jaw	Length (in.)
BM008R	SERR	4 3/4

ALIS PRO TC MASING NEEDLE HOLDER

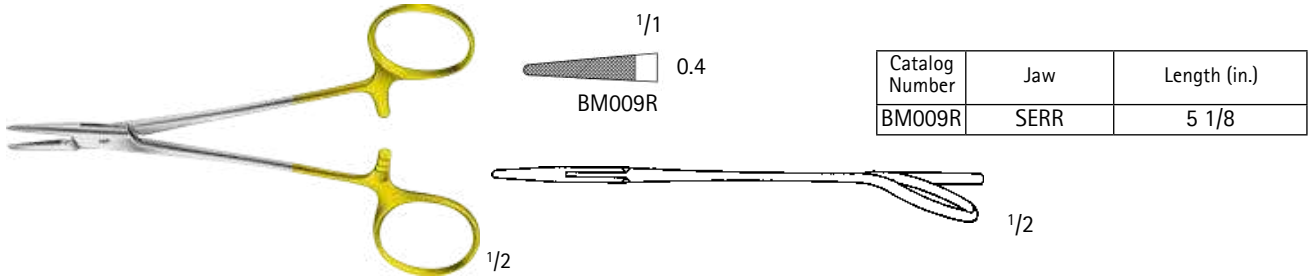

ALIS PRO TC HALSEY NEEDLE HOLDER

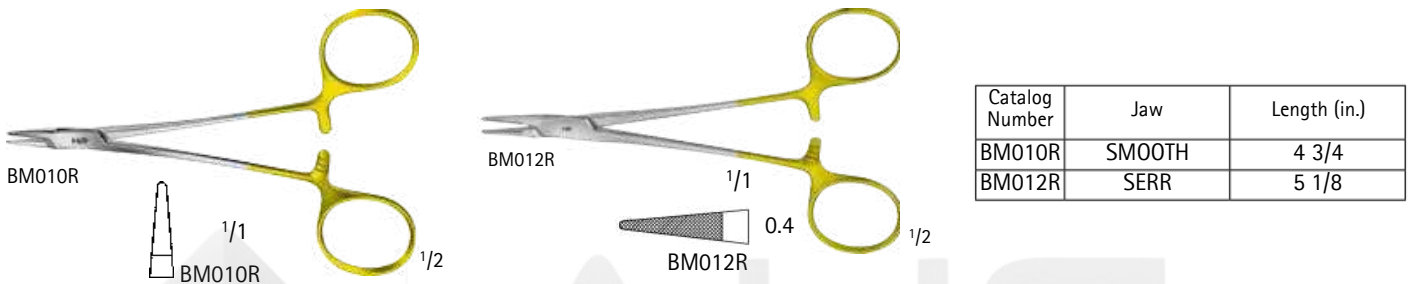

ALIS PRO TC CONVERSE NEEDLE HOLDER

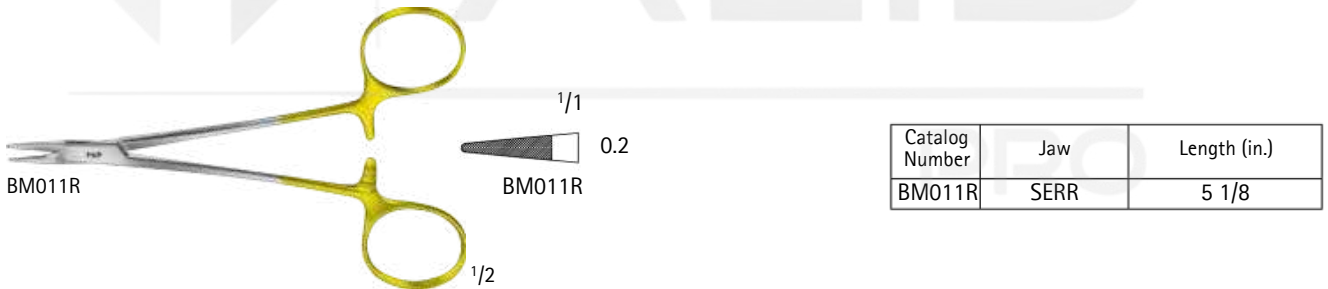

ALIS PRO TC WEBSTER NEEDLE HOLDER

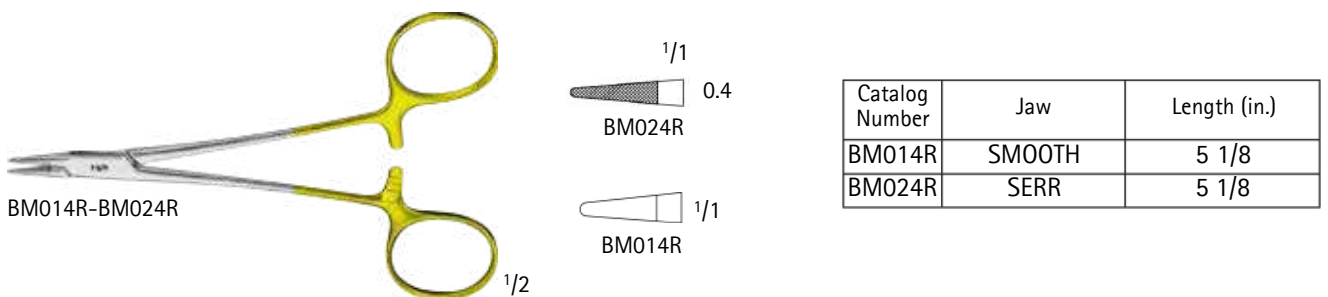

Alis Pro™ TC Needle Holders

ALIS PRO TC BAUMGARTNER NEEDLE HOLDER

Catalog Number	Jaw	Length (in.)
BM015R	SERR	5 3/4

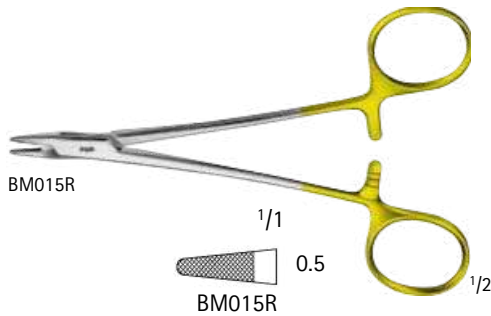

ALIS PRO TC NEW ORLEANS NEEDLE HOLDER

Catalog Number	Jaw	Length (in.)
MG522R	SERR	7

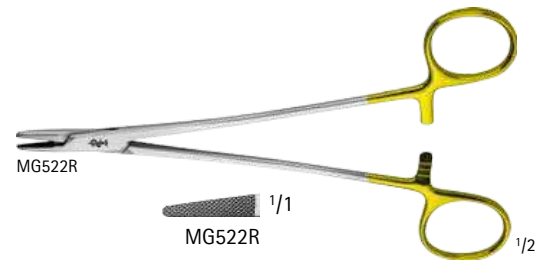

ALIS PRO TC SAROT NEEDLE HOLDER

Catalog Number	Jaw	Length (in.)
BM020R	SERR	7
BM023R	SERR	10 1/4

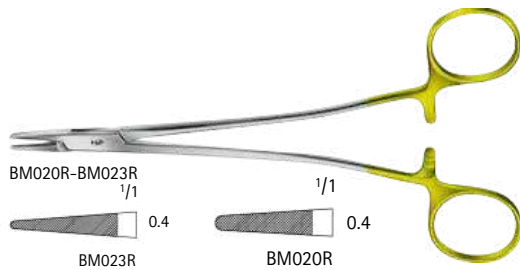

ALIS PRO TC BABY CRILE-WOOD NEEDLE HOLDER

Catalog Number	Jaw	Length (in.)
BM013R	SERR	6



ALIS PRO TC MAYO-HEGAR-SEELEY NEEDLE HOLDER

Catalog Number	Jaw	Length (in.)
BM022R	SERR	8

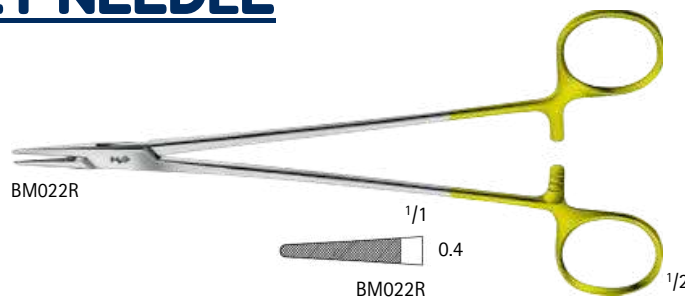

ALIS PRO TC CRILE-WOOD NEEDLE HOLDER

Catalog Number	Jaw	Length (in.)
BM016R	SERR	5 3/4
BM017R	SERR	7 1/4
BM019R	SERR	7 7/8
BM030R	SERR	10 5/8
BM021R	SERR	12
MB604R	SERR	14
BM029R	SMOOTH	6

ALIS PRO TC FINE NEEDLE HOLDER

Catalog Number	Tip	Jaw	Length (in.)
BM025R	X-DEL	SERR	7
BM026R	X-DEL	SERR	7 7/8
BM027R	X-DEL	SERR	9

ALIS PRO TC DEBAKEY NEEDLE HOLDER

Catalog Number	Tip	Jaw	Length (in.)
BM032R	DEL	SERR	6
BM033R	DEL	SERR	6 1/2
BM035R	DEL	SERR	7
BM034R	DEL	SERR	8 1/4
BM036R	DEL	SERR	9
BM037R	DEL	SERR	10 1/4
BM038R	DEL	SERR	12
BM063R	X-DEL	SERR	6 1/2
BM064R	X-DEL	SERR	8 1/4
BM040R	X-DEL	SERR	12

ALIS PRO TC RYDER NEEDLE HOLDER

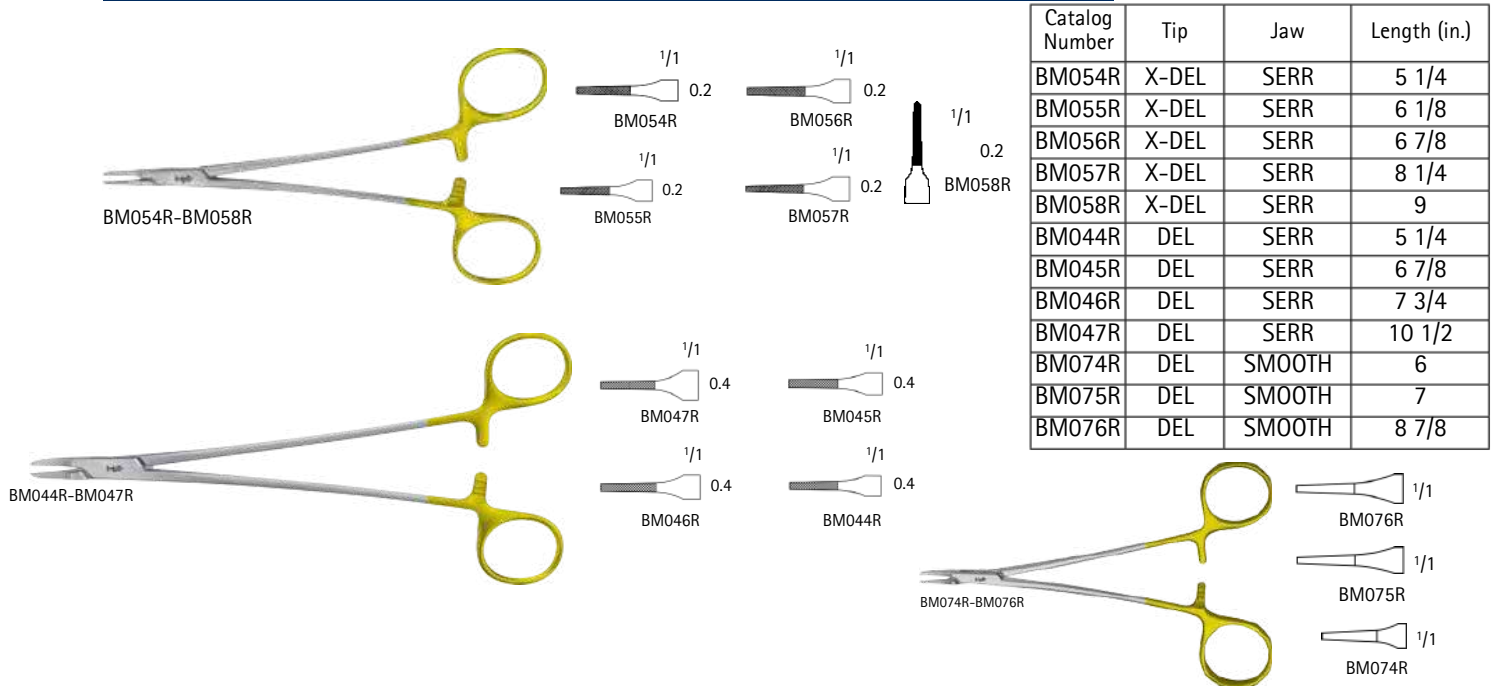

Catalog Number	Tip	Jaw	Length (in.)
BM054R	X-DEL	SERR	5 1/4
BM055R	X-DEL	SERR	6 1/8
BM056R	X-DEL	SERR	6 7/8
BM057R	X-DEL	SERR	8 1/4
BM058R	X-DEL	SERR	9
BM044R	DEL	SERR	5 1/4
BM045R	DEL	SERR	6 7/8
BM046R	DEL	SERR	7 3/4
BM047R	DEL	SERR	10 1/2
BM074R	DEL	SMOOTH	6
BM075R	DEL	SMOOTH	7
BM076R	DEL	SMOOTH	8 7/8

ALIS PRO TC FRENCH EYE NEEDLE HOLDER

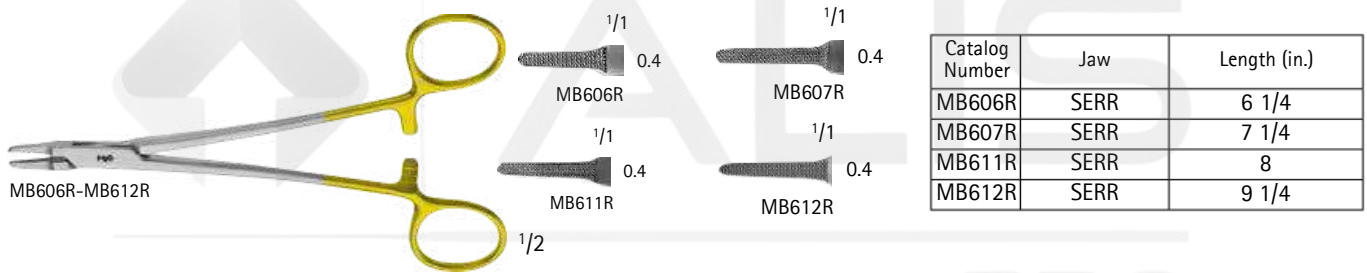

Catalog Number	Jaw	Length (in.)
MB606R	SERR	6 1/4
MB607R	SERR	7 1/4
MB611R	SERR	8
MB612R	SERR	9 1/4

ALIS PRO TC MAYO-HEGAR NEEDLE HOLDER

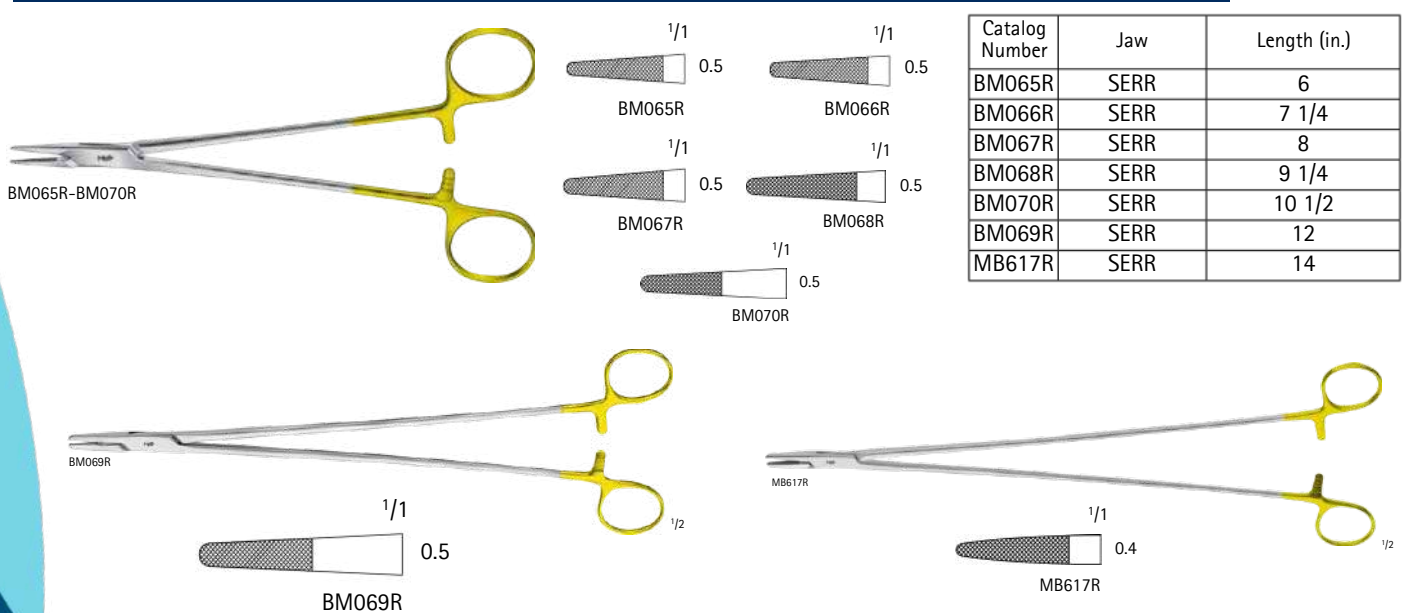

Catalog Number	Jaw	Length (in.)
BM065R	SERR	6
BM066R	SERR	7 1/4
BM067R	SERR	8
BM068R	SERR	9 1/4
BM070R	SERR	10 1/2
BM069R	SERR	12
MB617R	SERR	14

GENERAL SURGERY

Alis Pro™ TC Needle Holders



ALIS PRO TC HEGAR NEEDLE HOLDER

Catalog Number	Tip	Jaw	Length (in.)
BM077R	HEAVY	SERR	8
BM078R	HEAVY	SERR	9 1/2

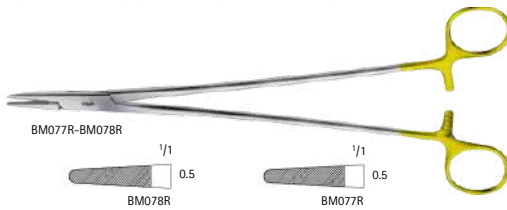

ALIS PRO TC WANGENSTEEN NEEDLE HOLDER

Catalog Number	Jaw	Length (in.)
BM042R	SERR	10 3/4

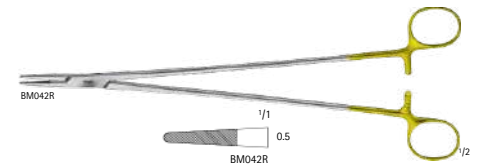

ALIS PRO TC MASSON NEEDLE HOLDER

Catalog Number	Jaw	Length (in.)
BM090R	SERR	10 1/2

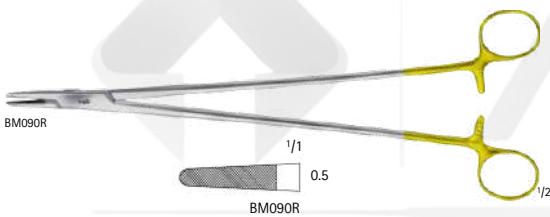

ALIS PRO TC MAYO- MASSON NEEDLE HOLDER

Catalog Number	Jaw	Length (in.)
MB918R	SERR	16



ALIS PRO TC HEANEY NEEDLE HOLDER

Catalog Number	Tip	Jaw	Length (in.)
BM081R	CVD	SERR	7 7/8
BM084R	CVD	SERR	10 1/4

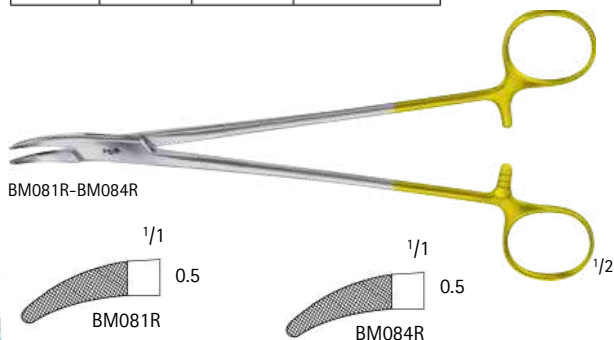

ALIS PRO TC MUELLER NEEDLE HOLDER

Catalog Number	Tip	Jaw	Length (in.)
BM089R	CVD	SERR	14 1/4

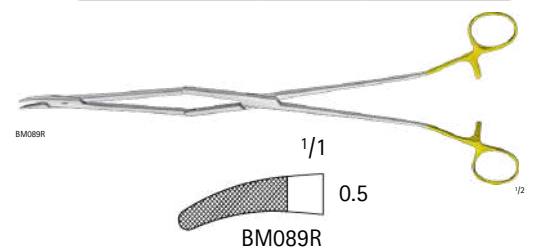

GENERAL SURGERY

Alis Pro™ TC Needle Holders



ALIS PRO TC FINOCHIETTO NEEDLE HOLDER

Catalog Number	Tip	Jaw	Length (in.)
BM092R	ANG	SERR	10 1/2

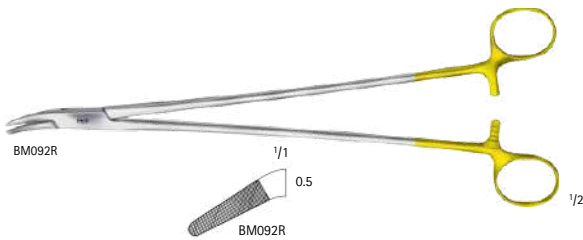

ALIS PRO TC STRATTE NEEDLE HOLDER

Catalog Number	Tip	Jaw	Length (in.)
BM095R	CVD	SERR	8 1/4
BM096R	CVD	SERR	9

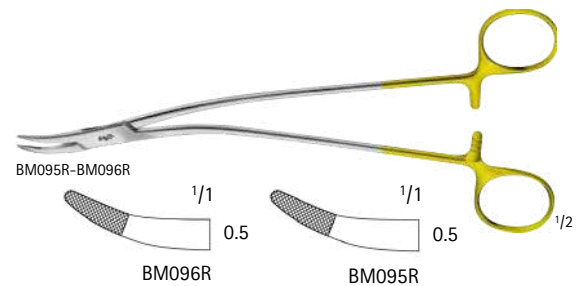

ALIS PRO TC WIRE TWISTER

Catalog Number	Tip	Jaw	Length (in.)
BM110R	ROUND	SERR	6 1/8
BM111R	SQUARE	SERR	6

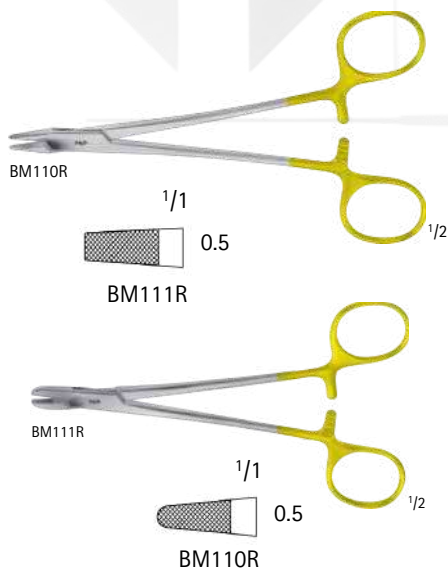

ALIS PRO TC BAUMGARTNER WIRE TWISTER

Catalog Number	Tip	Jaw	Length (in.)
BM112R	SQUARE	SERR	7 7/8

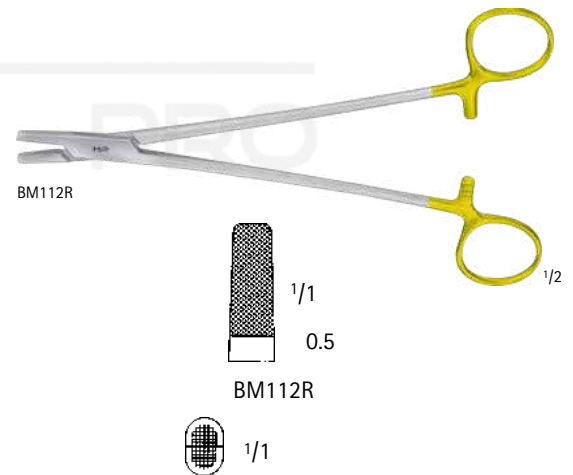

ALIS PRO TC BERRY STERNAL WIRE TWISTER



Catalog Number	Tip	Jaw	Length (in.)
MD456R	ROUND	SERR	7 1/4

ALIS PRO TC RUBIO WIRE TWISTER



Catalog Number	Tip	Jaw	Length (in.)
MB550R	ROUND	SERR	5

ALIS PRO TC MATHIEU NEEDLE HOLDER

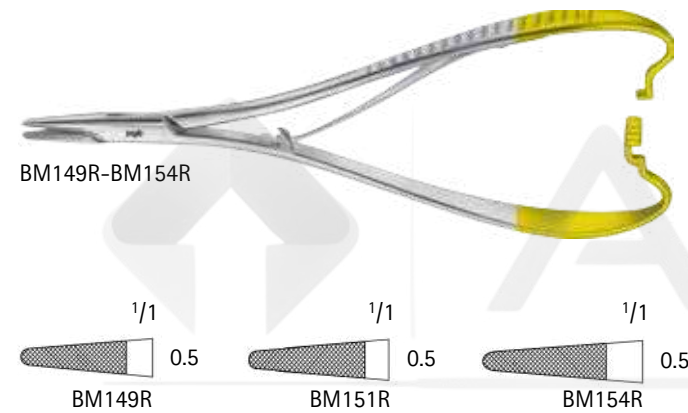

Catalog Number	Jaw	Length (in.)
BM149R	SERR	5 1/2
BM151R	SERR	6 1/2
BM154R	SERR	7 7/8

ALIS PRO TC MATHIEU NEEDLE HOLDER, HEAVY

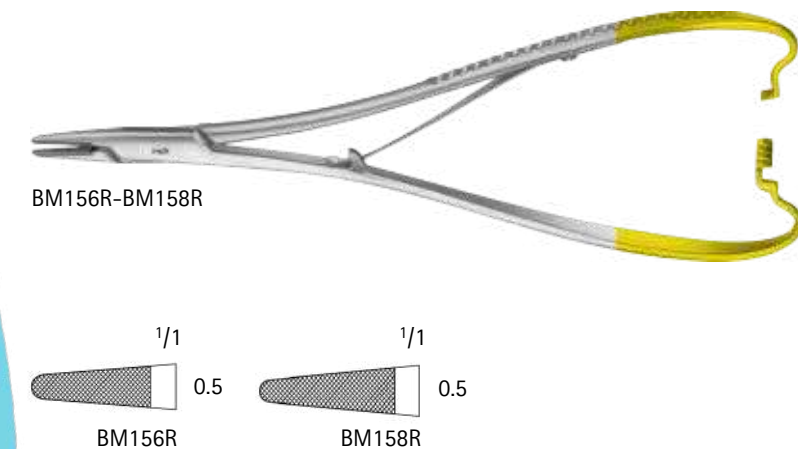

Catalog Number	Jaw	Length (in.)
BM156R	SERR	7 7/8
BM158R	SERR	9 5/8

Needle Cases

NEEDLE CASE, RECTANGLE

Catalog Number	Dimensions (mm)
BL907R	70 x 53 x 9



BL907R

NEEDLE CASE, ROUND

BL930R-BL933R

Catalog Number	Item	Dimensions (mm)
BL930R	COMPLETE NEEDLE CASE W/ INTERIOR BOX	65 x 16
BL931R	INTERIOR BOX ONLY	62 x 12
BL933R	INTERIOR BOX ONLY	90 x 12



BL931R-
BL933R



BL941R

NEEDLE CASE, WITH 7 SECTIONS

Catalog Number	Dimensions (mm)
BL941R	150 x 90 x 10

GENERAL SURGERY

Ligature Needles

DESCHAMPS NEEDLE



BM822R-BM824R

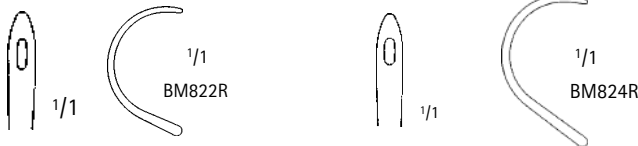

BM749R, BM781R, BM807R, BM809R,
BM811R, BM813R

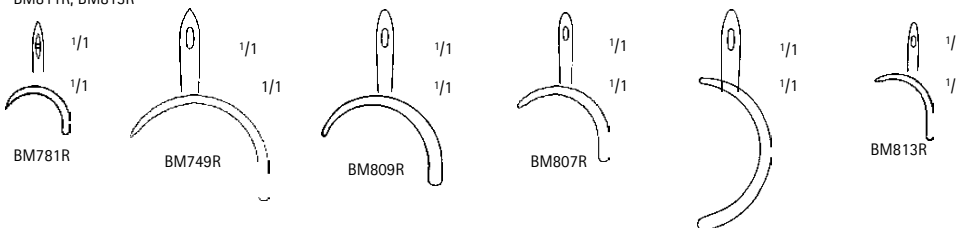

Catalog Number	Hand Orientation	Tip	Length (in.)
BM822R	RIGHT	BLUNT, 3.5 MM	9 1/2
BM824R	RIGHT	BLUNT, 5 MM	11
BM781R	LEFT	SHARP, 2 MM	8 1/4
BM749R	LEFT	SHARP, 3.5 MM	8 1/2
BM809R	LEFT	BLUNT, 2.5 MM	8 1/4
BM807R	LEFT	BLUNT, 2.5 MM	8 1/2
BM811R	LEFT	BLUNT, 3.5 MM	8 1/2
BM813R	LEFT	STEEP, BLUNT, 2 MM	8 7/8

GENERAL SURGERY

Needle Cases

HURD NEEDLE



Catalog Number	Hand Orientation	Tip	Length (in.)
BM770R	RIGHT	SHARP	8 1/4
BM771R	LEFT	SHARP	8 1/4

KRONECKER NEEDLE



Catalog Number	Hand Orientation	Tip	Length (in.)
BM801R	RIGHT	BLUNT	6 1/8
BM802R	LEFT	BLUNT	6 1/8

SYME SUTURE NEEDLE



Catalog Number	Tip	Length (in.)
BM855R	BLUNT	6 3/4

GENERAL SURGERY

Dressing and Tissue Forceps

MONOPOLAR DIATHERMI FORCEPS, INSULATED

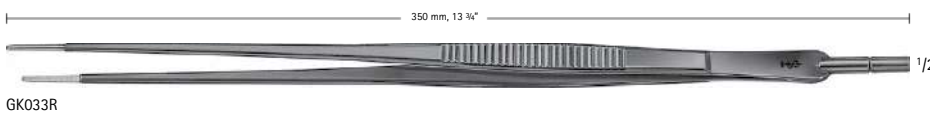

Catalog Number	Length (in.)
GK033R	13 3/4

DRESSING FORCEPS, STANDARD PATTERNS

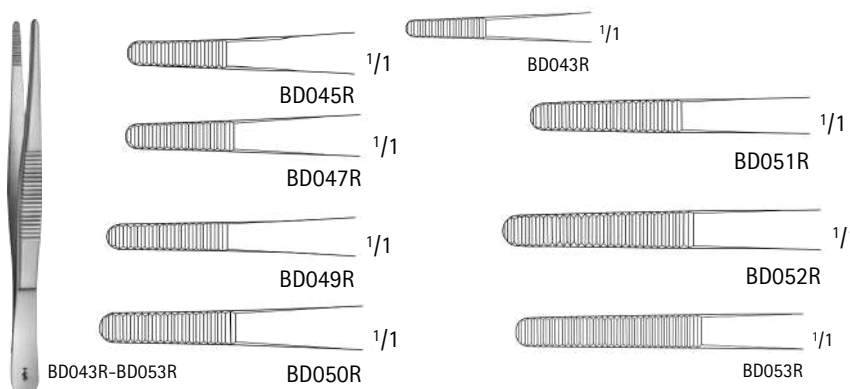

Catalog Number	Tip	Length (in.)
BD043R	SERR	4 1/2
BD045R	SERR	5 1/8
BD047R	SERR	5 3/4
BD049R	SERR	6 1/4
BD050R	SERR	7
BD051R	SERR	7 7/8
BD052R	SERR	9 3/4
BD053R	SERR	11 3/4

Dressing and Tissue Forceps

DRESSING FORCEPS, EXTRA WIDE

Catalog Number	Tip	Length (in.)
BD077R	SERR	5 3/4

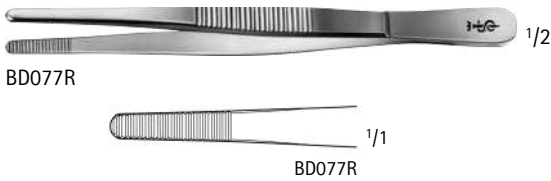

TISSUE FORCEPS, MEDIUM

Catalog Number	Teeth	Length (in.)
BD547R	1 x 2	5 3/4
BD549R	1 x 2	6 1/4

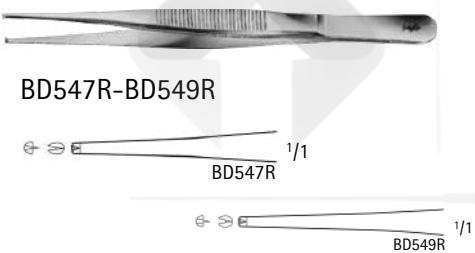

CURTIS TISSUE FORCEPS

Catalog Number	Tip	Length (in.)
MG077R	SERR	8 3/4

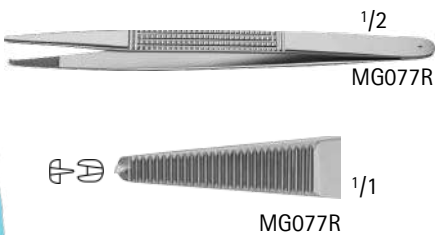

DRESSING FORCEPS, EXTRA WIDE

Dressing Forceps, Delicate

Catalog Number	Tip	Length (in.)
BD023R	STR, SERR	4 1/2
BD025R	STR, SERR	5 1/8
BD027R	STR, SERR	5 3/4
BD029R	STR, SERR	6 1/4
BD033R	STR, SERR	12
BD035R	CVD, SERR	5 1/8
BD037R	CVD, SERR	5 1/2

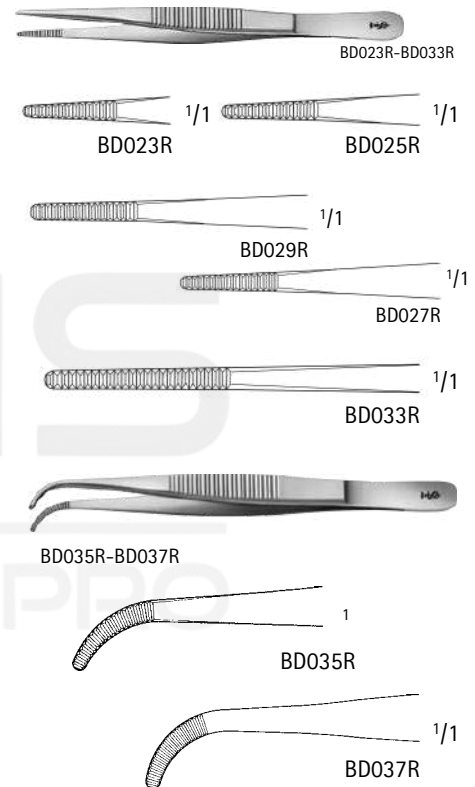

DRESSING FORCEPS, EXTRA DELICATE

Catalog Number	Tip	Length (in.)
BD210R	SERR	4 1/2

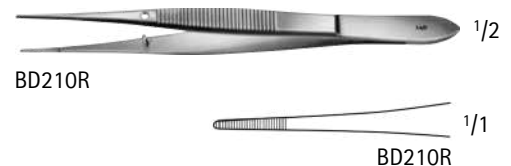

Dressing and Tissue Forceps

TISSUE FORCEPS, DELICATE

Catalog Number	Tip	Teeth	Length (in.)
BD533R	STR	1 x 2	4 1/2
BD535R	STR	1 x 2	5 1/8
BD537R	STR	1 x 2	5 3/4
BD539R	STR	1 x 2	6 1/4
BD540R	STR	1 x 2	7
BD541R	STR	1 x 2	7 7/8
BD542R	STR	1 x 2	9 3/4
BD543R	STR	1 x 2	11 3/4
MB803R	STR	2 x 3	4 1/2
BD575R	STR	2 x 3	5 1/8
BD577R	STR	2 x 3	5 3/4
BD579R	STR	2 x 3	6 1/4
BD580R	STR	2 x 3	7
BD581R	STR	2 x 3	7 7/8
BD587R	STR	3 x 4	5 3/4
BD589R	STR	3 x 4	6 1/4
BD591R	STR	3 x 4	7 7/8
BD527R	CVD	1 x 2	5 3/4

BD533R-BD543R

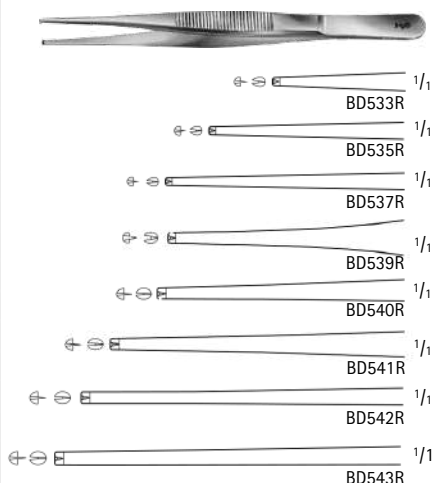

BD575R-BD581R

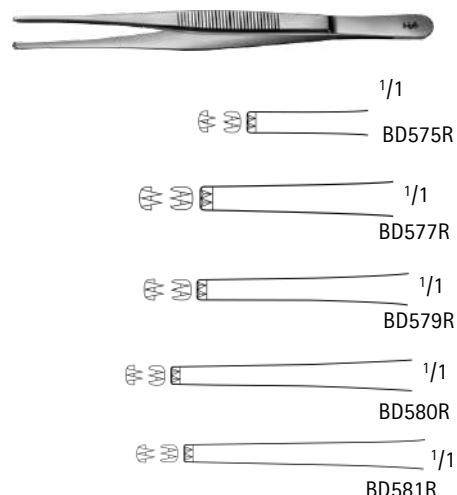

BD587R-BD591R

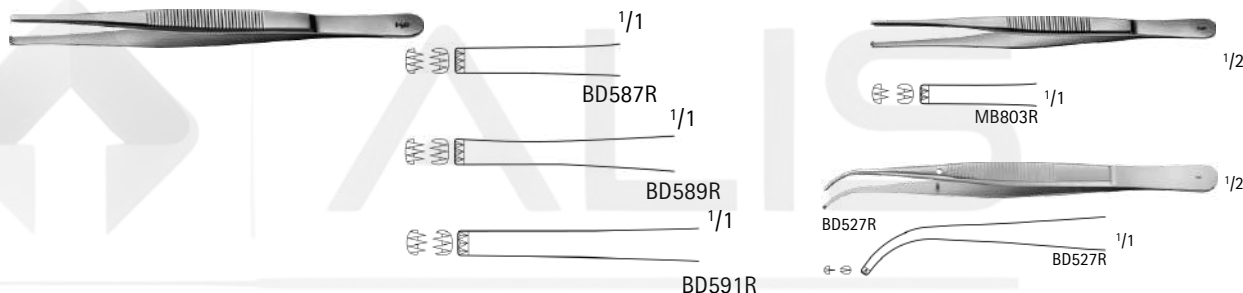

TISSUE FORCEPS, DELICATE

Tissue Forceps, Standard Patterns

Catalog Number	Teeth	Length (in.)
BD553R	1 x 2	4 1/2
BD555R	1 x 2	5 1/8
BD557R	1 x 2	5 3/4
BD559R	1 x 2	6 1/4
BD560R	1 x 2	7
BD561R	1 x 2	7 7/8
BD562R	1 x 2	9 3/4
BD563R	1 x 2	11 3/4

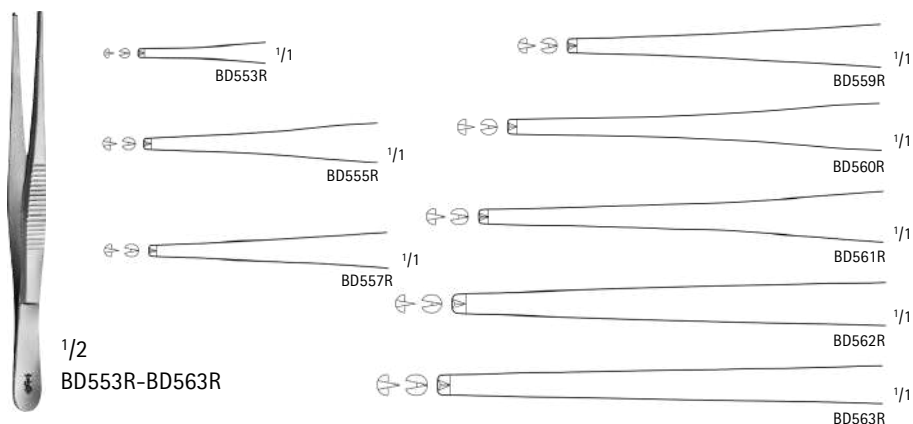

GENERAL SURGERY

Dressing and Tissue Forceps

STRASSBURGER TISSUE FORCEPS

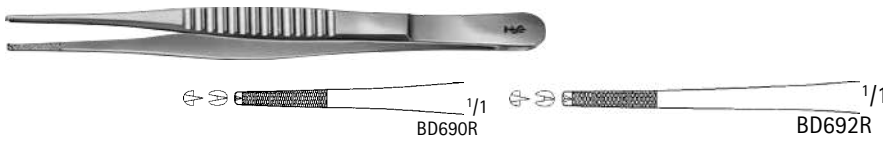

Catalog Number	Tip	Teeth	Length (in.)
BD690R	X-SERR	1 x 2	6
BD692R	X-SERR	1 x 2	7 7/8

BONNEY TISSUE FORCEPS

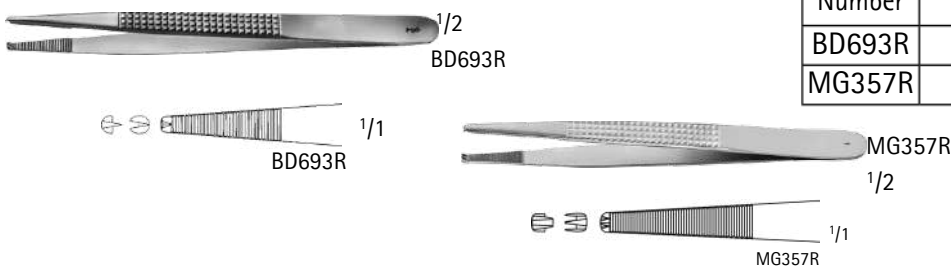

Catalog Number	Tip	Teeth	Length (in.)
BD693R	SERR	1 x 2	6 7/8
MG357R	SERR	2 x 3	6 3/4

MARTIN TISSUE FORCEPS



Catalog Number	Teeth	Length (in.)
BD733R	7 x 8	6 1/8

HEANEY TISSUE FORCEPS

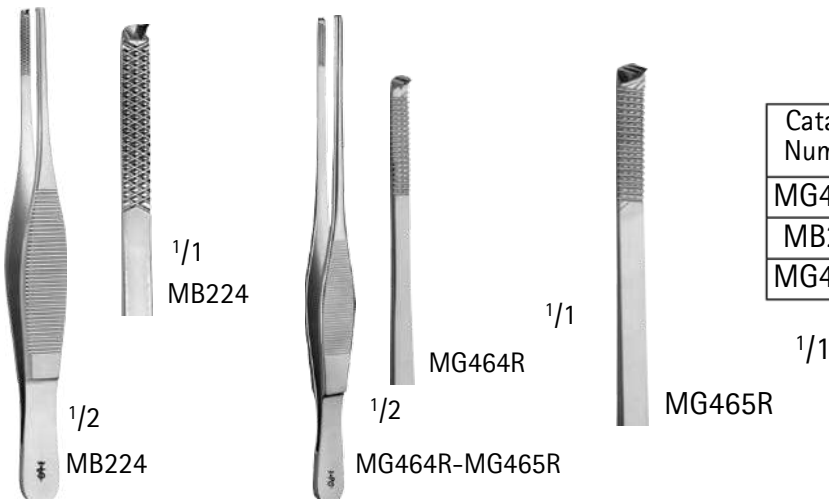

Catalog Number	Tip	Teeth	Length (in.)
MG464R	X-SERR	1 x 2	7 1/4
MB224	X-SERR	2 x 3	5 1/2
MG465R	X-SERR	3 x 4	7 1/2

GENERAL SURGERY

Dressing and Tissue Forceps

STILLE-BARRAYA CV FORCEPS

BD725R-BD727R

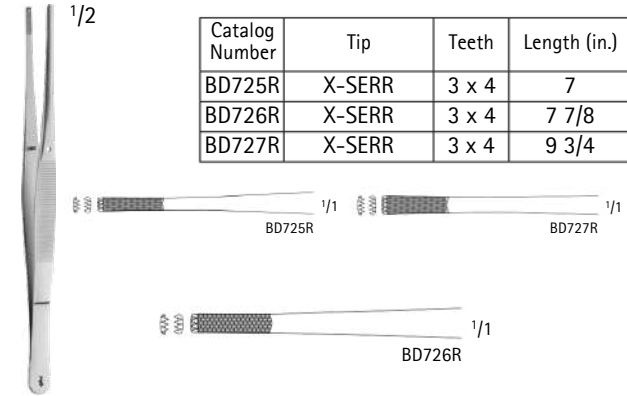

RUSSIAN TISSUE FORCEPS

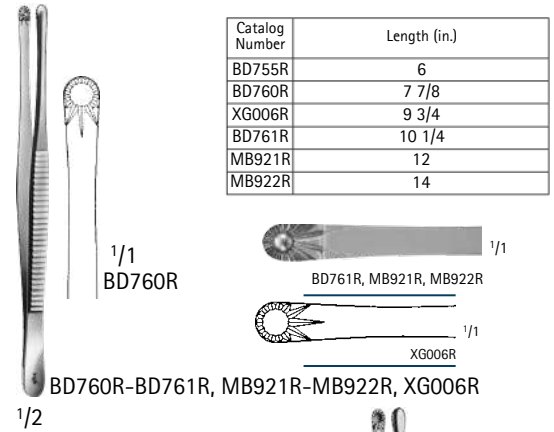

MAYO-RUSSIAN TISSUE FORCEPS

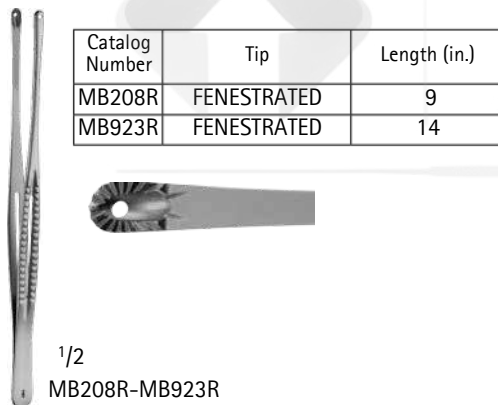

SELMAN TISSUE FORCEPS

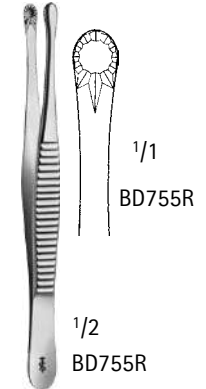
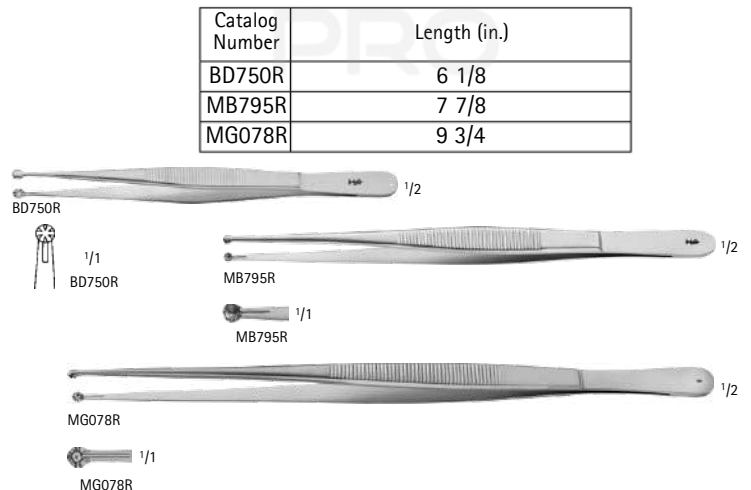

GENERAL SURGERY

Dressing and Tissue Forceps

LUCAE BAYONET FORCEPS

Catalog Number	Tip	Teeth	Length (in.)
BD878R	SERR	-	5 1/2
BD879R	SMOOTH	1 x 2	5 1/2

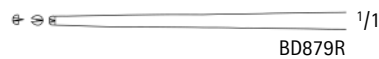

CUSHING BAYONET FORCEPS

Catalog Number	Tip	Teeth	Length (in.)
US147	SERR	-	7 3/4
MB231	SMOOTH	1 x 2	7 1/4

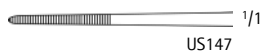

JANSEN BAYONET FORCEPS

Catalog Number	Tip	Length (in.)
BD880R	SERR	6 1/4
MB236	SERR	6 1/2



GRUENWALD BAYONET FORCEPS

Catalog Number	Tip	Length (in.)
BD883R	SERR	7 7/8



BROWN-CUSHING BAYONET FORCEPS

Catalog Number	Teeth	Length (in.)
MB227	7 x 7	7 1/4



BROWN-BAHNSON BAYONET FORCEPS

Catalog Number	Tip	Length (in.)
BD876R	SERR	6 1/8
MB804R	SERR	8



GENERAL SURGERY

Dressing and Tissue Forceps

BAYONET FORCEPS

Catalog Number	Tip	Teeth	Length (in.)
BD885R	SMOOTH	-	7 1/4
BD886R	SMOOTH	1 x 2	7 7/8



BAYONET FORCEPS

Catalog Number	Tip	Length (in.)
BD887R		6 1/4
FD110R	FINE	7 1/4
FD111R	BROAD	7 1/4



GERALD BAYONET FORCEPS

Catalog Number	Tip	Teeth	Length (in.)
US105	SERR	-	7 1/2
US104	SMOOTH	1 x 2	7 1/2



TROELTSCH BAYONET FORCEPS

Catalog Number	Tip	Length (in.)
BD900R	ANG/SERR	4
BD902R	ANG/SERR	4 1/2
BD910R	ANG/SERR	5 1/2
BD911R	ANG/SERR	6 3/4

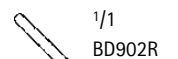
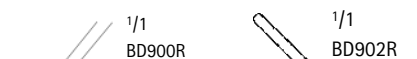

WILDE BAYONET FORCEPS

Catalog Number	Tip	Length (in.)
BD904R	ANG/SERR	4 1/2



BD904R

Dressing and Tissue Forceps

HUDSON FORCEPS

Catalog Number	Tip	Teeth	Length (in.)
BD225R	SERR	-	5
MB291R	SMOOTH	1 x 2	5



BD225R, MB291R

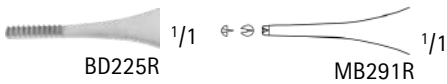

FERRIS-SMITH TISSUE FORCEPS

Catalog Number	Tip	Teeth	Length (in.)
BD610R	X-SERR	1 x 2	6 7/8
BD611R	X-SERR	2 x 3	6 7/8



BD610R-BD611R



SEMKEN FORCEPS, DELICATE

Catalog Number	Tip	Teeth	Length (in.)
BD215R	SERR	-	5
BD216R	SERR	-	6
BD665R	SMOOTH	1 x 2	5
BD667R	SMOOTH	1 x 2	6
BD666R	SMOOTH	2 x 3	5



BD215R-BD216R

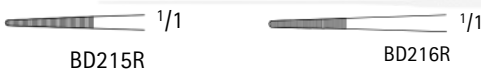

BD215R

BD216R

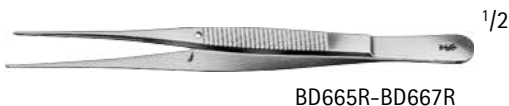

BD665R-BD667R

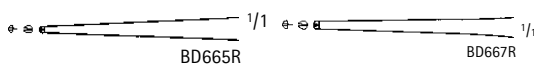

BD665R

BD667R

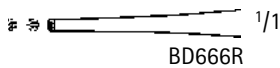

BD666R

MICRO ADSON FORCEPS, DELICATE

Catalog Number	Tip	Length (in.)
BD220R	SERR, W/ PLATFORM	4 3/4
BD223R	SERR	6



BD220R

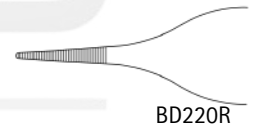

BD220R



BD223R

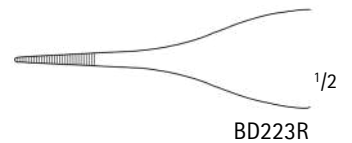

BD223R

ADSON FORCEPS, DELICATE

Catalog Number	Tip	Teeth	Handle	Length (in.)
BD222R	SERR	-	-	4 3/4
MA156R	SERR, X-LONG	-	-	4 3/4
BD511R	SMOOTH	1 x 2	-	4 3/4
MG275R	SERR	1 x 2	-	4 3/4
BD512RX	SERR W/ PLATFORM	1 x 2	-	4 3/4
MA536R	X-LONG	1 x 2	FENE-	4 3/4
MB454R	SMOOTH	2 x 3	STRATED	4 3/4
BD506R	SMOOTH	1 x 2	FENE-	4 3/4
BD507R	SMOOTH	1 x 2	FENE-	4 3/4
BD508R	SERR	1 x 2	STRATED FENE-	4 3/4
BD513RX	SERR W/ PLATFORM	1 x 2	STRATED	4 3/4
BD521R	SMOOTH	1 x 2	FENE- STRATED	6

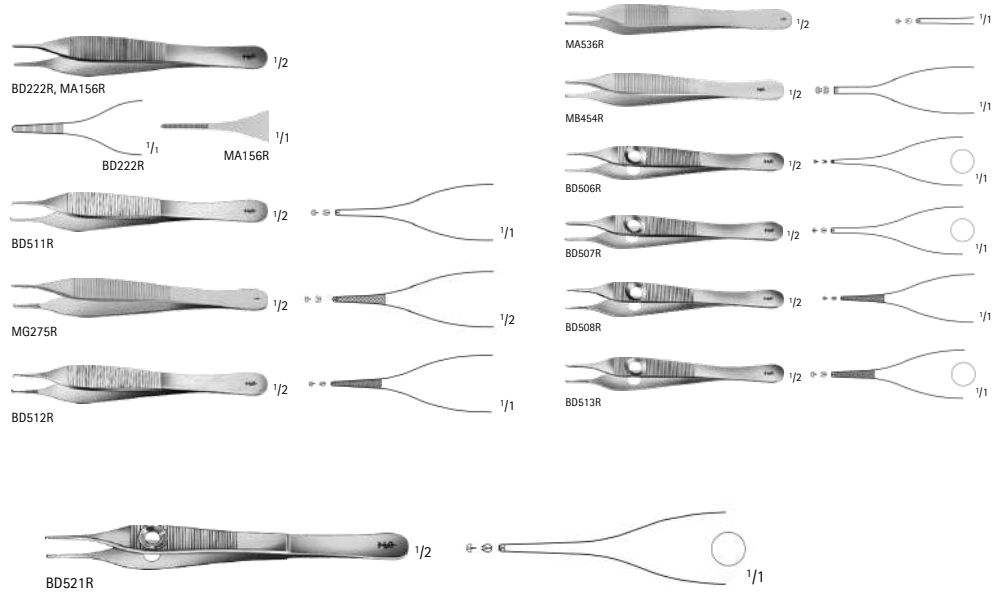

MUSTARDE SUTURE REMOVAL FORCEPS

Catalog Number	Tip	Length (in.)
MG358R	LONGITUDINAL, SERR	5

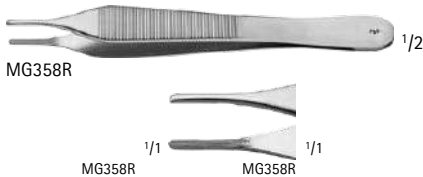

MICRO ADSON TISSUE FORCEPS, DELICATE

Catalog Number	Teeth	Length (in.)
BD510R	1 x 2	4 3/4
BD520R	1 x 2	6

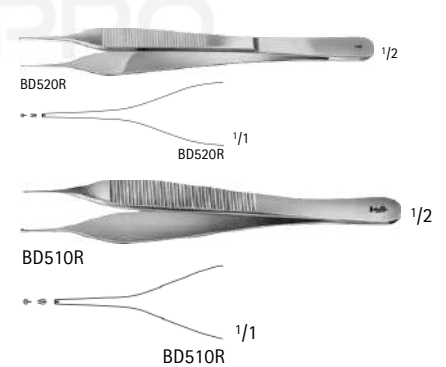

GERALD TISSUE FORCEPS, DELICATE

Catalog Number	Tip	Teeth	Length (in.)
BD662R	STR	1 x 2	6 7/8
BD664R	STR	1 x 2	9
BD663R	CVD	1 x 2	6 7/8



GENERAL SURGERY

Dressing and Tissue Forceps

CALLISON-ADSON TISSUE FORCEPS, W/ PLATFORM

Catalog Number	Teeth	Length (in.)
MA537R	1 x 2	5

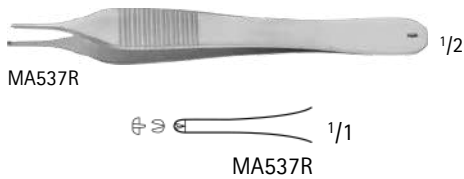

GERALD-DEBAKEY FORCEPS, NARROW

Catalog Number	Tip	Length (in.)
MG422R	SERR	9

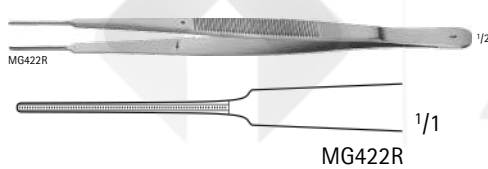

BROWN TISSUE FORCEPS

Catalog Number	Teeth	Length (in.)
BD701R	7 x 8	6
BD702R	7 x 8	7 7/8

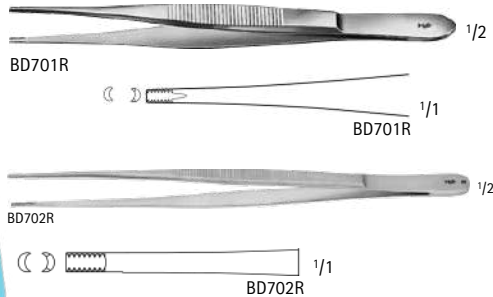

ADSON-BROWN TISSUE FORCEPS

Catalog Number	Teeth	Length (in.)
BD700R	7 x 8	4 3/4

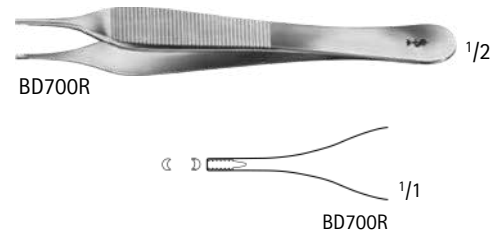

ADSON TISSUE FORCEPS, DELICATE

Catalog Number	Teeth	Length (in.)
BD522R	1 x 2	7

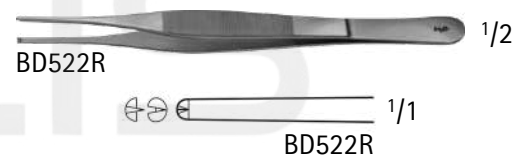

GERALD DRESSING FORCEPS, DELICATE

Catalog Number	Tip	Length (in.)
BD228R	STR, SERR	6 7/8
BD230R	STR, SERR	9
BD229R	CVD, SERR	6 7/8

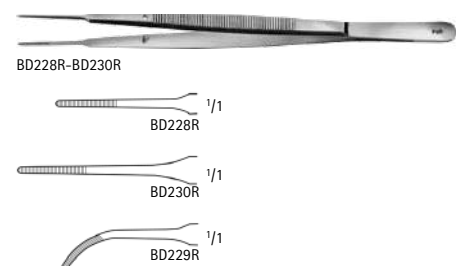

Dressing and Tissue Forceps

JEFFERSON TISSUE FORCEPS, DELICATE

Catalog Number	Teeth	Length (in.)
BD523R	1 x 2	7

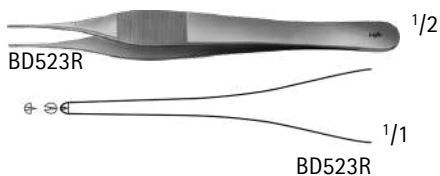

MCINDOE THUMB FORCEPS, DELICATE

Catalog Number	Tip	Length (in.)
BD236R	SERR	6



MCINDOE TISSUE FORCEPS, DELICATE

Catalog Number	Tip	Teeth	Length (in.)
BD661R	SERR	1 x 2	6

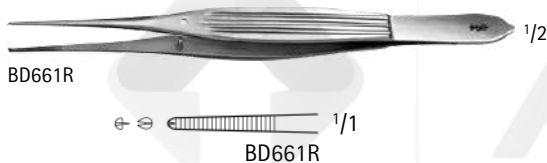

DELICATE FORCEPS, ANGLED

Catalog Number	Tip	Length (in.)
BD257R	SERR	7 7/8



CUSHING TISSUE FORCEPS

Catalog Number	Teeth	Length (in.)
MD463	1 x 2	7

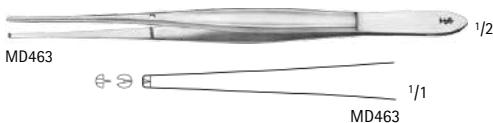

BROPHY FORCEPS, DELICATE

Catalog Number	Tip	Length (in.)
BD246R	SERR	7 7/8

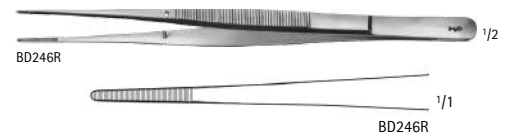

CUSHING FORCEPS, DELICATE

Catalog Number	Tip	Length (in.)
BD238R	STR, SERR	7
BD239R	STR, SERR	7 7/8
BD240R	STR, SERR	9 3/4
BD243R	CVD, SERR	7 7/8

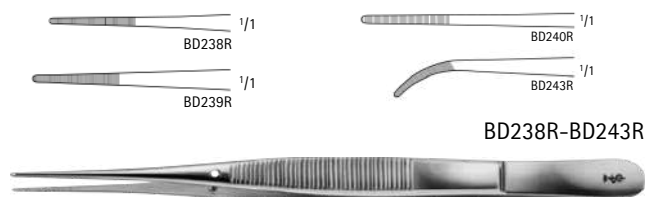

GENERAL SURGERY

Dressing and Tissue Forceps

FORCEPS, DELICATE

Catalog Number	Tip	Length (in.)
BD231R	SMOOTH	7
BD232R	SMOOTH	7 7/8

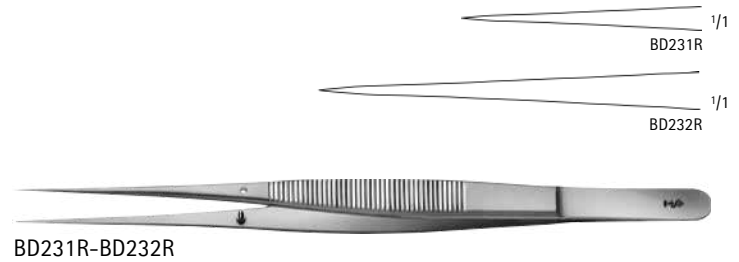

MICRO DRESSING FORCEPS

Catalog Number	Tip	Length (in.)
BD301R	STR, SERR	3 1/2
BD302R	STR, SERR	4 1/8
BD303R	STR, SERR	4 1/2
BD304R	STR, SERR	5 1/8
BD305R	STR, SERR	5 3/4
BD311R	CVD, SERR	3 1/2
BD312R	CVD, SERR	4 1/8
BD313R	CVD, SERR	4 1/2
BD314R	CVD, SERR	5 1/8
BD315R	CVD, SERR	5 3/4

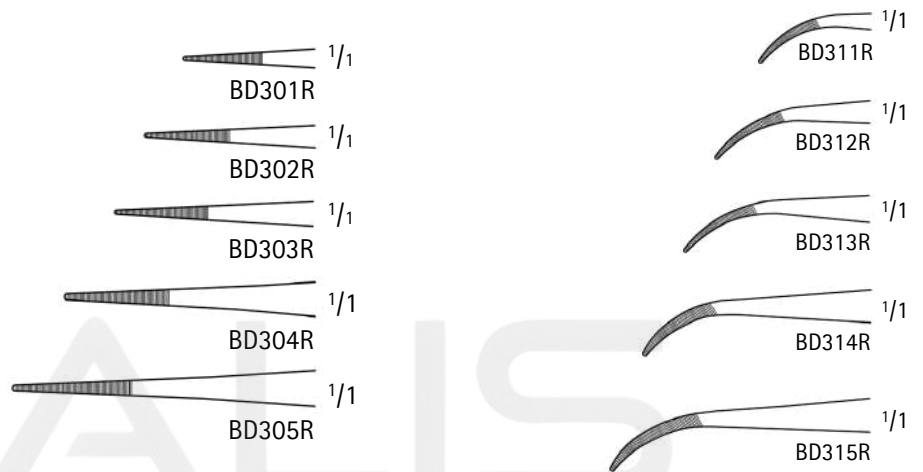
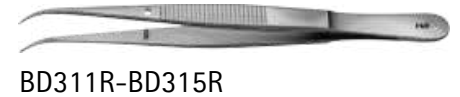

MICRO TISSUE FORCEPS

Catalog Number	Teeth	Length (in.)
BD500R	1 x 2	4
BD501R	1 x 2	4 1/4
BD502R	2 x 3	4 1/4

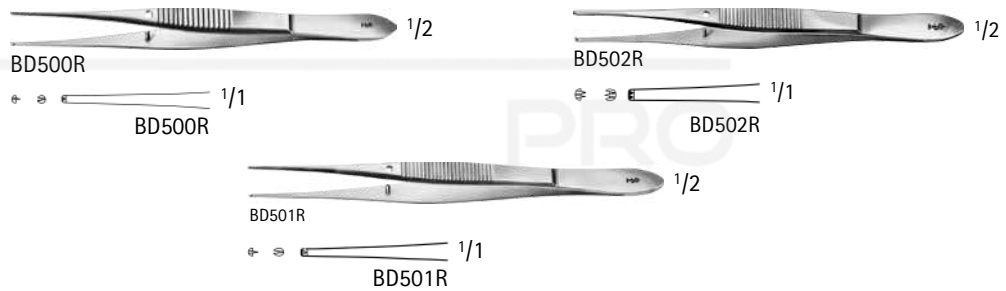

DEBAKEY ATRAUMATIC ULTRA LIGHT FORCEPS

Catalog Number	Tip Size (mm)	Length (in.)
FC411R	1.2	6
FC412R	1.5	7 7/8
FC413R	1.5	9 1/2
FC418R	1.5	11 3/4

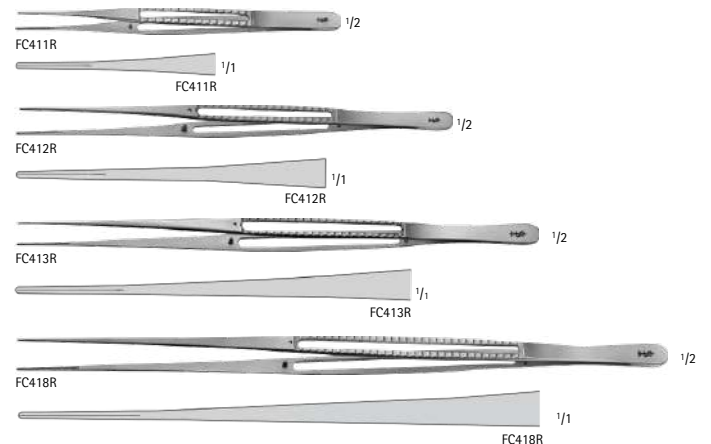

MICRO FORCEPS #3

JEWELERS

Catalog Number	Tip Size (mm)	Length (in.)
BD335R	0.3	5 1/4



GILLIES TISSUE

FORCEPS, DELICATE

Catalog Number	Tip	Teeth	Length (in.)
BD660R	X-SERR	1 x 2	6 1/8



SEMKEN TISSUE

FORCEPS, DELICATE

Catalog Number	Teeth	Length (in.)
BD669R	1 x 2	5 3/4



MICRO FORCEPS #5

JEWELERS

Catalog Number	Tip Size (mm)	Length (in.)
BD331R	0.15	4 1/4



MICRO FORCEPS #4

JEWELERS

Catalog Number	Tip Size (mm)	Length (in.)
BD330R	0.2	4 1/4



DOCKTOR FORCEPS

Catalog Number	Tip	Teeth	Length (in.)
MB211R	X-SERR	1 x 2	4 3/4



MICRO FORCEPS #7 JEWELERS

Catalog Number	Tip Size (mm)	Length (in.)
BD333R	0.2	4 1/2



Dressing and Tissue Forceps

WAUGH TISSUE FORCEPS, DELICATE

Catalog Number	Tip	Teeth	Length (in.)
BD670R	X-SERR	1 x 2	7
BD671R	X-SERR	1 x 2	7 7/8
BD672R	X-SERR	1 x 2	9 3/4
BD679R	X-SERR	1 x 2	12

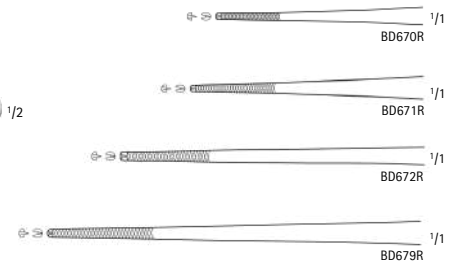

DEBAKEY ATRAUMATIC FORCEPS

Catalog Number	Tip Size (mm)	Length (in.)
FB411R	1.5	6
FB412R	1.5	7 7/8
FB418R	1.5	9 1/2
FB419R	1.5	11 3/4

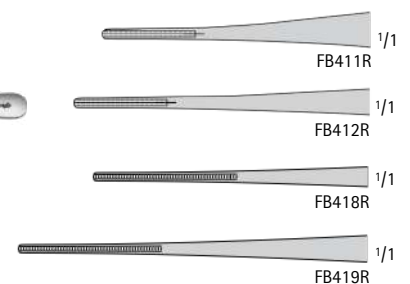

DEBAKEY ATRAUMATIC FORCEPS

Catalog Number	Tip Size (mm)	Length (in.)
FB400R	2	6
FB402R	2	7 7/8
FB404R	2	9 1/2
FB405R	2	11 3/4
FB414R	2.8	6
FB415R	2.8	7 7/8
FB416R	2.8	9 1/2
FB417R	2.8	11 3/4
FB406R	3.5	7 7/8
FB407R	3.5	9 1/2
FB408R	3.5	11 3/4
FB409R	3.5	13 3/4

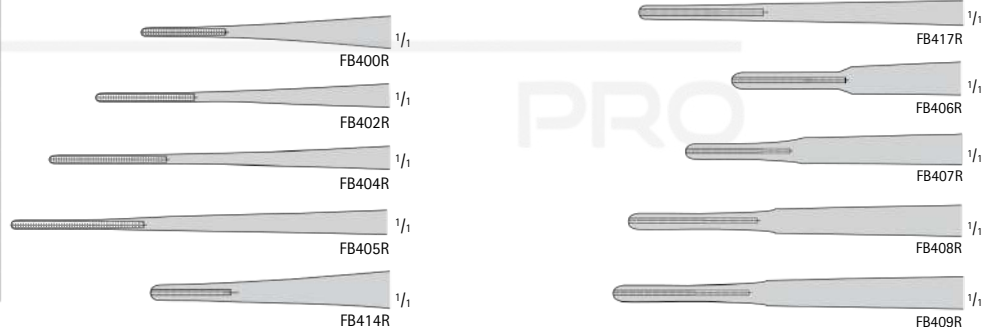

DEBAKEY ATRAUMATIC VASCULAR TISSUE FORCEPS

Catalog Number	Tip Size (mm)	Length (in.)
FB394R	1	6
FB395R	1	7 3/4
FB396R	1	9 1/2

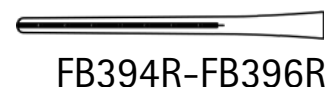

DEBAKEY ATRAUMATIC FORCEPS, ANGLED

Catalog Number	Tip Size (mm)	Length (in.)
FB401R	2	6
FB403R	2	7 7/8
FB410R	2	9 1/2

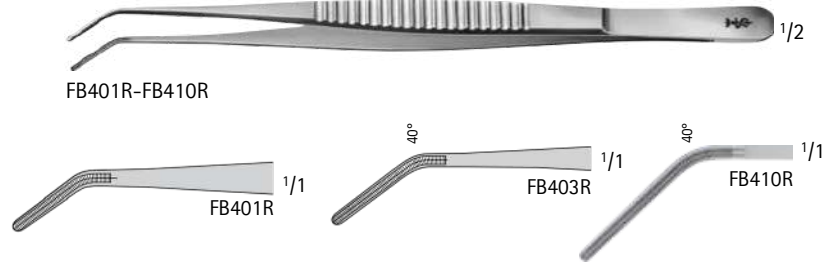

COOLEY ATRAUMATIC VASCULAR TISSUE FORCEPS

Catalog Number	Tip Size (mm)	Length (in.)
FB784R	1.5	6
FB785R	2.0	7 3/4
FB786R	2.3	9 1/2

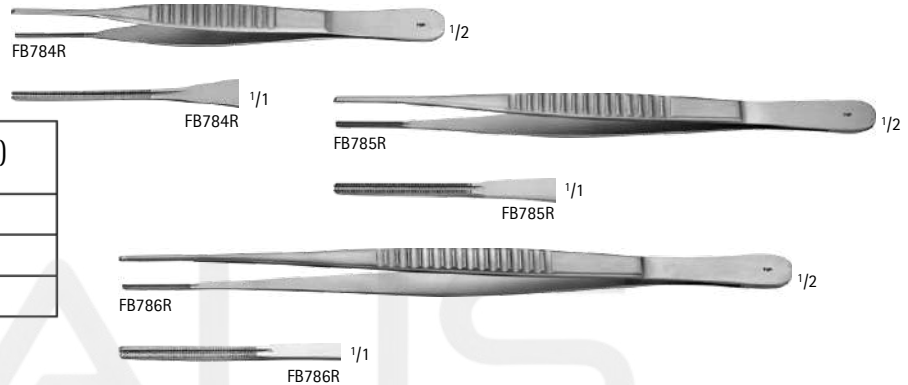

COOLEY VASCULAR TISSUE FORCEPS

Catalog Number	Length (in.)
BD250R	7 7/8



MILLS MAMMARY/CORONARY TISSUE FORCEPS

Catalog Number	Length (in.)
BD770R	7



DILATOR FORCEPS

Catalog Number	Tip Size (mm)	Length (in.)
FB130R	0.2	4 1/2



HUNTER SPLINTER FORCEPS

Catalog Number	Length (in.)
BD980R	4 1/8



GENERAL SURGERY

Alis Pro™ TC Tissue Forceps



Alis Pro Tungsten Carbide Tissue Forceps ■ Cross-Serrated Platform tips for firm and non-traumatic grip ■ Long working life ■ Gold-plated end

ALIS PRO TC WANGENSTEEN FORCEPS

Catalog Number	Tip	Length (in.)
BD171R	X-SERR	6
BD173R	X-SERR	9

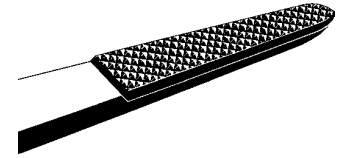
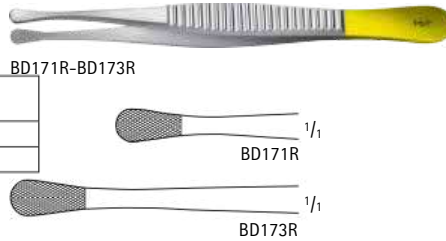

ALIS PRO TC ADSON FORCEPS

Catalog Number	Tip	Teeth	Length (in.)
BD151R	X-SERR	-	4 3/4
US109	X-SERR	1 x 2	4 3/4
US110	X-SERR	1 x 2	4 3/4
MB484R	DEL, X-	1 x 2	4 3/4
MB485RDE	SERR X-	1 x 2	6
L, X-SERR	SERR	1 x 2	6

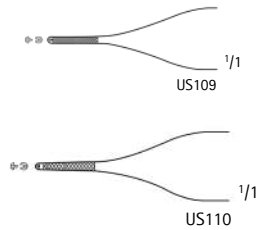
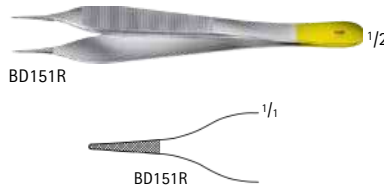

ALIS PRO TC DEBAKEY NEEDLE FORCEPS

Catalog Number	Tip	Tip Size (mm)	Length (in.)
MB782R	-	1.5	6
MB783R	-	1.5	7 3/4
US119	NARROW	1.5	7 3/4
MB779R	-	2	6
MB780R	-	2	8
MB781R	-	2	10 1/2
US117	-	2	6
US118	-	2	8
US120	NARROW	2	9

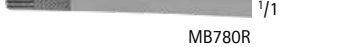
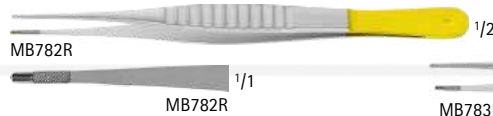

ALIS PRO TC (POTTS-SMITH) THUMB FORCEPS

Catalog Number	Tip	Length (in.)
BD154R	X-SERR	5 3/4
BD156R	X-SERR	7
BD157R	X-SERR	7 7/8
BD158R	X-SERR	9
BD159R	X-SERR	9 3/4

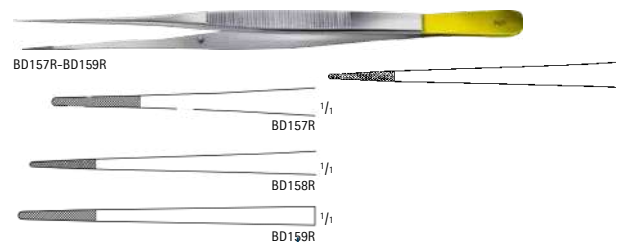
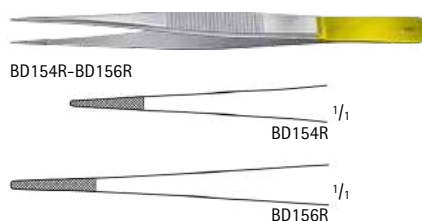

ALIS PRO TC GORNEY-ADSON FORCEPS

Catalog Number	Tip	Teeth	Length (in.)
US112	DEL, SMOOTH	1 x 2	4 3/4

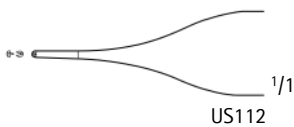

GERALD NEEDLE FORCEPS

Catalog Number	Tip	Teeth	Length (in.)
MG356R	X-SERR	1 x 2	6 7/8



ALIS PRO TC CUSHING FORCEPS, W/ SCRAPER END

Catalog Number	Tip	Length (in.)
BD160R	X-SERR	7
BD198R	X-SERR	9 3/4



BD160R-BD198R

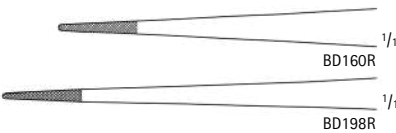

ALIS PRO TC CUSHING FORCEPS

Catalog Number	Tip	Length (in.)
MB308RANG, X-SERR		6 1/4



ALIS PRO TC STANDARD FORCEPS

Catalog Number	Tip	Length (in.)
BD164R	X-SERR	5 3/4
BD165R	X-SERR	7 7/8
BD166R	X-SERR	9 3/4

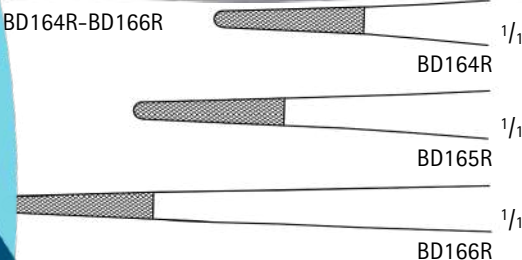

ALIS PRO TC SEMKEN FORCEPS

Catalog Number	Tip	Tip Size (mm)	Teeth	Length (in.)
US111	X-SERR	1	1 x 2	6 1/4

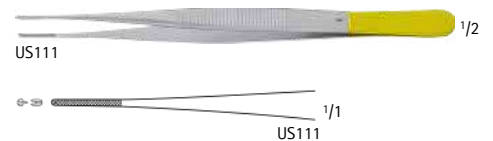

ALIS PRO TC GRUENWALD FORCEPS

Catalog Number	Tip	Length (in.)
BD168R	X-SERR	7 1/4



Abdominal and Intestinal Grasping Forceps

LAHEY FORCEPS

Catalog Number	Teeth	Length (in.)
BF309R	2 x 2	6 1/8
BF310R	3 x 3	6 1/8
MG360R	3 x 3	8
BF311R	4 x 4	6 1/8

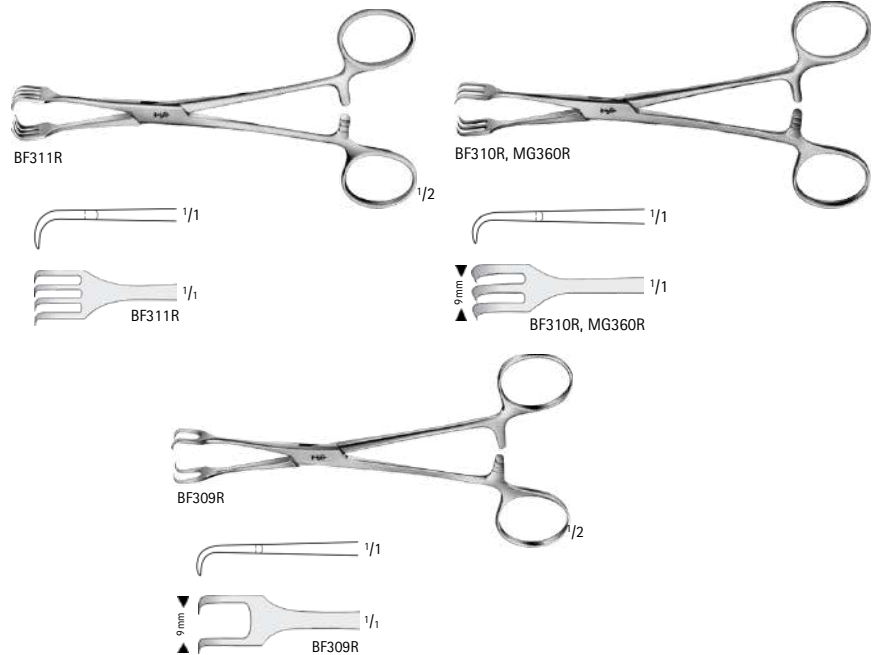

ALLIS FORCEPS, HEAVY VERSION

Catalog Number	Teeth	Length (in.)
MG235R	4 x 5	6 1/8
MG236R	5 x 6	6 1/8
MG237R	5 x 6	7 7/8



ALLIS ATRAUMATIC FORCEPS

Catalog Number	Length (in.)
EA092R	6 1/4
EA095R	7 7/8
EA096R	8 3/4
EA097R	10
EA100R	11 5/8
EA099R	11 3/4
EA101R	14

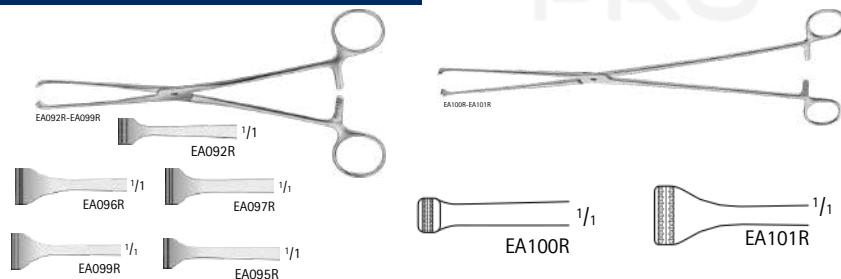

ALLIS FORCEPS

Catalog Number	Teeth	Length (in.)
EA015R	4 x 5	6 1/8
EA016R	5 x 6	6 1/8
EA017R	5 x 6	7 1/2
FB938R	5 x 6	8 3/4
EA018R	5 x 6	10
MB910R	5 x 6	16

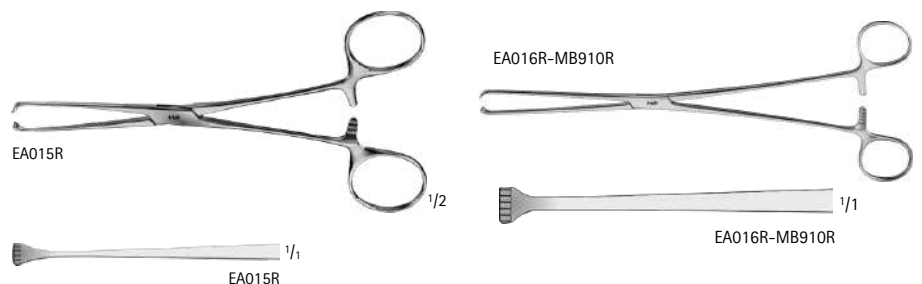

GENERAL SURGERY

Abdominal and Intestinal Grasping Forceps

BOYS-ALLIS FORCEPS

Catalog Number	Teeth	Length (in.)
EA010R	5 x 6	6 1/8

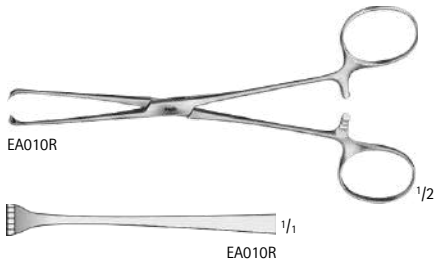

BABY ALLIS FORCEPS

Catalog Number	Teeth	Length (in.)
EA012R	4 x 5	5 1/8

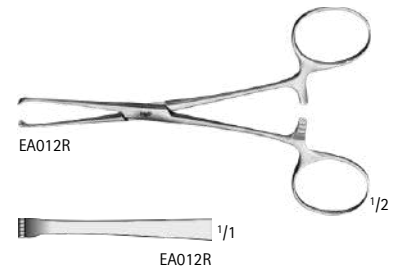

ALLIS-THOMS FORCEPS

Catalog Number	Teeth	Length (in.)
EA020R	6 x 7	7 7/8

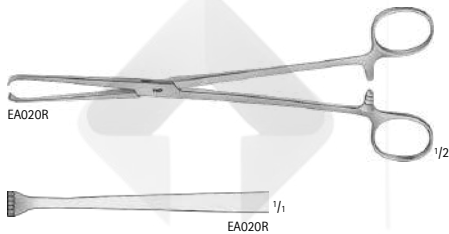

JUDD-ALLIS FORCEPS

Catalog Number	Teeth	Length (in.)
EA025R	3 x 4	6 1/8
EA026R	3 x 4	7 7/8

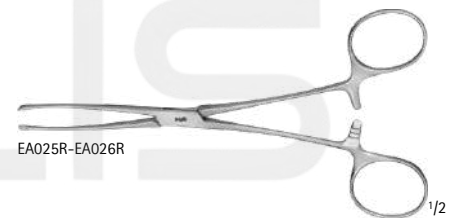

LOCKWOOD-ALLIS

INTESTINAL CLAMP

Catalog Number	Teeth	Length (in.)
MG455R	4 x 5	6 1/2

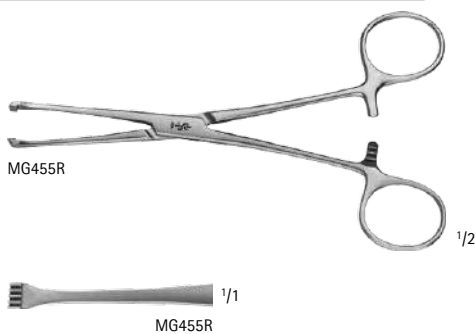

ALLIS-ADAIR CLAMP

Catalog Number	Teeth	Length (in.)
MD568	9 x 10	6 1/4

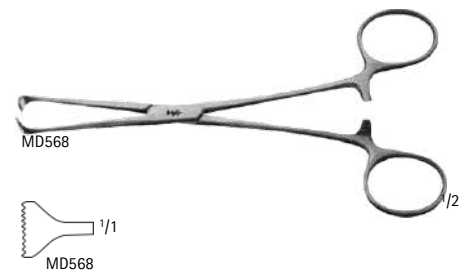

GENERAL SURGERY

Abdominal and Intestinal Grasping Forceps

GLASSMAN-ALLIS COMMON DUCT FORCEPS NON-CRUSHING

Catalog Number	Length (in.)
MG435R	8 1/2

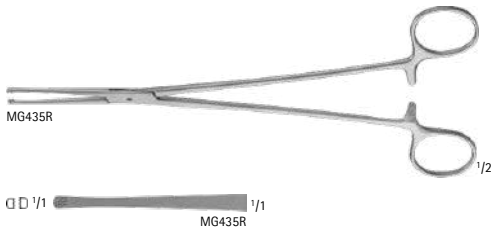

BABCOCK TISSUE HOLDING FORCEPS

Catalog Number	Length (in.)
MB136R	12
MB137R	14

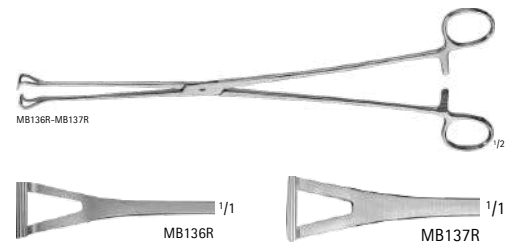

BABCOCK FORCEPS

Catalog Number	Tip	Length (in.)
MG359R	-	5 1/2
EA030R	-	6 1/8
EA031R	-	6 7/8
EA032R	-	8 1/2
FB934R	-	8 3/4
MB300R	-	14
MB911R	DEL, PETITE	16

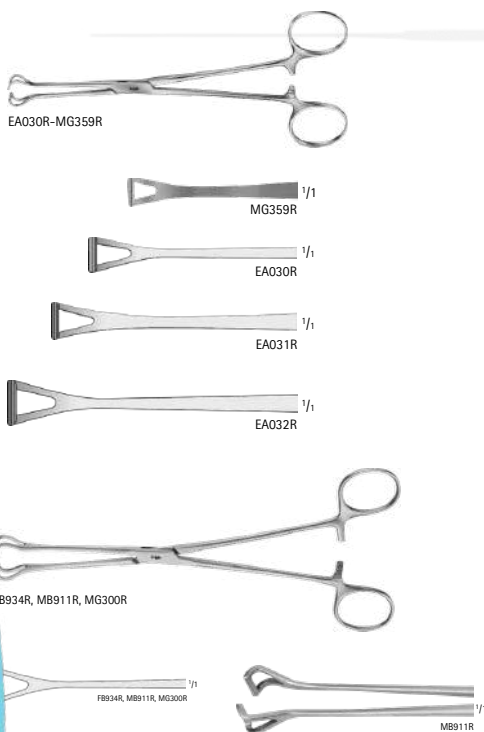

ALIS PRO™ TC BABCOCK FORCEPS

Catalog Number	Length (in.)
MG364R	6 1/4
MB338R	8 1/4

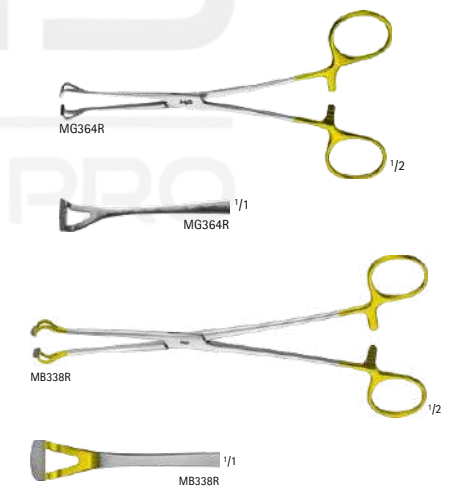

ALLIS INTESTINAL GRASPING FORCEPS

Catalog Number	Length (in.)
EA022R	7 1/2
EA023R	11 1/2

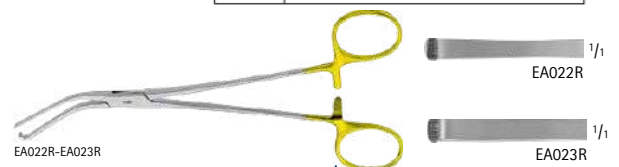

GENERAL SURGERY

Abdominal and Intestinal

Grasping Forceps

BABCOCK ATRAUMATIC FORCEPS

Catalog Number	Length (in.)
EA050R	6 1/4
EA052R	8 1/2
FB936R	8 3/4
MD470	9 1/2

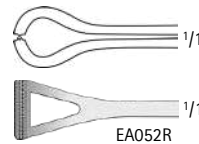
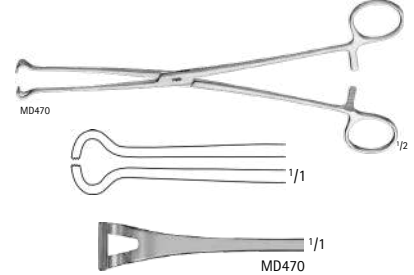
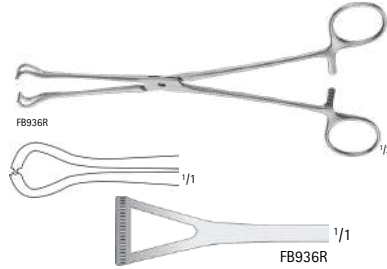

COLLIN INTESTINAL FORCEPS

Catalog Number	Length (in.)
EA039R	5 1/2
EA040R	7



DUVAL-COLLIN INTESTINAL FORCEPS

Catalog Number	Length (in.)
EA041R	7 3/4
EA042R	7 7/8

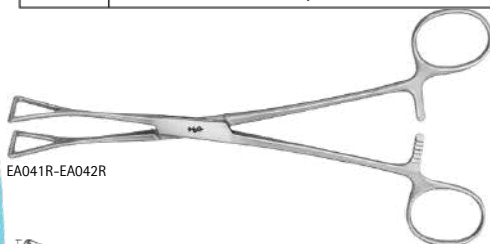

COLLIN ATRAUMATIC FORCEPS

Catalog Number	Length (in.)
EA061R	7 3/4
EA062R	9

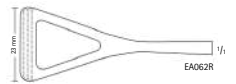
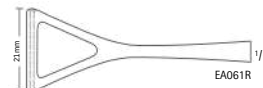
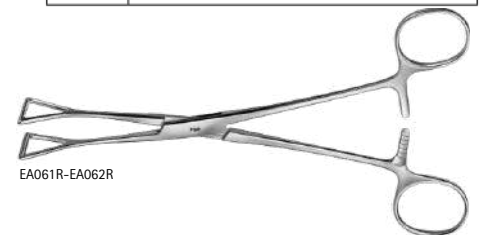

GENERAL SURGERY

Abdominal and Intestinal Grasping Forceps

ALLEN INTESTINAL FORCEPS, LONGITUDINAL SERRATED

Catalog Number	Teeth	Length (in.)
EA114R	1 x 2	6 1/8
MB609R	1 x 2	7 7/8

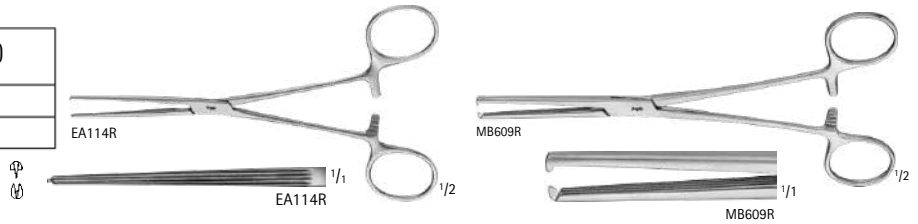

PENNINGTON FORCEPS

Catalog Number	Length (in.)
BH902R	6 1/8
EA037R	7 7/8

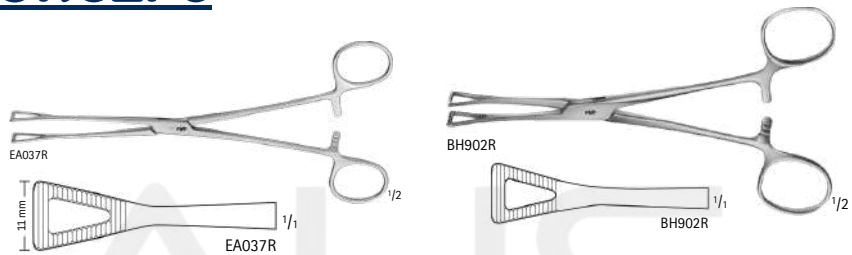

DOYEN INTESTINAL FORCEPS, ELASTIC BLADES

Catalog Number	Jaw	Length (in.)
EA120R	STR	6 1/2
EA126R	STR	9 1/4
EA121R	CVD	6 1/2
EA127R	CVD	9 1/4



BAINBRIDGE INTESTINAL FORCEPS, LONGITUDINAL SERRATIONS

Catalog Number	Jaw	Length (in.)
EA106R	STR	6 1/8
US114	STR	7 1/4
EA107R	CVD	6 1/8
US115	CVD	7 1/4

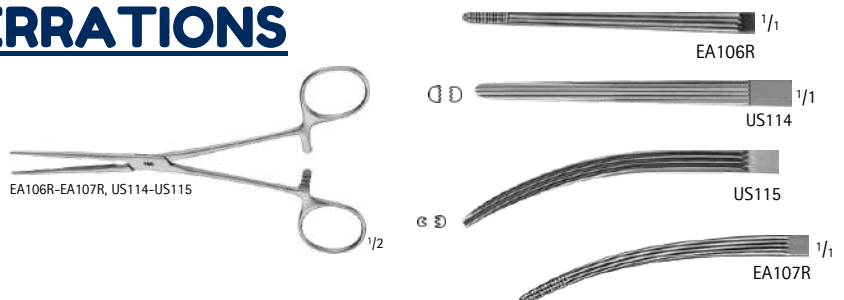

GENERAL SURGERY

Abdominal and Intestinal

Grasping Forceps

DOYEN INTESTINAL FORCEPS, ELASTIC BLADES, LONGITUDINAL SERATIONS

Catalog Number	Jaw	Length (in.)
EA130R	STR	9 1/2
EA131R	CVD	9 1/2

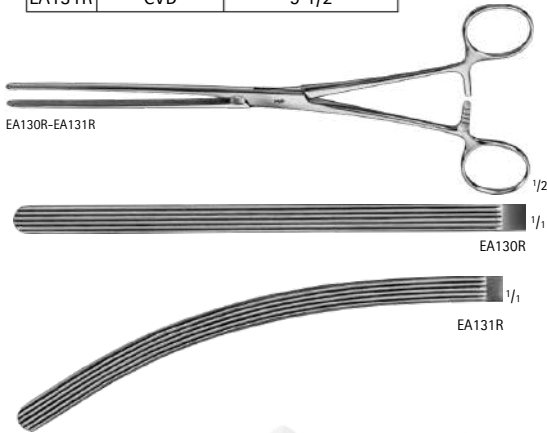

HARTMANN INTESTINAL CLAMP, ELASTIC BLADES

Catalog Number	Jaw	Length (in.)
EA124R	STR	7 7/8
EA125R	CVD	7 7/8

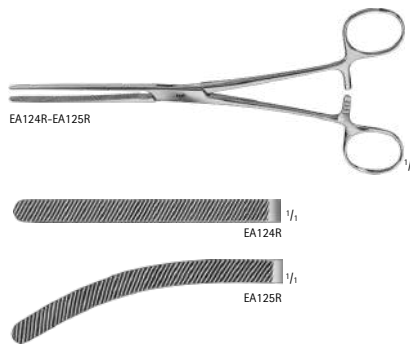

MAYO-ROBSON INTESTINAL FORCEPS, HARD ELASTIC BLADES

Catalog Number	Jaw	Length (in.)
EA170R	STR	9 3/4
EA171R	CVD	9 3/4

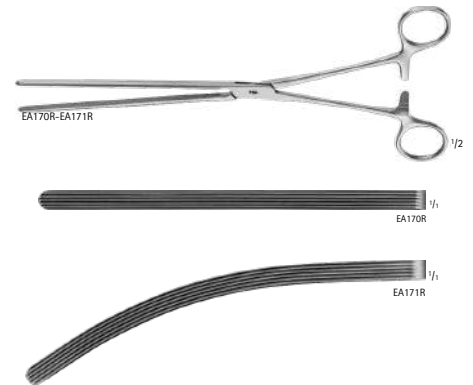

KOCHER INTESTINAL FORCEPS, ELASTIC BLADES

Catalog Number	Jaw	Length (in.)
EA116R	STR	6 1/8
EA140R	STR	8 1/4
EA145R	STR	9
EA117R	CVD	5 1/4
EA141R	CVD	8 1/4
EA146R	CVD	9

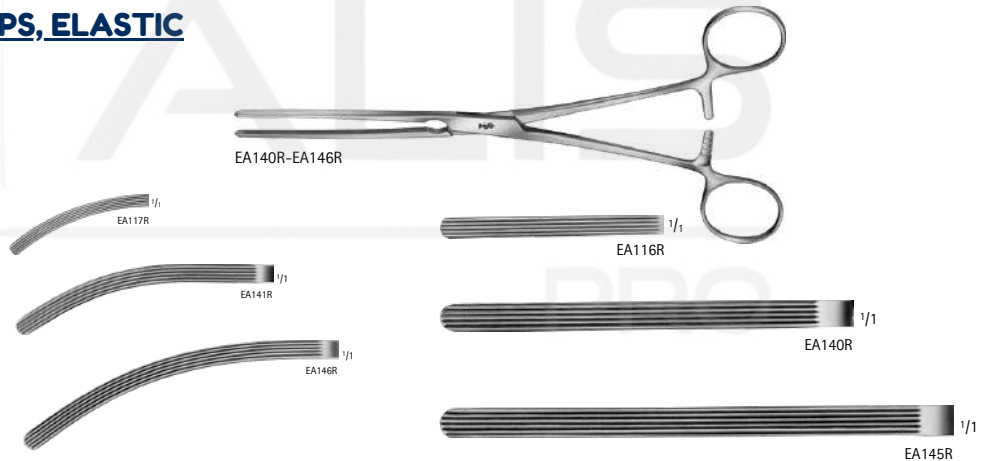

KOCHER INTESTINAL FORCEPS, ELASTIC BLADES

Catalog Number	Jaw	Length (in.)
EA150R	STR	8 3/4
EA151R	STR	9 3/4
EA152R	STR	11
EA155R	CVD	8 3/4
EA156R	CVD	9 3/4

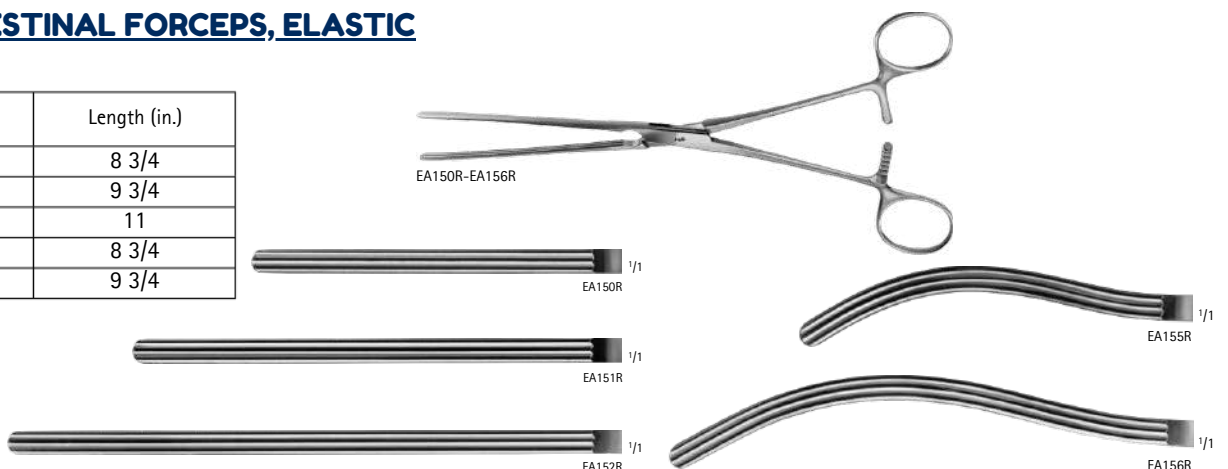

GENERAL SURGERY

Abdominal and Intestinal

Forceps

PAYR INTESTINAL CLAMP

Catalog Number	Length (in.)
EA305R	7
EA306R	7 7/8
EA309R	10 3/4
EA450R	12 1/2

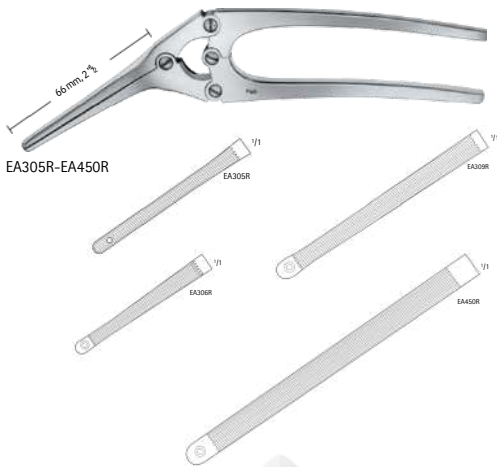

DEMARTEL-WOLFSON ANASTOMOSIS CLAMP

Catalog Number	Description	Length (in.)
EA331R	SET OF 3	4
EA332R	SET OF 3	4 3/4



EA331R-EA332R

CLAMP HOLDER FOR ANASTOMOSIS CLAMP

Catalog Number	Description	Length (in.)
EA334R	3" FOR USE WITH EA331R-EA332R	3 1/8

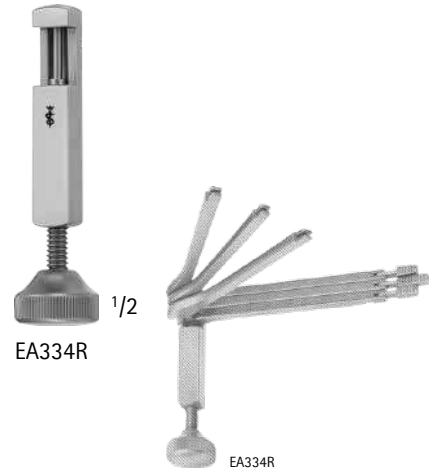

KLEINSCHMIDT APPENDECTOMY FORCEPS

Catalog Number	Jaw	Length (in.)
EA397R	CVD	5 1/8

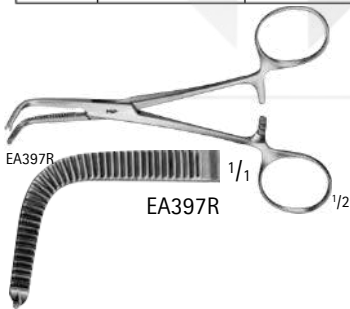

BENSON PYLORUS SPREADER

Catalog Number	Length (in.)
EA466R	6 1/8



TAUFIC CHOLIANGIOGRAPHY CLAMP

Catalog Number	Length (in.)
MG454R	8 1/2

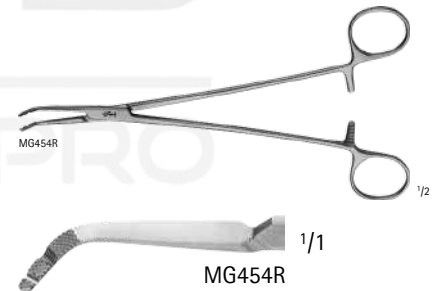

PRATT-SMITH HEMOSTATIC "T" FORCEPS

Catalog Number	Length (in.)
MD582	6 1/8

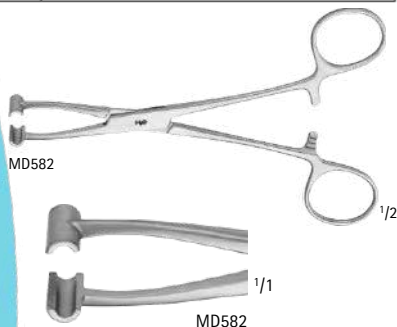

PURSE STRING CLAMP

Catalog Number	Jaw Length (mm)	Length (in.)
EA323R	50	11

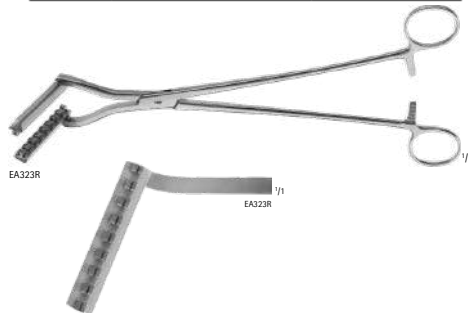

LOWER GALL DUCT FORCEPS

Catalog Number	Jaw	Length (in.)
EB001R	HEAVY-CVD	7

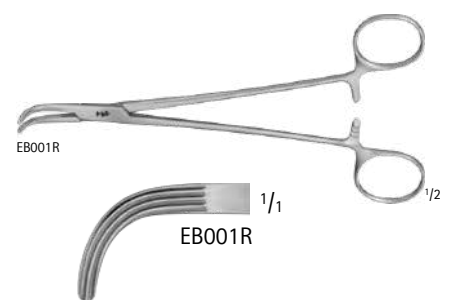

GENERAL SURGERY

Abdominal and Intestinal

Forceps

LAHEY (SWEET) GALL DUCT FORCEPS

Catalog Number	Jaw	Length (in.)
EB003R	CVD	7 7/8

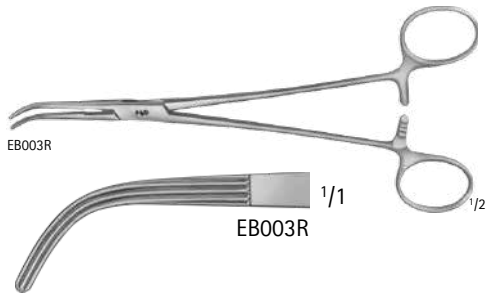

DESJARDINS GALL DUCT FORCEPS

Catalog Number	Jaw	Length (in.)
EB008R	HEAVY-CVD	8 3/4

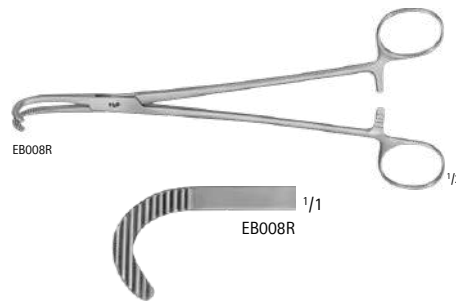

LAHEY GALL DUCT FORCEPS

Catalog Number	Jaw	Length (in.)
EB004R	HEAVY-CVD	7 1/2

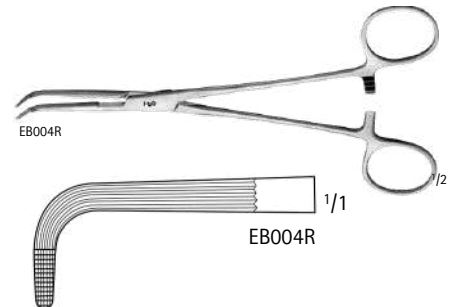

GRAY CYSTIC GALL DUCT FORCEPS

Catalog Number	Jaw	Length (in.)
EB011R	SHORT, CVD	8 3/4
EB012R	LONG, CVD	8 3/4

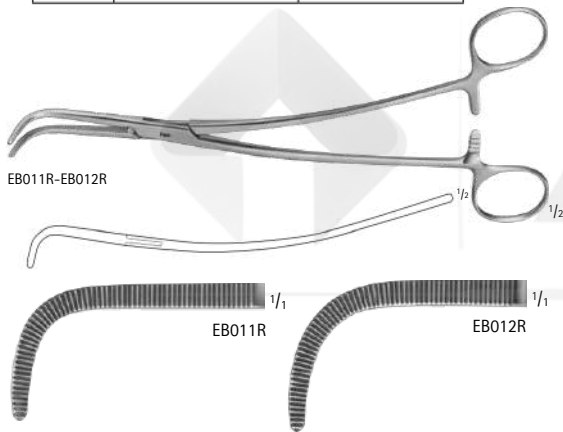

MIXTER GALL DUCT FORCEPS

Catalog Number	Jaw	Length (in.)
MB120R	HEAVY-CVD	6 1/4

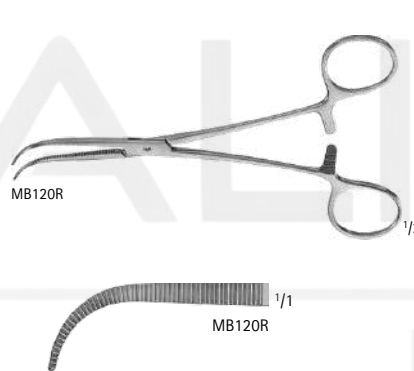

SHALLCROSS CYSTIC DUCT FORCEPS

Catalog Number	Jaw	Length (in.)
MB126R	CVD	6 7/8
US152	FULL-CVD	8

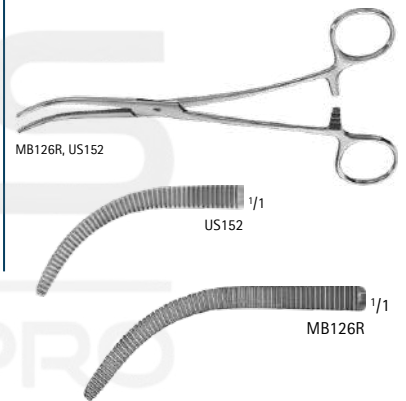

BLAKE GALL STONE FORCEPS

Catalog Number	Jaw	Length (in.)
EB220R	STR	8
EB221R	CVD	8

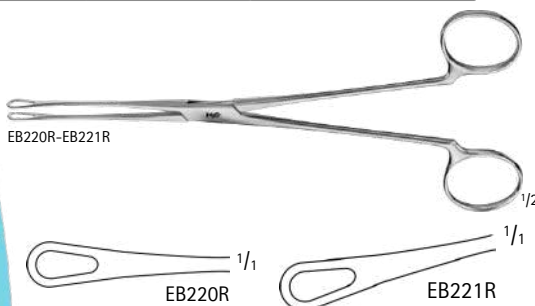

DESJARDINS GALL STONE FORCEPS

Catalog Number	Tip	Length (in.)
EB231R	OVAL	8 7/8
EB232R	OVAL	8 7/8
EB233R	TAPERED	8 7/8
EB234R	TAPERED	8 7/8

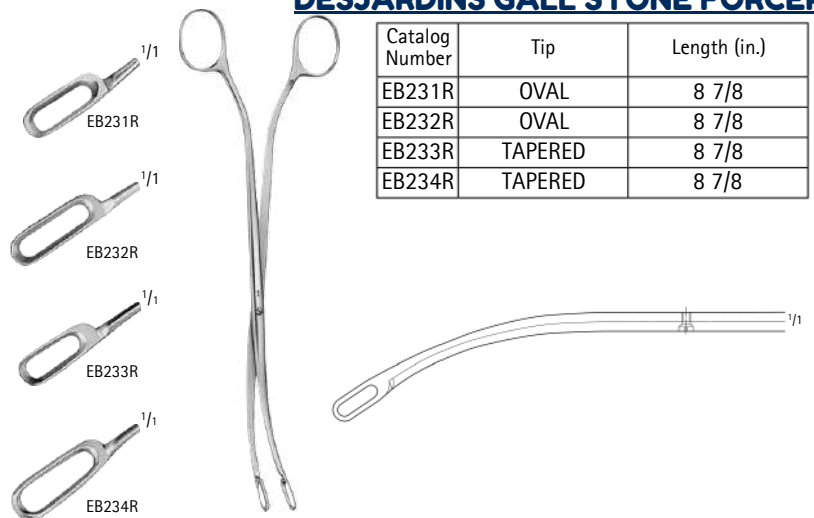

GENERAL SURGERY

Abdominal and Intestinal

Forceps

PARKER-KERR FORCEPS

Catalog Number	Jaw	Length (in.)
EA365R	SLIGHT-CVD	9 3/4

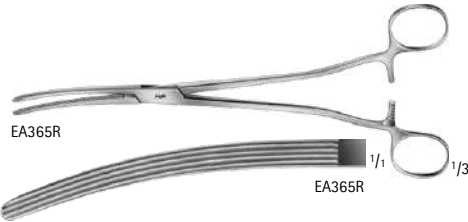

HEIMING KIDNEY STONE FORCEPS

Catalog Number	Jaw	Length (in.)
EF047R	SLIGHT-CVD	6 3/4
EF048R	HEAVY-CVD	6 1/4



RANDALL KIDNEY STONE FORCEPS

Catalog Number	Jaw	Length (in.)
EF051R	SLIGHT-CVD	8 7/8
EF052R	CVD	8 7/8
EF053R	HEAVY-CVD	8 7/8
EF054R	U-CVD	8 7/8

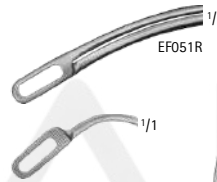

RANDALL KIDNEY STONE FORCEPS (CONTINUED)

Catalog Number	Jaw	Length (in.)
EF055R	CVD	7 1/2
EF056R	HEAVY-CVD	7 1/2
EB244R	90° ANG	9 5/8
EB246R	HEAVY-CVD, DEL	9

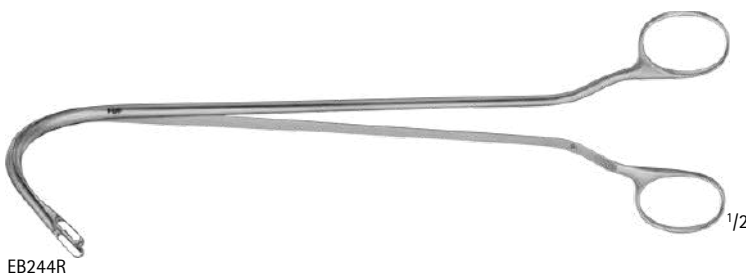
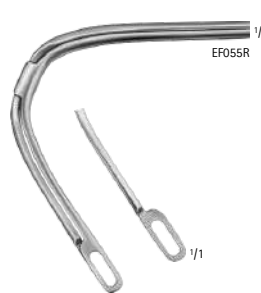

GENERAL SURGERY

Abdominal and Intestinal

Forceps

KOCHER ATRAUMATIC FORCEPS, ELASTIC BLADES

Catalog Number	Jaw	Length (in.)
EA202R	STR	8 3/4
EA204R	STR	9 3/4
EA206R	STR	11
EA203R	CVD	8 3/4
EA205R	CVD	9 3/4
EA207R	CVD	11

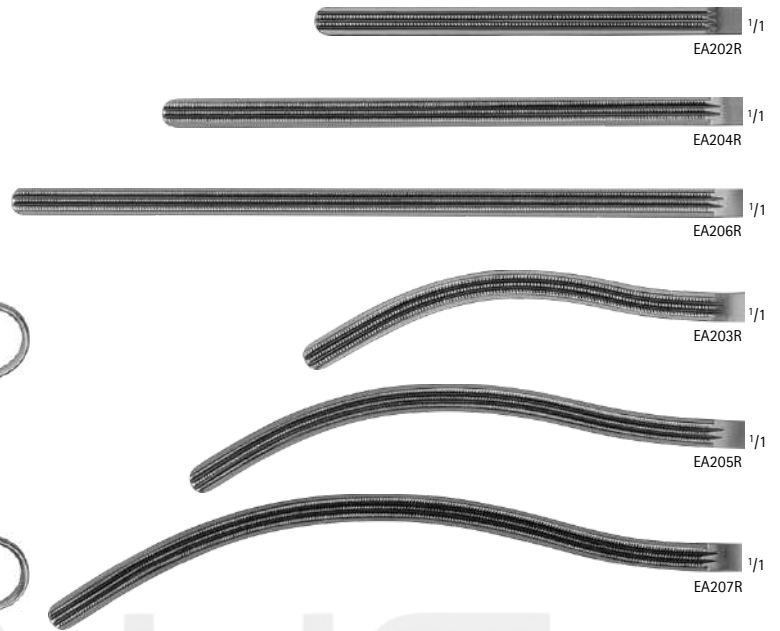
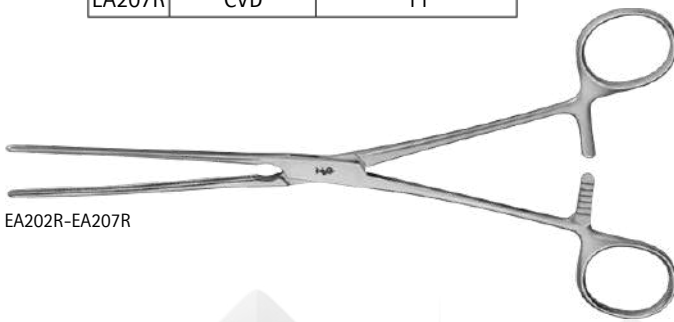

HARTMANN ATRAUMATIC FORCEPS, ELASTIC BLADES

Catalog Number	Jaw	Length (in.)
EA210R	STR	7 7/8
EA211R	CVD	7 7/8

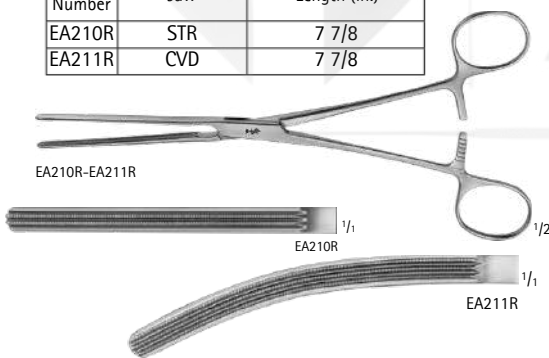

MAYO-ROBSON ATRAUMATIC FORCEPS

Catalog Number	Jaw	Length (in.)
EA216R	STR	9 3/4
EA217R	CVD	9 3/4



DOYEN ATRAUMATIC FORCEPS, ELASTIC BLADES

Catalog Number	Jaw	Length (in.)
EA222R	STR	6 3/4
EA212R	STR	9
EA223R	CVD	6 3/4
EA213R	CVD	9

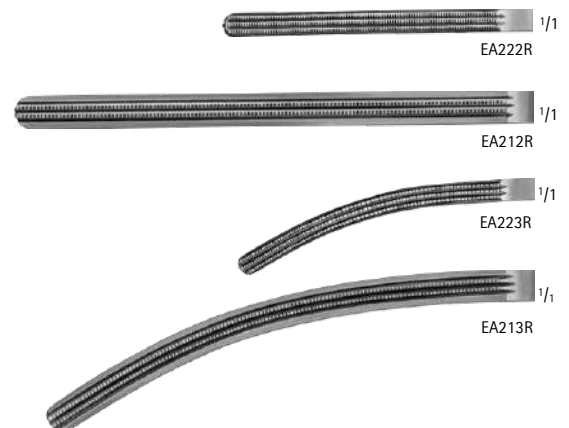
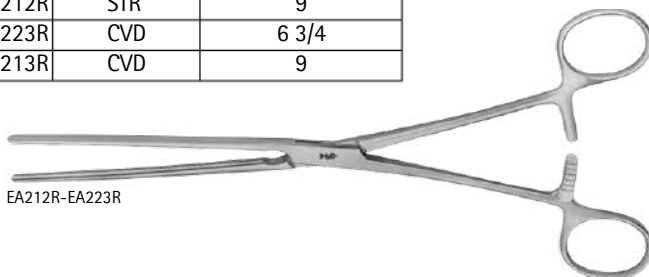

GENERAL SURGERY

Atraumatic Intestinal Forceps and Clamps

SCUDDER ATRAUMATIC FORCEPS

Catalog Number	Jaw	Length (in.)
EA240R	STR	13



GLASSMAN ANTERIOR RESECTION CLAMP

Catalog Number	Jaw	Jaw Length (mm)	Length (in.)
MB931R	90°, SERR	25	9 3/4
MB130R	90°, SERR	50	9 3/4
MB932R	90°, SERR	75	10



CARTER-GLASSMAN RESECTION CLAMP

Catalog Number	Jaw	Jaw Length (mm)	Length (in.)
MG460R	STR	110	11
MG439R	45° ANG	103	10 1/4

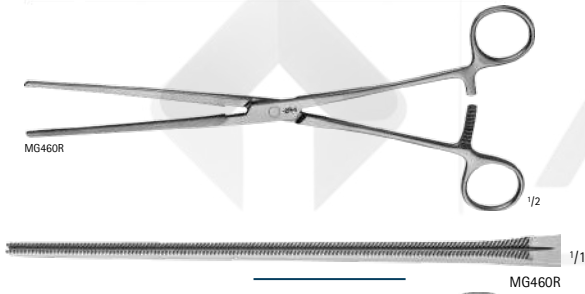

GLASSMAN INTESTINAL AND LIVER HOLDING CLAMP, NON-CRUSHING

Catalog Number	Jaw	Length (in.)
MG436R	STR	9 3/4
MG437R	CVD	9 5/8
MG438R	FULL CVD	9

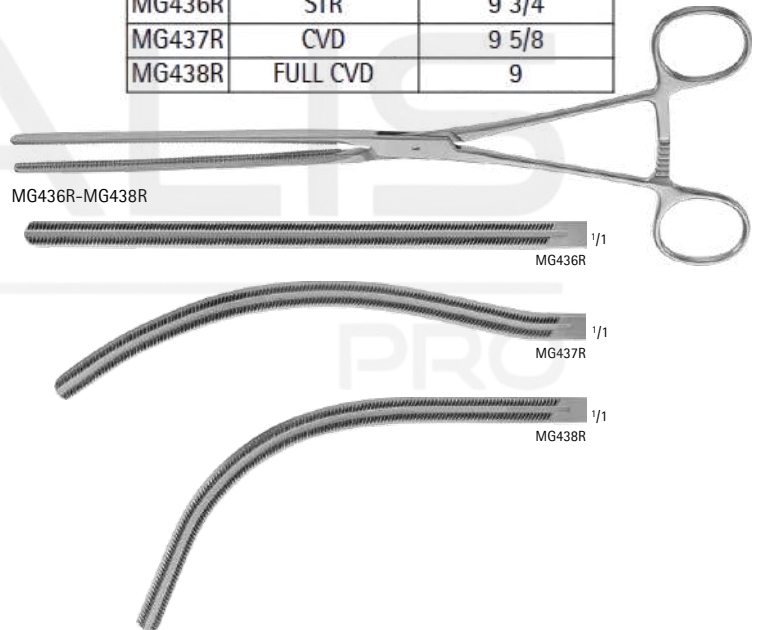

GLASSMAN GASTROENTEROSTOMY CLAMP

Catalog Number	Jaw	Jaw Length (mm)	Length (in.)
MG433R	STR	116	11 1/2
MG434R	ANG	115	11 1/2

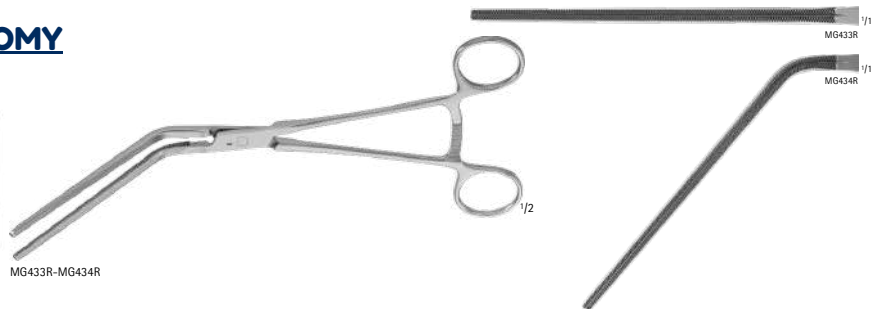

GENERAL SURGERY

Atraumatic Intestinal Forceps and Dressing and Sponge Forceps

GLASSMAN GASTROINTESTINAL CLAMP, NON-CRUSHING

Catalog Number	Jaw	Length (in.)
MB138R	STR	9 1/4
MB139R	ANG	9

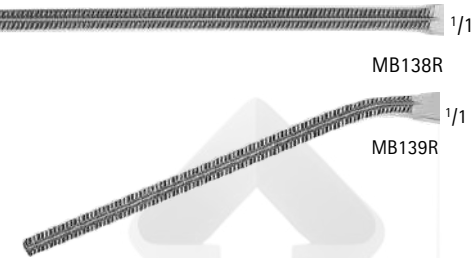

LISTER SPONGE FORCEPS

Catalog Number	Jaw	Length (in.)
BF004R	STR	5 1/4
BF006R	STR	6 1/4
BF008R	STR	7 1/4



GROSS FORCEPS, W/ RATCHET

Catalog Number	Jaw	Length (in.)
BF046R	STR	7 7/8
BF047R	CVD	7 7/8

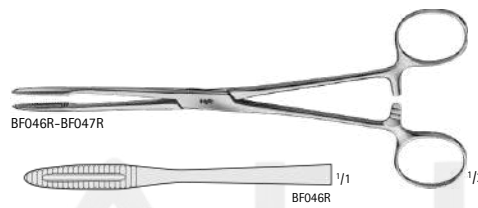

GENERAL SURGERY Dressing and Sponge Forceps

SIMS-MAIER SPONGE FORCEPS

Catalog Number	Jaw	Length (in.)
BF078R	STR	13 3/4

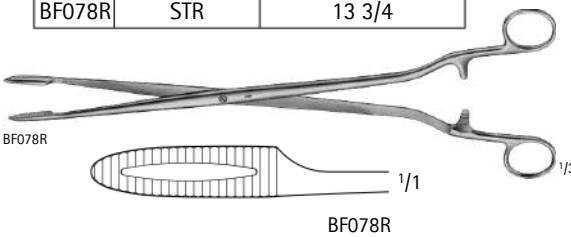

ULRICH-AESCULAP SPONGE FORCEPS

Catalog Number	Jaw	Length (in.)
BF062R	STR	10 1/2
BF063R	CVD	10 1/2
BF065R	CVD	13 3/4



RAMPLEY SPONGE FORCEPS

Catalog Number	Tip	Jaw	Length (in.)
BF116R	SERR	STR	7
BF118R	SERR	STR	9 3/4



GENERAL SURGERY

Dressing and Sponge Forceps

FOERSTER-BALLENGER SPONGE FORCEPS

Catalog Number	Tip	Jaw	Length (in.)
BF112R	SERR	STR	7
BF120R	SMOOTH	STR	9 5/8
BF122R	SERR	STR	9 5/8
BF113R	SERR	CVD	7
BF121R	SMOOTH	CVD	9 5/8
BF123R	SERR	CVD	9 5/8

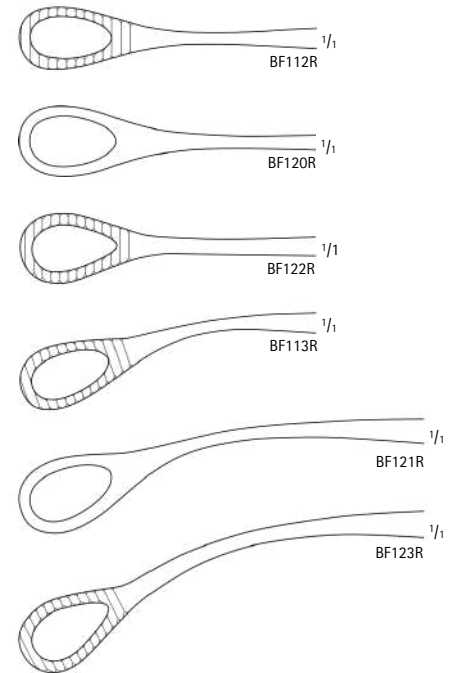

BF120R-BF123R

FOERSTER SPONGE FORCEPS

Catalog Number	Tip	Jaw	Length (in.)
MB098R	SERR	STR	12
MB099R	SERR	STR	14
MB904R	SERR	STR	16



B098R-MB904R

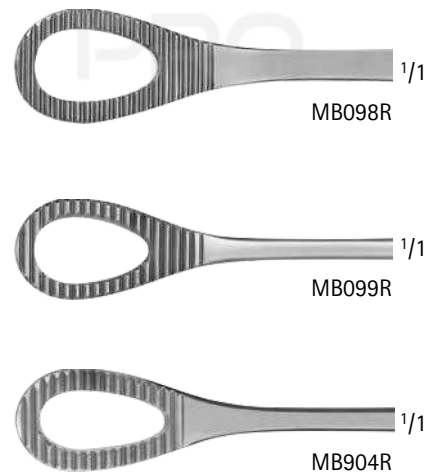

GENERAL SURGERY

Dressing and Sponge Forceps

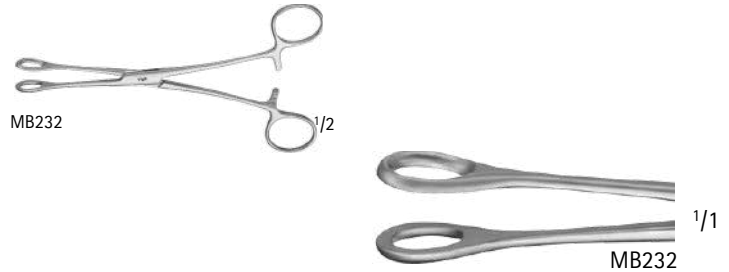
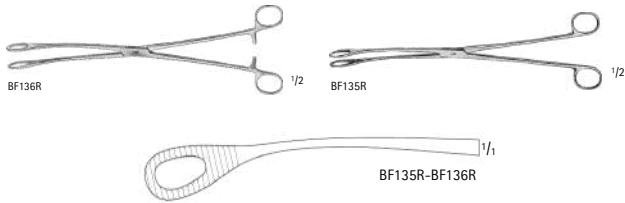

KELLY SPONGE FORCEPS

Catalog Number	Tip	Jaw	Handle	Length (in.)
BF135R	SERR	CVD	W/ OUT RATCHET	12 1/2
BF136R	SERR	CVD	W/ RATCHET	12 1/2

BALLENGER SPONGE FORCEPS

Catalog Number	Tip	Jaw	Length (in.)
MB232	SMOOTH	STR	7

GENERAL SURGERY Tongue Forceps

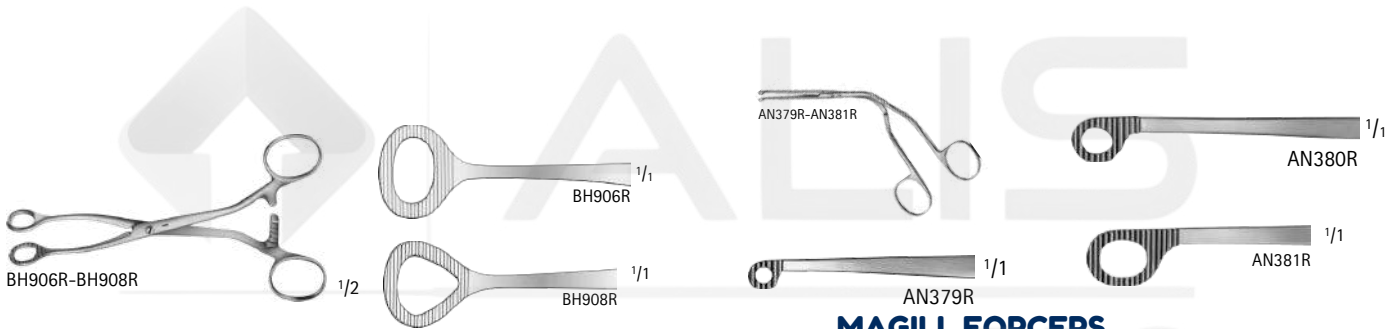

COLLIN FORCEPS W/ RATCHET

Catalog Number	Jaw	Length (in.)
BH906R	OVAL	6 1/4
BH908R	TEARDROP	6 1/4

MAGILL FORCEPS

Catalog Number	Size	Length (in.)
AN379R	INFANT	6
AN380R	PEDIATRIC	7 7/8
AN381R	ADULT	9 3/4

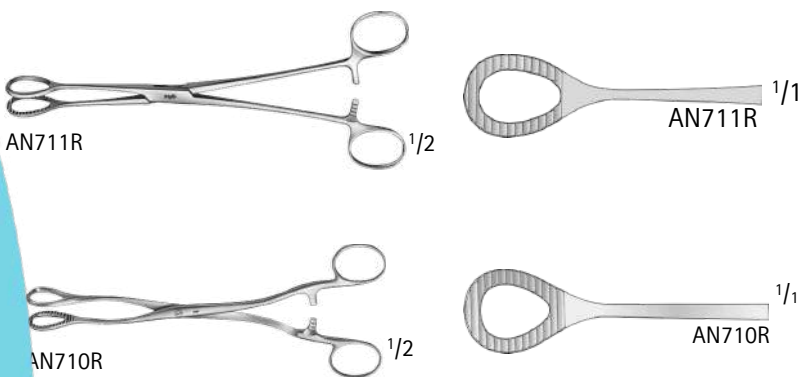

HEYWOOD-SMITH FORCEPS

Catalog Number	Tip	Length (in.)
AN710R	SERR	7 7/8
AN711R	SERR	8 1/4

GENERAL SURGERY

Biopsy Forceps

YEOMAN RECTAL BIOPSY FORCEPS

Catalog Number	Tip Size (mm)	Shaft Length (in.)
EA903R	4	16 1/2

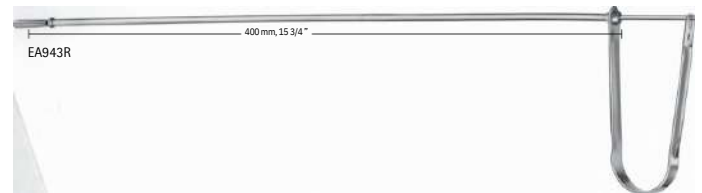
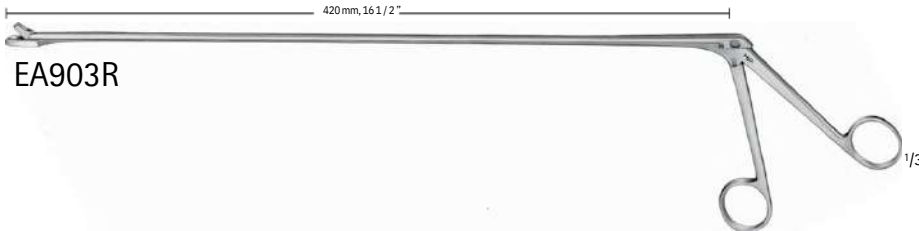

PRICE MUSCLE BIOPSY CLAMP

Catalog Number	Jaw	Jaw Size (mm)	Length (in.)
MB200R	DOUBLE-PRONG	8	4
MG098R	DOUBLE-PRONG	15	4 3/8

AESCULAP RECTAL SWAB HOLDER

Catalog Number	Shaft Length (in.)
EA943R	15 3/4

GENERAL SURGERY Hemostatic Forceps and Clamps



PEAN FORCEPS, DELICATE

Catalog Number	Jaw	Length (in.)
BH412R	STR	5 1/8
BH414R	STR	5 1/2
BH413R	CVD	5 1/8
BH415R	CVD	5 1/2

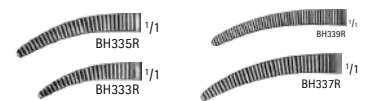
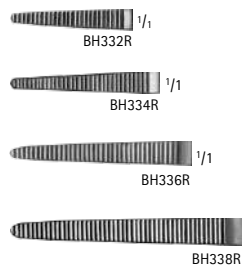
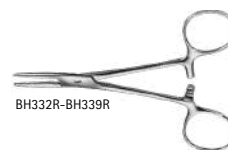

SPENCER-WELLS FORCEPS

Catalog Number	Jaw	Length (in.)
BH332R	STR	5 1/8
BH334R	STR	6
BH336R	STR	6 7/8
BH338R	STR	7 7/8
BH333R	CVD	5 1/8
BH335R	CVD	6
BH337R	CVD	6 7/8
BH339R	CVD	7 7/8

GENERAL SURGERY

Hemostatic Forceps and Clamps

PEAN ARTERY FORCEPS

Catalog Number	Jaw	Length (in.)
MB180R	CVD	12
MB181R	CVD	14

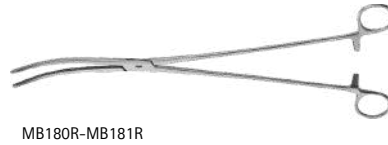

MB180R-MB181R

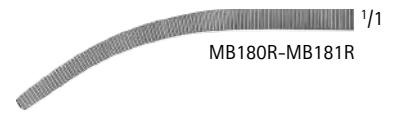

MB180R-MB181R

PEAN FORCEPS

Catalog Number	Jaw	Length (in.)
BH410R	STR	5
BH422R	STR	5 1/8
BH424R	STR	5 1/2
BH425R	CVD	5 1/2



BH410R



BH422R-BH425R



BH422R



BH424R



BH425R

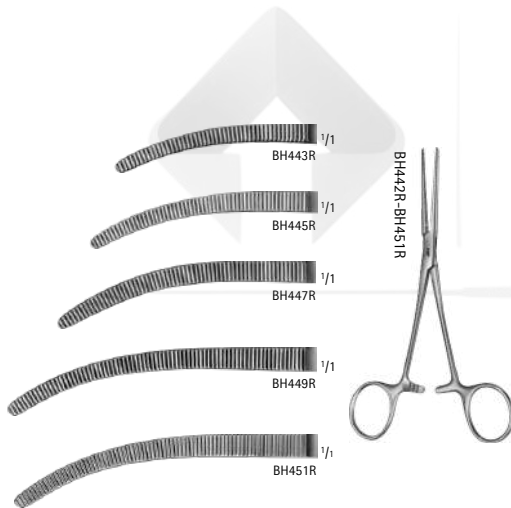

BH442R-BH451R



BH442R



BH444R



BH446R



BH448R



BH450R

ROCHESTER-PEAN FORCEPS

Catalog Number	Jaw	Length (in.)
BH442R	STR	6 1/4
BH444R	STR	7 1/4
BH446R	STR	7 7/8
BH448R	STR	8 7/8
BH450R	STR	9 1/2
BH443R	CVD	6 1/4
BH445R	CVD	7 1/4
BH447R	CVD	7 7/8
BH449R	CVD	8 7/8
BH451R	CVD	9 1/2

PEAN FORCEPS, LONG

Catalog Number	Jaw	Length (in.)
BH470R	STR	9 1/2
BH472R	STR	10 1/4
BH474R	STR	11
MB128R	STR	12
BH471R	CVD	9 1/2
BH473R	CVD	10 1/4
BH475R	CVD	11

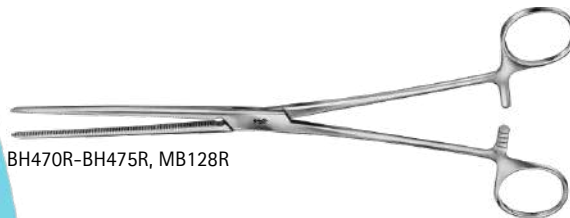

BH470R-BH475R, MB128R



BH471R



BH473R



BH475R



BH470R



BH472R



BH474R



MB128R

GENERAL SURGERY

Hemostatic Forceps and Clamps

KOCHER FORCEPS

Catalog Number	Jaw	Teeth	Length (in.)
BH630R	STR	1 x 2	6
BH631R	CVD	1 x 2	6



KOCHER FORCEPS, DELICATE

Catalog Number	Jaw	Teeth	Length (in.)
BH614R	STR	1 x 2	5 1/2
BH615R	CVD	1 x 2	5 1/2

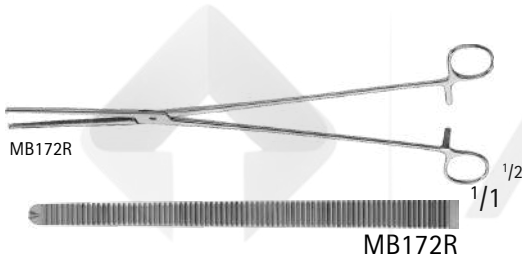
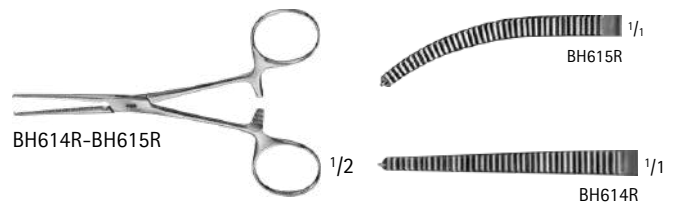

ROCHESTER-OCHSNER ARTERY FORCEPS

Catalog Number	Jaw	Teeth	Length (in.)
MB172R	STR	1 x 2	14

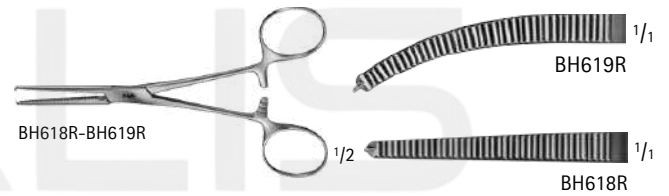

ROCHESTER-OCHSNER FORCEPS

Catalog Number	Jaw	Teeth	Length (in.)
BH618R	STR	1 x 2	5 1/2
BH619R	CVD	1 x 2	5 1/2

KOCHER-OCHSNER FORCEPS

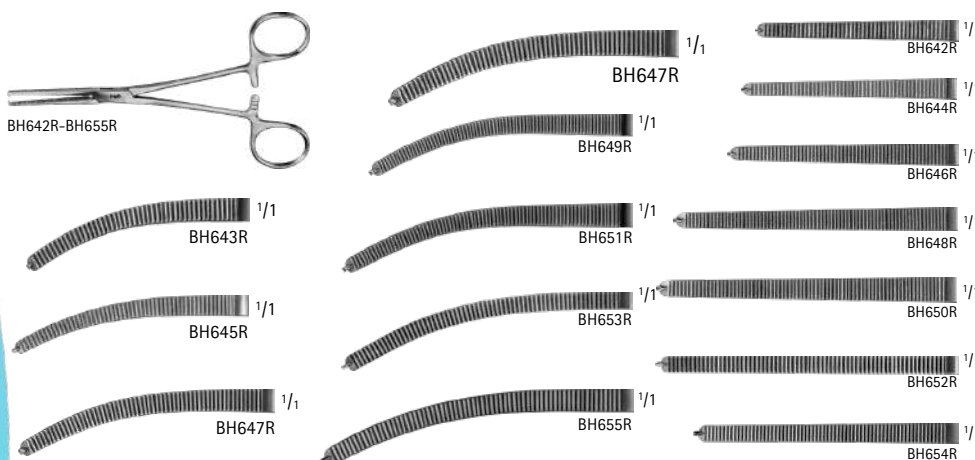

Catalog Number	Jaw	Teeth	Length (in.)
BH642R	STR	1 x 2	6 1/4
BH644R	STR	1 x 2	7 1/4
BH646R	STR	1 x 2	7 7/8
BH648R	STR	1 x 2	8 7/8
BH650R	STR	1 x 2	9 1/2
BH652R	STR	1 x 2	10 1/4
BH654R	STR	1 x 2	11
BH643R	CVD	1 x 2	6 1/4
BH645R	CVD	1 x 2	7 1/4
BH647R	CVD	1 x 2	7 7/8
BH649R	CVD	1 x 2	8 7/8
BH651R	CVD	1 x 2	9 1/2
BH653R	CVD	1 x 2	10 1/4
BH655R	CVD	1 x 2	11

GENERAL SURGERY

Hemostatic Forceps and Clamps

ROCHESTER-OCHSNER FORCEPS

Catalog Number	Jaw	Teeth	Length (in.)
MB807R	STR	1 x 2	14
MB909R	STR	1 x 2	16
MB908R	CVD	1 x 2	13 3/4



ROCHESTER-CARMALT FORCEPS

Catalog Number	Jaw	Length (in.)
BH800R	STR	6 1/4
BH804R	STR	7 7/8
MG196R	STR	9
MG431R	STR	10 1/4
BH801R	CVD	6 1/4
BH805R	CVD	7 7/8
MG197R	CVD	9
MG432R	CVD	10 1/4

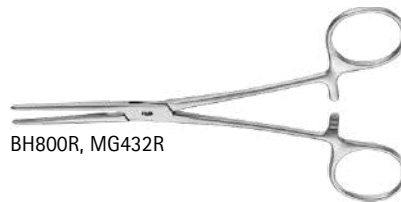

STOREY FORCEPS

Catalog Number	Tip	Length (in.)
MG353R	STRONG-CVD	8 3/4
MG354R	RIGHT-ANG	8 3/4



JONES HEMOSTATIC FORCEPS

Catalog Number	Jaw	Length (in.)
MG426R	STR	5



NEGUS TONSIL FORCEPS

Catalog Number	Jaw	Length (in.)
BH951R	HEAVY-CVD	7 1/2
BH952R	U-CVD	7 1/2

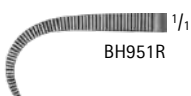
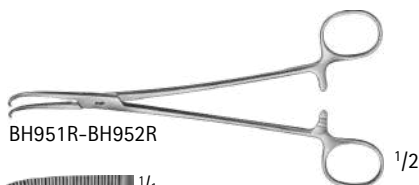

MOYNIHAN FORCEPS

Catalog Number	Jaw	Length (in.)
BH831R	CVD	9
BH833R	CVD	9 1/2

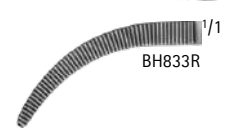
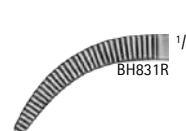
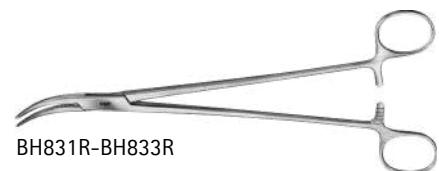

Hemostatic Forceps and Clamps

SCHNIDT TONSIL CLAMP

Catalog Number	Ring Handle	Jaw	Length (in.)
MA172R	OPEN RING	STR7	1/2
BH961R	OPEN-RINGS	LIGHT-CVD	7 1/4
BH963R	OPEN-RING	CVD	7 1/4
BH957R	CLOSED-RINGS	LIGHT-CVD7	1/4
BH959R	CLOSED-RING	CVD7	1/4

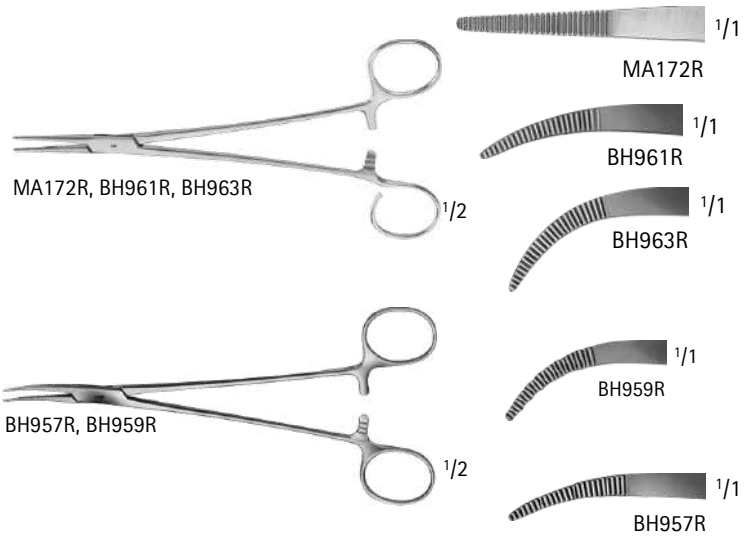

CARMALT ARTERY FORCEPS, LONGITUDINAL SERRATIONS

Catalog Number	Jaw	Length (in.)
MB182R	SLIGHT-CVD	12



MICRO HALSTED MOSQUITO FORCEPS, DELICATE

Catalog Number	Jaw	Teeth	Length (in.)
BH108R	STR	-	5
BH118R	STR	1 x 2	5
BH109R	CVD	-	5
BH119R	CVD	1 x 2	5

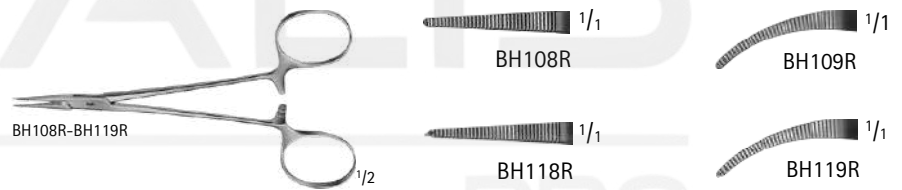

OCHSNER-DIXON ARTERY FORCEPS

Catalog Number	Jaw	Teeth	Length (in.)
MD450	STR	1 x 2	6 1/4

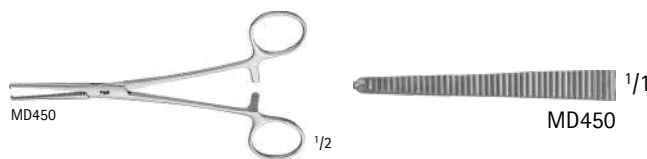

JACOBSON MOSQUITO FORCEPS

Catalog Number	Jaw	Length (in.)
BH106R	STR	5 1/8
MB229R	CVD	5

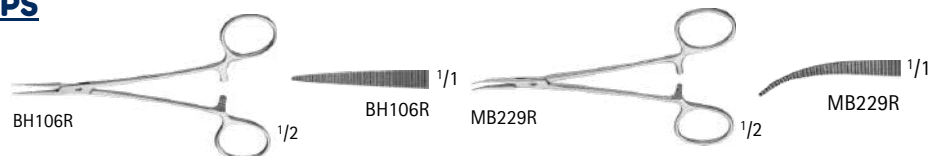

BABY HARTMANN MOSQUITO ARTERY FORCEPS

Catalog Number	Jaw	Teeth	Length (in.)
BH104R	STR	-	4
BH114R	STR	1 x 2	4
BH105R	CVD	-	4
BH115R	CVD	1 x 2	4

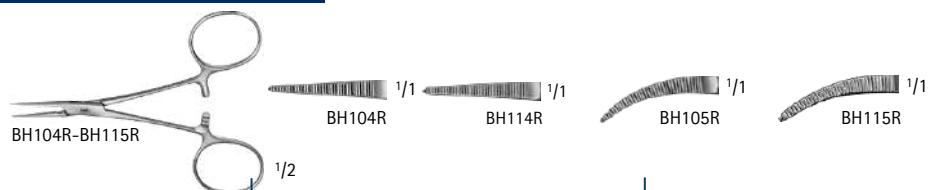

Hemostatic Forceps and Clamps

HALSTED MOSQUITO FORCEPS, DELICATE

Catalog Number	Jaw	Teeth	Length (in.)
BH110R	STR	-	5
BH120R	STR	1 x 2	5
BH210R	STR	-	7 7/8
BH214R	STR	1 x 2	7 7/8
BH111R	CVD	-	5
BH121R	CVD	1 x 2	5
BH211R	CVD	-	7 7/8
BH215R	CVD	1 x 2	7 7/8

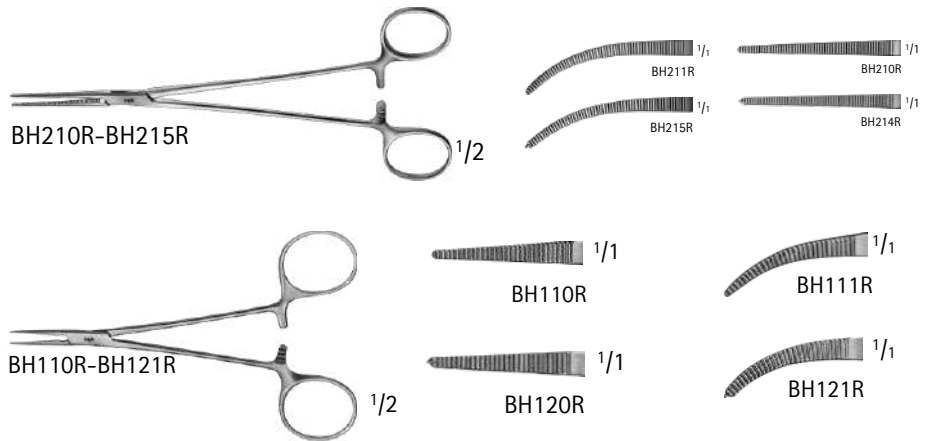

MOSQUITO FORCEPS

Catalog Number	Jaw	Length (in.)
MG085R	DEL, CVD.	6



ADSON HEMOSTATIC FORCEPS

Catalog Number	Jaw	Length (in.)
BH205R	CVD	8 1/2

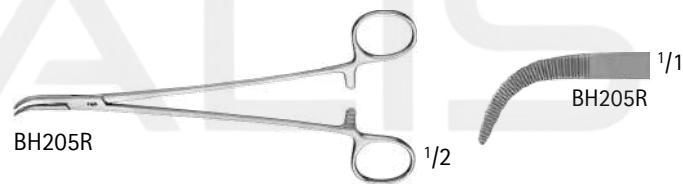

SUTURE FORCEPS

Catalog Number	Tip	Jaw	Length (in.)
BJ002R	SMOOTH	STR	3 3/4

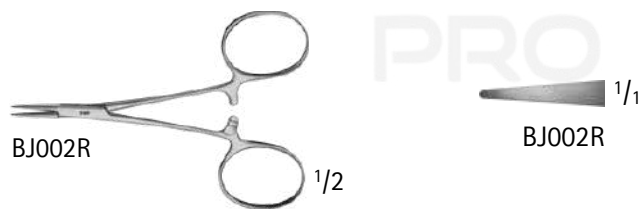

JACOBSON HEMOSTATIC FORCEPS

Catalog Number	Jaw	Length (in.)
BH187R	SLIGHT-CVD	7 1/2
BH189R	HEAVY-CVD	7 1/2

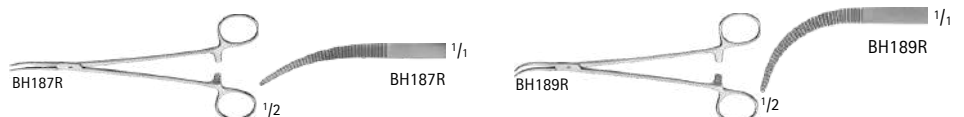

PROVIDENCE HOSPITAL FORCEPS, DELICATE

Catalog Number	Jaw	Length (in.)
BH130R	STR	5 1/2
BH131R	CVD	5 1/2

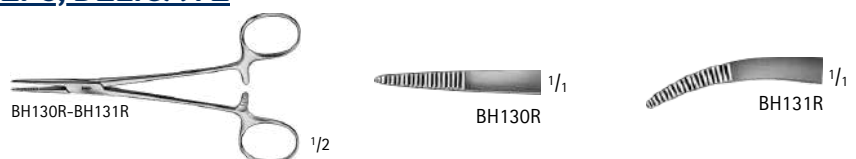

Hemostatic Forceps and Clamps

KELLY FORCEPS

Catalog Number	Jaw	Length (in.)
BH134R	STR	5 1/2
BH135R	CVD	5 1/2

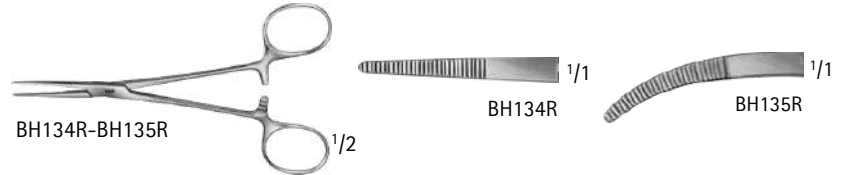

HALSTED FORCEPS DELICATE

Catalog Number	Jaw	Teeth	Length (in.)
BH202R	STR	-	7 1/4
BH212R	STR	1 x 2	7 1/4
BH203R	CVD	-	7 1/4
BH213R	CVD	1 x 2	7 1/4



CRILE FORCEPS

Catalog Number	Jaw	Teeth	Length (in.)
BH144R	STR	-	5 1/2
BH154R	STR	1 x 2	5 1/2
BH166R	STR	-	6 1/4
BH176R	STR	1 x 2	6 1/4
BH145R	CVD	-	5 1/2
BH155R	CVD	1 x 2	5 1/2
BH167R	CVD	-	6 1/4
BH177R	CVD	1 x 2	6 1/4

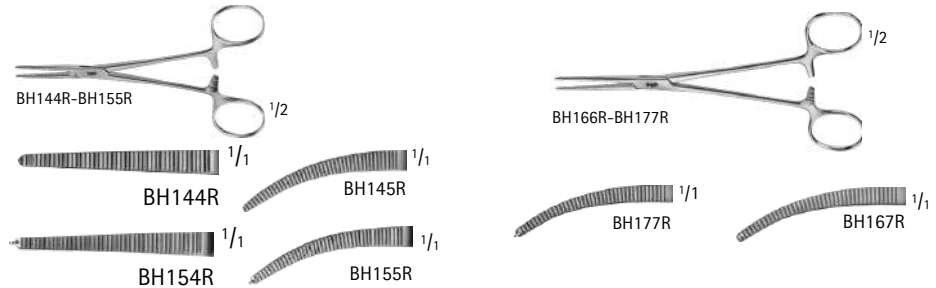

BABY CRILE FORCEPS

Catalog Number	Jaw	Teeth	Length (in.)
BH140R	STR	-	5 1/2
BH150R	STR	1 x 2	5 1/2
BH141R	CVD	-	5 1/2
BH151R	CVD	1 x 2	5 1/2

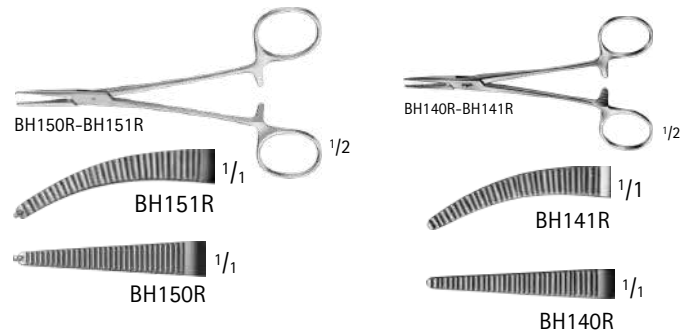

LERICHE FORCEPS, DELICATE

Catalog Number	Jaw	Teeth	Length (in.)
BH160R	STR	-	6
BH170R	STR	1 x 2	6
BH161R	CVD	-	6
BH171R	CVD	1 x 2	6

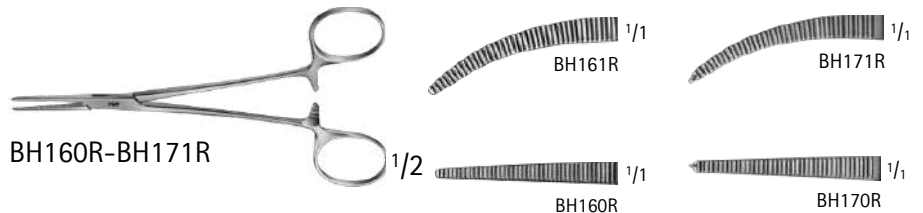

GENERAL SURGERY

Hemostatic Forceps and Clamps

COLLER ARTERY FORCEPS

Catalog Number	Jaw	Length (in.)
MD464	STR	5 3/4
MD466R	STR	6 1/2
MD468	STR	7
MD465R	CVD	5 3/4
MD467R	CVD	6 1/2
MD469	CVD	7

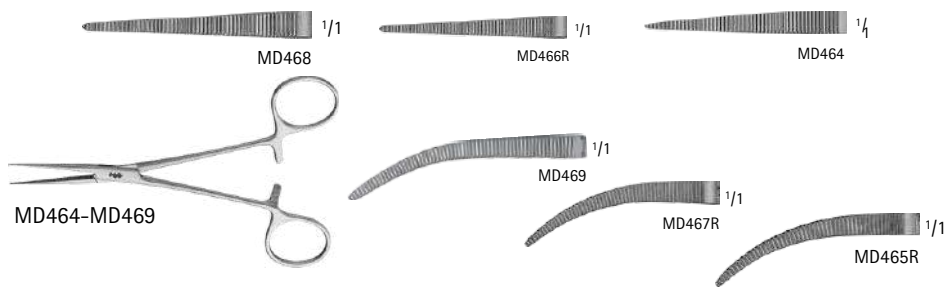

NISSEN Tonsil Forceps, Delicate

Catalog Number	Jaw	Length (in.)
BH199R	CVD	7 1/4

BIRKETT HEMOSTATIC FORCEPS

Catalog Number	Jaw	Length (in.)
BH197R	CVD	7 1/4

RANKIN FORCEPS, DELICATE

Catalog Number	Jaw	Length (in.)
BH164R	STR	6 1/4
BH165R	CVD	6 1/4



HEISS FORCEPS, DELICATE

Catalog Number	Jaw	Teeth	Length (in.)
BH206R	STR	-	7 7/8
BH216R	STR	1 x 2	7 7/8
BH207R	CVD	-	7 7/8
BH217R	CVD	1 x 2	7 7/8
BH209R	HVY-CVD	-	7 3/4

ADSON TONSIL FORCEPS, DELICATE

Catalog Number	Jaw	Length (in.)
BH200R	STR	7 1/4
BH201R	CVD	7 1/4

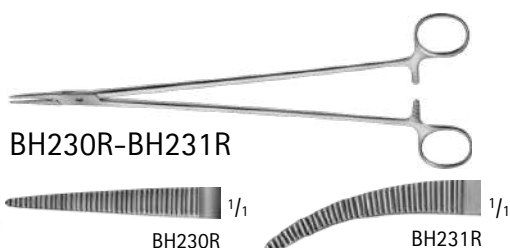

BRIDGE FORCEPS, DELICATE

Catalog Number	Jaw	Length (in.)
BH230R	STR	10 3/4
BH231R	CVD	10 3/4

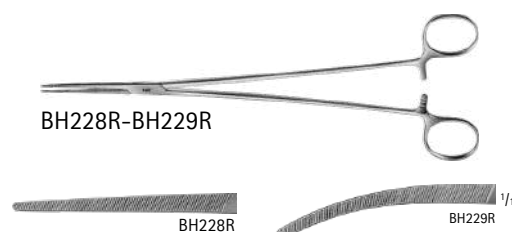

BRIDGE FORCEPS, DELICATE

Catalog Number	Jaw	Length (in.)
BH228R	STR	9 5/8
BH229R	CVD	9 5/8

GENERAL SURGERY

Dissecting and Right Angle Forceps

HOLLE FORCEPS, DELICATE

Catalog Number	Length (in.)
BJ037R	5 3/4
BJ038R	7 1/4
BJ039R	9 1/4

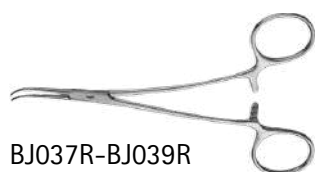

BJ037R-BJ039R



BJ039R



BJ038R



BJ037R

GEMINI RIGHT ANGLE FORCEPS

Catalog Number	Length (in.)
BJ100R	5 1/2
BJ102R	7
BJ103R	7 7/8
BJ104R	9
BJ106R	11

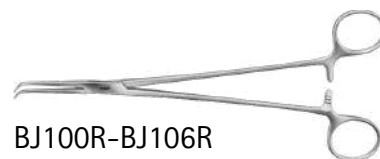

BJ100R-BJ106R



BJ103R



BJ106R

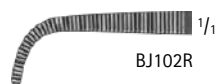

BJ102R



BJ104R



BJ100R

KANTROWITZ RIGHT ANGLE FORCEPS

Catalog Number	Length (in.)
MB058R	6 3/8
BJ057R	7 7/8
BJ058R	9 5/8
BJ059R	10 3/4
MB061R	12



MB061R



MB061R



BJ057R-BJ059R



BJ058R



BJ059R



BJ057R



MB058R

KANTROWITZ RIGHT ANGLE FORCEPS

Catalog Number	Length (in.)
BJ008R	5 1/2



BJ008R

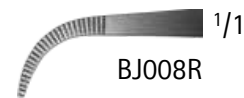

BJ008R

GENERAL SURGERY

Dissecting and Right Angle Forceps

BABY ADSON FORCEPS

Catalog Number	Length (in.)
BJ013R	5 1/2
BJ014R	7



OVERHOLT-GEISSENDOERFER FORCEPS

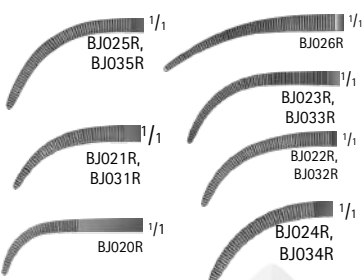

Catalog Number	Jaw Curve (#)	Length (in.)
BJ020R	0	7 3/4
BJ021R	1	8
BJ022R	2	8 3/4
BJ023R	3	8 7/8
BJ024R	4	8 3/4
BJ025R	5	9
BJ026R	6	8 7/8
BJ031R	1	10 1/4
BJ032R	2	10 5/8
BJ033R	3	10 3/4
BJ034R	4	10 5/8
BJ035R	5	11



MIXTER (MEEKER) RIGHT ANGLE FORCEPS

Catalog Number	Length (in.)
MD569	5 1/2
MD570R	7

OVERHOLT FORCEPS

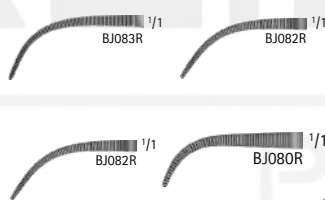

Catalog Number	Jaw Curve (#)	Length (in.)
BJ080R	0	8 1/2
BJ081R	1	8 1/4
BJ082R	2	8 3/4
BJ083R	3	8 7/8
BJ086R	6	8 7/8
BJ090R	0	11 5/8
BJ091R	1	11 5/8
BJ096R	6	11 3/4

MEEKER FORCEPS

Catalog Number	Length (in.)
MB459R	11

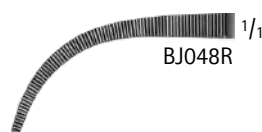
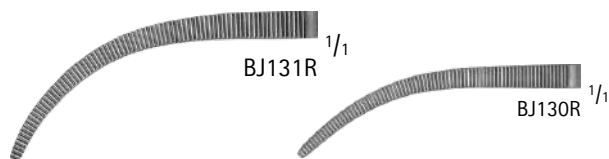
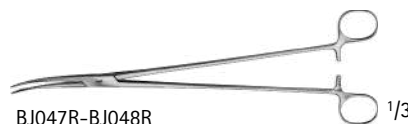
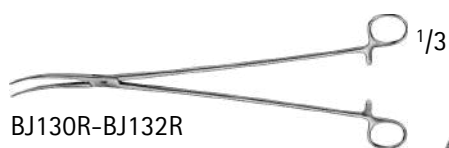

ZENKER LIGATURE FORCEPS

Catalog Number	Jaw	Length (in.)
BJ047R	SLIGHT-CVD	11 3/4
BJ048R	HEAVY-CVD	11 1/2
BJ130R	SLIGHT-CVD	13 3/4
BJ131R	CVD	13 3/4
BJ132R	HEAVY-CVD	13 3/4

GENERAL SURGERY

Dissecting and Right Angle Forceps



FINOCHIETTO FORCEPS

Catalog Number	Length (in.)
BJ052R	9 5/8



MIXTER-O'SHAUGNESSY FORCEPS

Catalog Number	Length (in.)
BJ050R	7 1/2

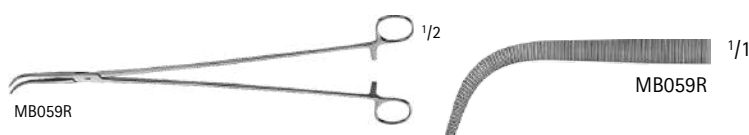

MIXTER THORACIC FORCEPS

Catalog Number	Length (in.)
MB059R	14



LAHEY FORCEPS

Catalog Number	Length (in.)
BJ060R	8 7/8

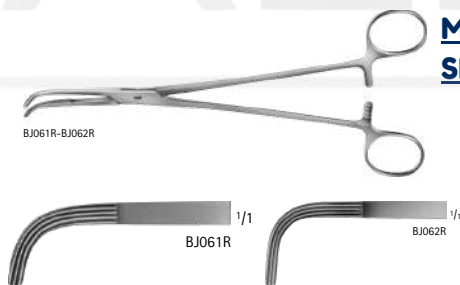
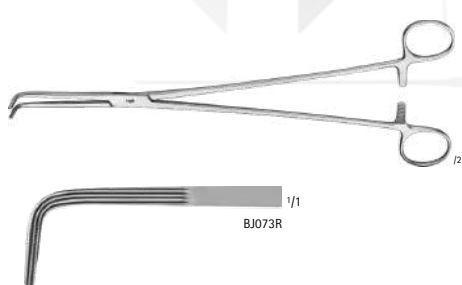

MIXTER FORCEPS, LONGITUDINAL SERRATIONS

Catalog Number	Length (in.)
BJ061R	8 3/4
BJ062R	9 3/4
BJ073R	11 1/2

HARRINGTON-MIXTER FORCEPS, LONGITUDINAL SERRATIONS

Catalog Number	Length (in.)
BJ072R	12 1/2

BABY MIXTER FORCEPS

Catalog Number	Length (in.)
BJ011R	5 1/2
BJ012R	7

MIXTER FORCEPS

GENERAL SURGERY

Dissecting and Right Angle Forceps



REINHOFF SWAN NECK CLAMP

Catalog Number	Tip	Jaw	Handle	Length (in.)
US116	SERR	CVD	CVD	10 1/4



LAWRENCE FORCEPS

Catalog Number	Length (in.)
BJ070R	10 5/8



WIKSTROEM FORCEPS

Catalog Number	Length (in.)
BJ051R	8



DEBAKEY-COLLIER FORCEPS

Catalog Number	Jaw	Length (in.)
MB899R	CVD, SERR	8



COLLIER-ANDERSON FORCEPS

	Length (in.)
CVD, LONGITUDINAL SERR	10
CVD, LONGITUDINAL SERR	11



KIEBACK FORCEPS

	Jaw	Length (in.)
	CVD, LONGITUDINAL SERR	9 1/4

GENERAL SURGERY

Towel and Tubing Clamps

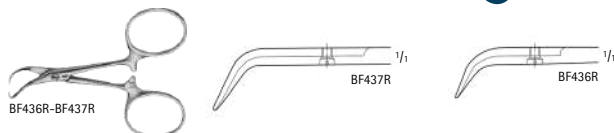

BACKHAUS TOWEL CLAMP, W/ SCREW

Catalog Number	Length (in.)
BF436R	3 1/8
BF437R	4 1/8



BERNHARD TOWEL CLAMP

Catalog Number	Length (in.)
BF426R	6 1/4

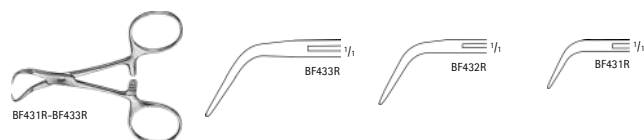

BACKHAUS TOWEL CLAMP

Catalog Number	Length (in.)
BF431R	3 1/2
BF432R	4 1/4
BF433R	5 1/4



JONES TOWEL CLAMP

Catalog Number	Length (in.)
BF407R	3 1/4

GENERAL SURGERY

Towel and Tubing Clamps

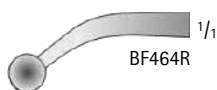

TOWEL CLAMP, PAPER DRAPE

Catalog Number	Length (in.)
BF464R	5 1/2
BF460R	6

ROEDER TOWEL CLAMP, W/ BALL ON JAWS

Catalog Number	Length (in.)
BF448R	5 1/4

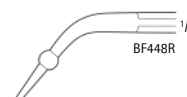

BACKHAUS-KOCHER TOWEL CLAMP, W/ SCREW

Catalog Number	Length (in.)
BF444R	5 1/4



NON-PERFORATING TOWEL FORCEPS

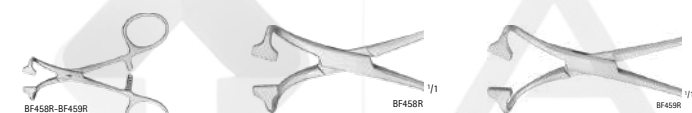

Catalog Number	Length (in.)
BF458R	4
BF459R	5 1/2



LORNA NON-PERFORATING TOWEL CLAMP



Catalog Number	Length (in.)
BF461R	3 3/4
BF463R	5 1/8

TUBING CLAMP, W/ GUARD



Catalog Number	Jaw	Length (in.)
MD652	SERR	6
MD653	SERR	7
MD654	SERR	7 7/8

Skin Hooks

Dimensions for blade size of retractors

1st number = depth Example: 25 x 38 mm

2nd number = width

JOSEPH SKIN HOOK

Catalog Number	Tip	Prongs	Tip Size (mm)	Length (in.)
OL620R	SHARP	1	-	6 1/2
MA185R	SHARP	2	2	6 1/4
OL622R	SHARP	2	3	6 1/2
OL623R	SHARP	2	6	6 1/2
OL624R	SHARP	2	8	6 1/2
MD581	SHARP	2	10	6 1/2

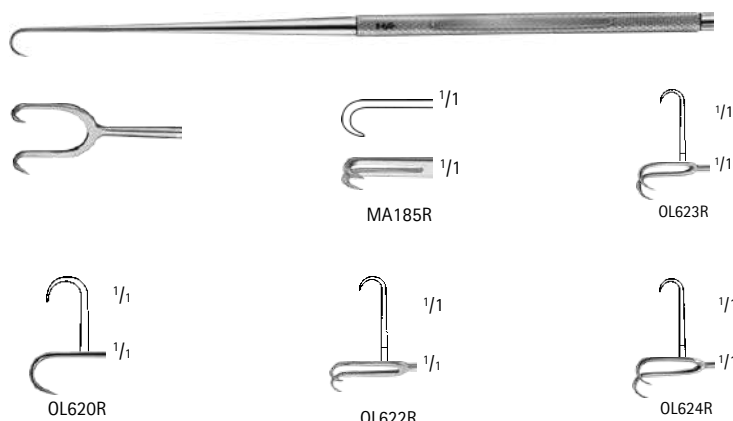

GUTHRIE DOUBLE HOOK

Catalog Number	Tip	Length (in.)
OA334R	SHARP	5
OA335R	SHARP	5 1/8

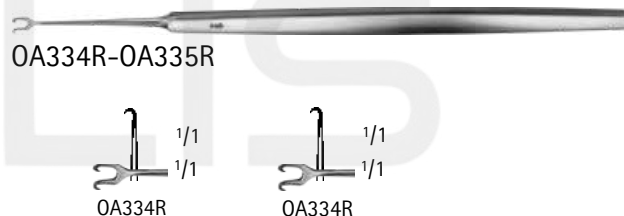

GRAEFE HOOK

Catalog Number	Tip	Length (in.)
OA332R	SHARP	5
OA333R	BLUNT	5



FREER DOUBLE HOOK

Catalog Number	Tip	Tip Size (mm)	Length (in.)
OL621R	SHARP	2.0 x 3.2	6

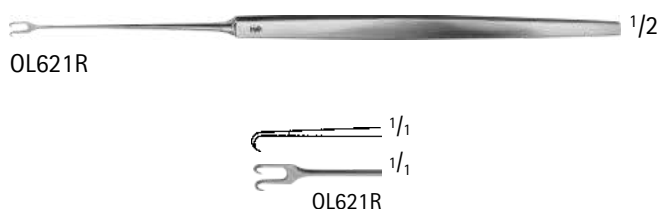

Skin Hooks

MCINDOE HOOK

Catalog Number	Tip	Blade End	Tip Size (mm)	Length (in.)
OL615R	SHARP	2 PRONGS	9	6

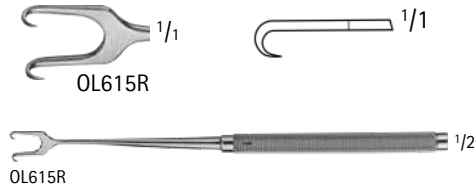

ROLLET HOOK RETRACTOR

Catalog Number	Tip	Blade End	Tip Size (mm)	Length (in.)
OA336R	SHARP	2 PRONGS	2.2 x 4.5	5 1/8
OA337R	SHARP	4 PRONGS	2.5 x 7.0	5 1/4
OA338R	BLUNT	4 PRONGS	2.2 x 7.0	5 1/4

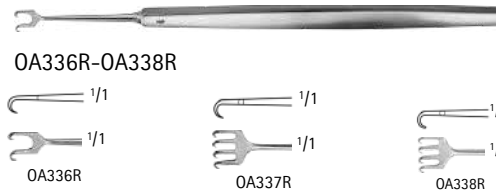

PAUL TENDON HOOK

Catalog Number	Tip	Blade End	Tip Size (mm)	Length (in.)
OA340R	BLUNT	3 PRONGS	11 x 8	4 3/4



JAEGER HOOK RETRACTOR, FINE

Catalog Number	Tip	Length (in.)
OA351R	SHARP	5 1/4



KILNER SKIN HOOK

Catalog Number	Tip	Length (in.)
OL610R	SHARP	6 1/4

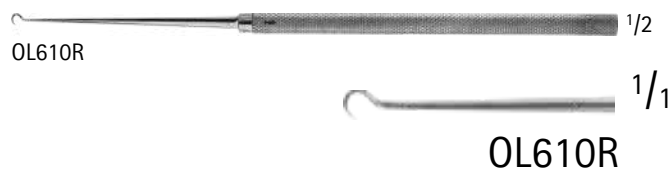

GILLIES SKIN HOOK

Catalog Number	Tip	Hook End	Length (in.)
OL611R	SHARP	SMALL	7
OL612R	SHARP	LARGE	7



Skin Hooks

COTTLE HOOK

Catalog Number	Tip	Hook End	Length (in.)
OL617R	SHARP	ANG	6 1/4
OL619R	SHARP	HVY-CVD	6 1/4



KLEINERT-KUTZ SKIN HOOK

Catalog Number	Size	Tip	Tip Size (mm)	Length (in.)
OL601R	1	SHARP	2.5	6 1/4
OL602R	2	SHARP	4.2	6 1/4
OL603R	3	SHARP	4.8	6 1/4



PRONG MICRO HOOKS

Catalog Number	Tip	Tip Size (mm)	Length (in.)
MB885R	SHARP	1	5 5/8
MB886R	SHARP	2	5 5/8
MB887R	BLUNT	2	5 5/8
MB888R	SHARP	2	5 5/8
MB889R	SHARP	5	5 5/8
MB890R	SHARP	7	5 5/8
MB891R	SHARP	10	5 5/8



Hook Retractors

BROM VEIN HOOK



Catalog Number	Length (in.)
BT075R	6 3/4

BERGMANN HOOK



Catalog Number	Tip	Tip Size (mm)	Length (in.)
BT100R	SHARP	7	5 1/2

EMMET FISTULA HOOK



Catalog Number	Tip	Length (in.)
BT161R	SHARP	8 3/4

SIMON FISTULA HOOK

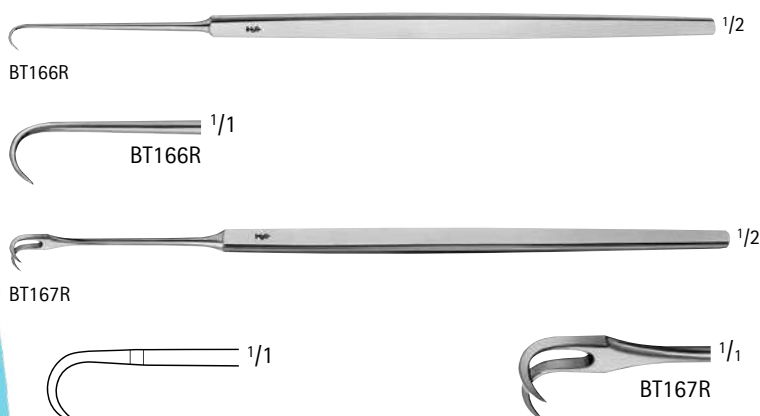

Catalog Number	Tip	Blade End	Length (in.)
BT166R	SHARP	1 PRONG	8 3/4
BT167R	SHARP	2 PRONGS	8 3/4

GENERAL SURGERY

Hand Held Retractors

BABY SENN-MILLER RETRACTOR, FLAT HANDLE

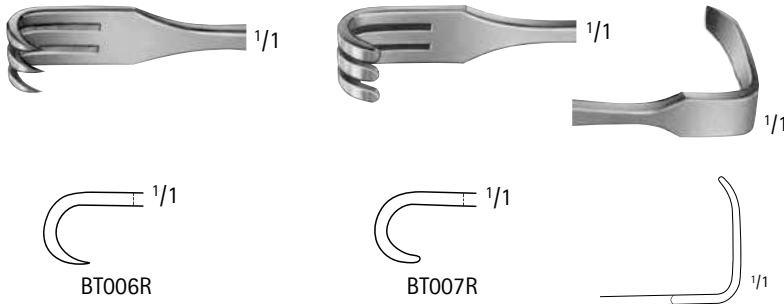

Catalog Number	Tip	Blade End	Blade Size (mm)	Length (in.)
BT006R	SHARP	3 PRONGS	8 x 7 / 22 x 7	6 1/8
BT007R	BLUNT	3 PRONGS	8 x 7 / 22 x 7	6 1/8

SENN-MILLER RETRACTOR

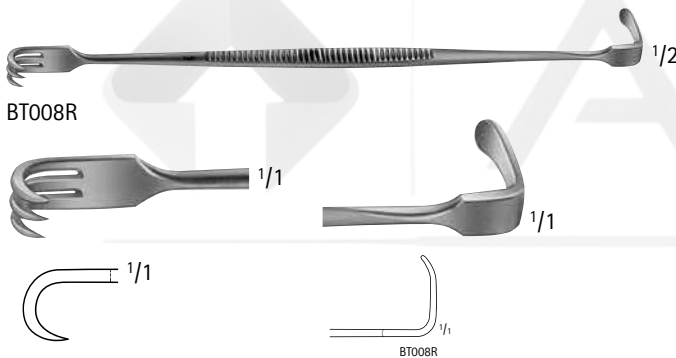

Catalog Number	Tip	Blade End	Blade Size (mm)	Length (in.)
BT008R	SHARP	3 PRONGS	8 x 7 / 18 x 5.5	6 1/2

SENN RETRACTOR, ROUND TAPERED HANDLE

LENGTH (IN.)

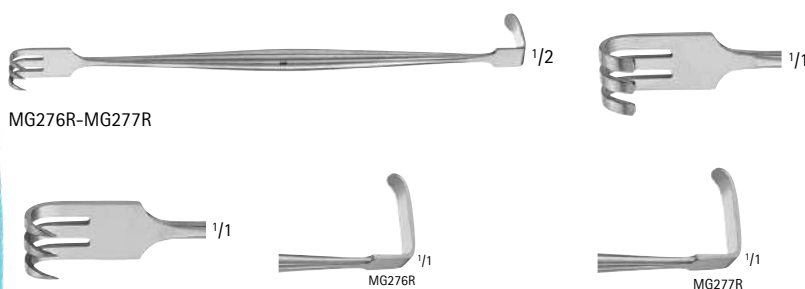

Catalog Number	Tip	Blade End	Blade Size (mm)	Length (in.)
MG276R	SHARP	3 PRONGS	9 x 10 / 22 x 7	6 1/4
MG277R	BLUNT	3 PRONGS	9 x 10 / 22 x 7	6 1/4

GENERAL SURGERY

Hand Held Retractors

RAGNELL RETRACTOR

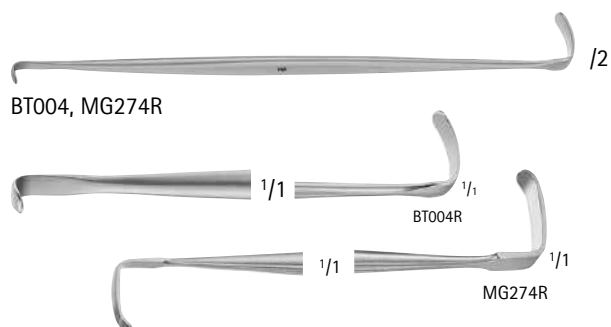

Catalog Number	Blade Size (mm)	Length (in.)
BT004R	3 x 5 / 6.3 x 14	6
MG274R	3 x 11 / 5.4 x 17	6

DAVIS DOUBLE ENDED RETRACTOR

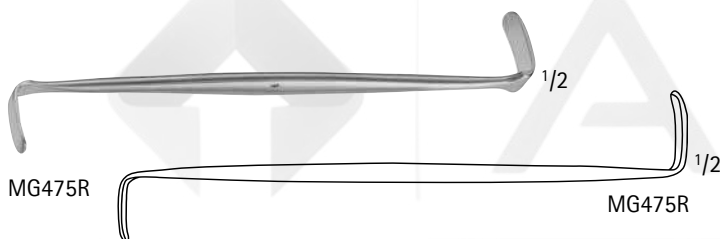

Catalog Number	Blade Size (mm)	Length (in.)
MG475R	19 x 9 / 23 x 6.4	6

DOUBLE ENDED RETRACTOR



Catalog Number	Blade Size (mm)	Length (in.)
BT187R	20 x 15 / 20 x 19	8

GOELET RETRACTOR



Catalog Number	Blade Size (mm)	Length (in.)
MD497	30 x 32 / 35 x 40	7 1/2

GENERAL SURGERY

Hand Held Retractors

LUER RETRACTOR

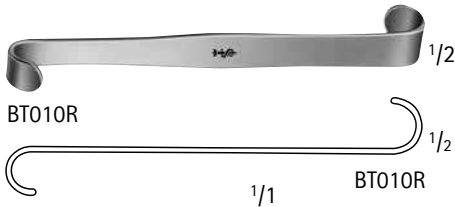

Catalog Number	Blade Size (mm)	Length (in.)
BT010R	10 x 8 / 12 x 11	4 1/4

FARABEUF RETRACTOR, 2/SET

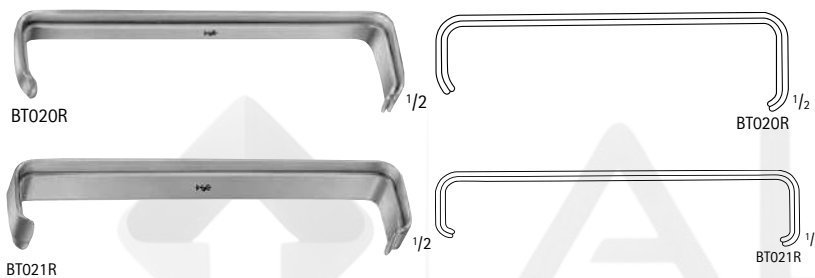

Catalog Number	Blade Size (mm)	Length (in.)
BT020R	25 x 10 / 32 x 12 22 x 10 / 29 x 12	5
BT021R	23 x 16 / 28 x 16 19 x 16 / 24 x 16	6

MAYO-COLLINS RETRACTOR, 2/SET



Catalog Number	Blade Size (mm)	Length (in.)
MB984R	31 x 20 / 30 x 18 28 x 19 / 26 x 17	5 7/8

COLLIN RETRACTOR, 2/SET



Catalog Number	Blade Size (mm)	Length (in.)
BT022R	21 x 14 / 32 x 16 17 x 14 / 28 x 16	6

GENERAL SURGERY

Hand Held Retractors

CRILE RETRACTOR

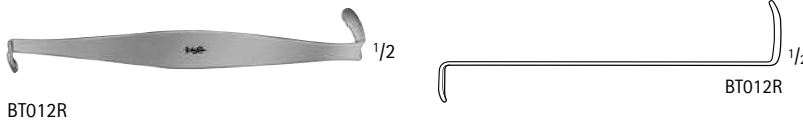

Catalog Number	Blade Size (mm)	Length (in.)
BT012R	11 x 4 / 19 x 6	4 1/4

CRILE RETRACTOR

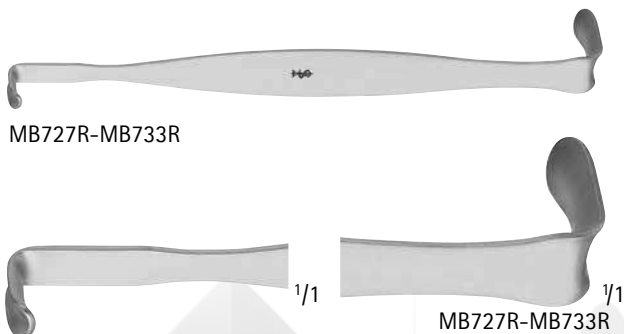

Catalog Number	Size	Blade Size (mm)	Length (in.)
MB727R	1	3 x 11 / 6 x 21	4 1/4
MB728R	2	6 x 13 / 10 x 21	6 1/8
MB729R	3	16 x 25 / 17 x 35	6 1/4
MB730R	4	22 x 29 / 29 x 44	7
MB731R	5	29 x 41 / 35 x 51	7
MB732R	6	32 x 64 / 35 x 70	7 7/8
MB733R	7	41 x 76 / 51 x 79	8 7/8

ROSE TRACHEAL RETRACTOR

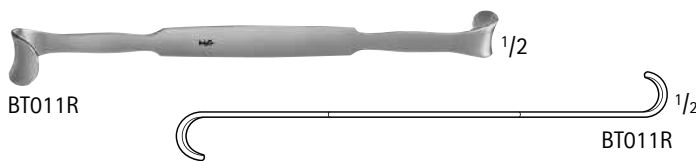

Catalog Number	Blade Size (mm)	Length (in.)
BT011R	10 x 12 / 11 x 15	5 1/8

COLLIN RETRACTOR, 2/SET



Catalog Number	Blade Size (mm)	Length (in.)
MG474R	11 x 22 / 14 x 35	4 1/2

GENERAL SURGERY

Hand Held Retractors

PARKER RETRACTOR, 2/SET

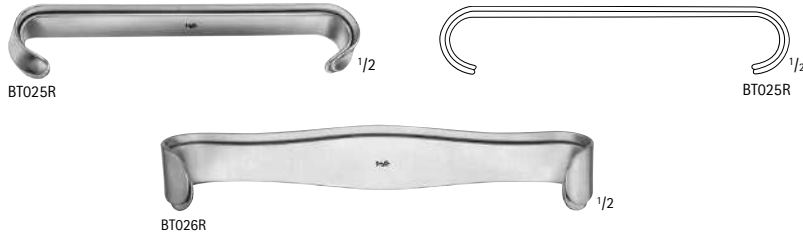

Catalog Number	Blade Size (mm)	Length (in.)
BT025R	22 x 15 / 22 x 15 18 x 15 / 18 x 15	5 1/4
BT026R	31 x 25 / 27 x 25 31 x 25 / 27 x 25	7

ROUX RETRACTOR



Catalog Number	Blade Size (mm)	Length (in.)
BT034R	20 x 22 / 25 x 29	6
BT035R	25 x 26 / 30 x 38	6 1/4
BT036R	28 x 29 / 33 x 44	6 3/4

ROUX RETRACTOR

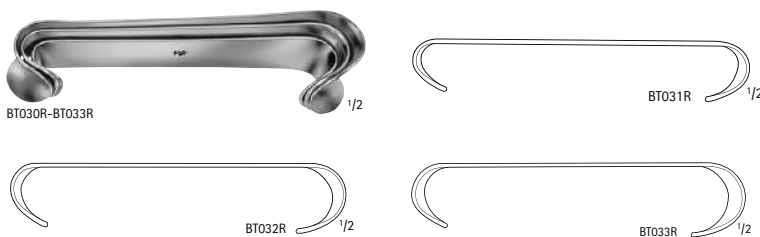

Catalog Number	Blade Size (mm)	Length (in.)
BT030R	COMPLETE SET BT031R-BT033R	-
BT031R	21 x 22 / 27 x 28	5 3/4
BT032R	26 x 26 / 32 x 26	6 1/8
BT033R	30 x 30 / 36 x 44	6 1/2

ROUX RETRACTOR

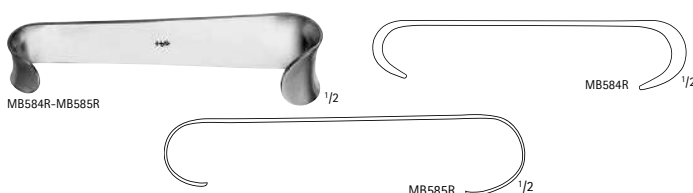

Catalog Number	Blade Size (mm)	Length (in.)
MB584R	25 x 26 / 30 x 37	6 1/2
MB585R	28 x 28 / 29 x 40	6 1/2

GENERAL SURGERY

Hand Held Retractors

ROUX RETRACTOR, LONG



Catalog Number	Blade Size (mm)	Length (in.)
BT029R	28 x 28 / 46 x 28	7 1/2

MATHIEU RETRACTOR, 2/SET



Catalog Number	Blade Size (mm)	Length (in.)
BT040R	42 x 13 / 41 x 13 45 x 25 / 40 x 25	7 7/8

US ARMY RETRACTOR, 2/SET



Catalog Number	Blade Size (mm)	Length (in.)
BT041R	26 x 15 / 22 x 15 43 x 15 / 39 x 15	8 3/4

HOOK, SMALL CURVE

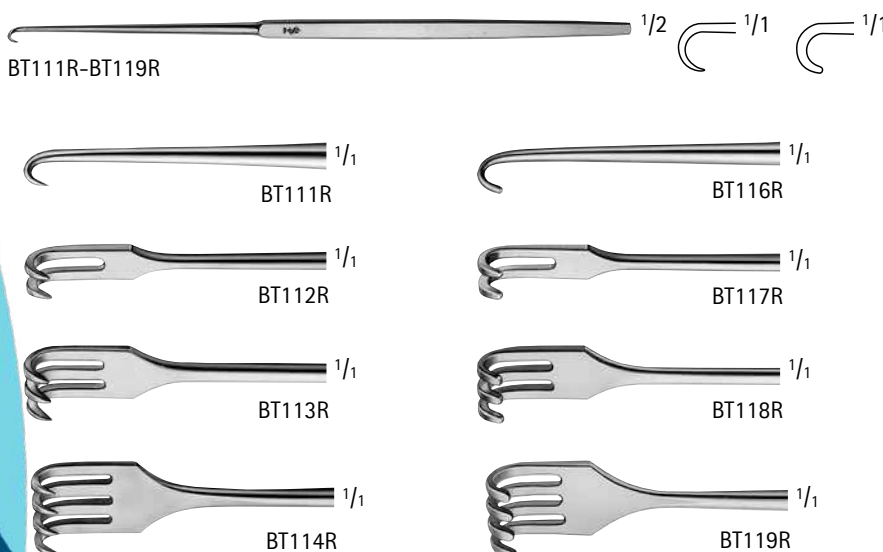

Catalog Number	Tip	Blade End	Blade Size mm)	Length (in.)
BT111R	SHARP	1 PRONG	-	6 1/2
BT112R	SHARP	2PRONGS	5.0 x 4.2	6 1/2
BT113R	SHARP	3PRONGS	5.0 x 7.0	6 1/2
BT114R	SHARP	4PRONGS	5.0 x 9.5	6 1/2
BT116R	BLUNT	1PRONG	-	6 1/2
BT117R	BLUNT	2PRONGS	4.5 x 4.2	6 1/2
BT118R	BLUNT	3PRONGS	4.5 x 7.0	6 1/2
BT119R	BLUNT	4PRONGS	4.5 x 9.0	6 1/2

GENERAL SURGERY

Hand Held Retractors

HOOK, LARGE CURVE

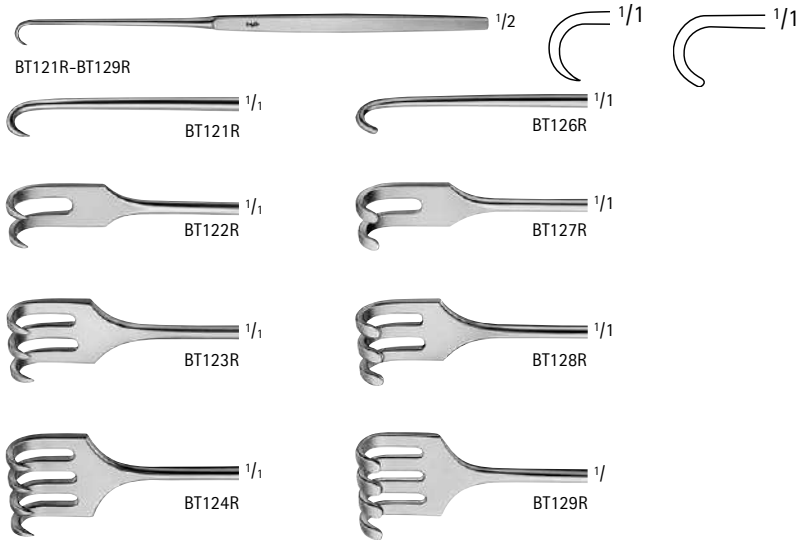

Catalog Number	Tip	Blade End	Blade Size (mm)	Length (in.)
BT121R	SHARP	1 PRONG	-	6 1/2
BT122R	SHARP	2PRONGS	7.5 x 7.5	6 1/2
BT123R	SHARP	3PRONGS	7.5 x 10.0	6 1/2
BT124R	SHARP	4PRONGS	7.5 x 14.0	6 1/2
BT126R	BLUNT	1PRONG	-	6 1/2
BT127R	BLUNT	2PRONGS	6.8 x 7.5	6 1/2
BT128R	BLUNT	3PRONGS	6.8 x 10.0	6 1/2
BT129R	BLUNT	4PRONGS	6.8 x 14.0	6 1/2

CRILE HOOK AND DISSECTOR

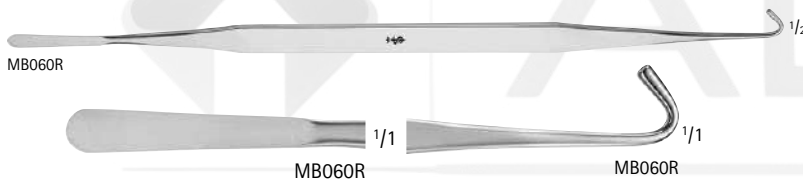

Catalog Number	Length (in.)
MB060R	11 3/4

KLAPP TENDON HOOK

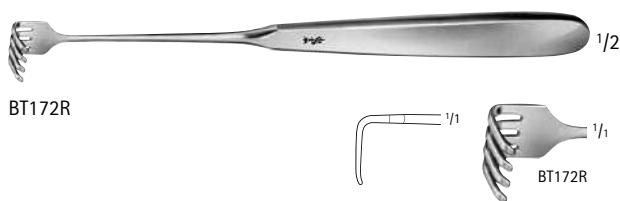

Catalog Number	Tip	Blade End	Blade Size (mm)	Length (in.)
BT172R	BLUNT	4 PRONGS	15 x 11	6 7/8

VEIN RETRACTOR



Catalog Number	Blade Size (mm)	Length (in.)
BT179R	10 x 13	6 1/4

GENERAL SURGERY

Hand Held Retractors

KOENIG VEIN RETRACTOR



Catalog Number	Blade Size (mm)	Length (in.)
BT182R	13 x 13	7
BT183R	12 x 16	7

MEYERDING THUMB RETRACTOR

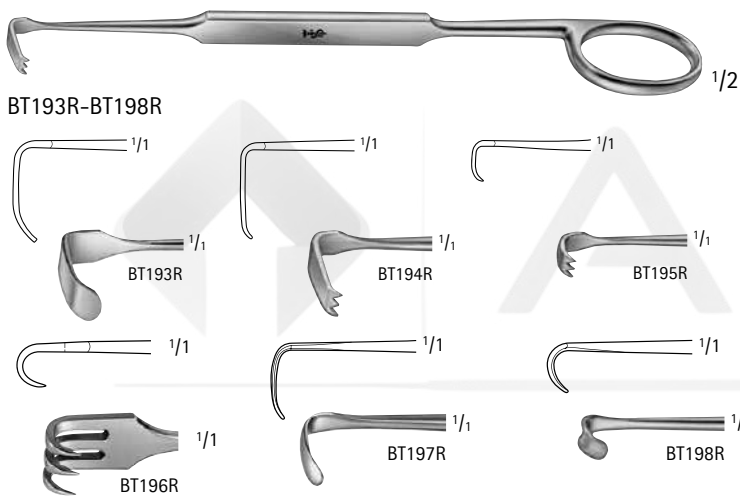

Catalog Number	Blade Size	Size (#)	Blade Size (mm)	Length (in.)
BT193R	A	1	18 x 7	7
BT194R	B	2	16 x 5	7
BT195R	C	3	7 x 4	7
BT196R	D	4	5 x 10	7
BT197R	E	5	11 x 4	7
BT198R	F	6	6 x 4	7

CUSHING-KOCHER RETRACTOR



Catalog Number	Blade Size (mm)	Length (in.)
BT190R	10 x 10	6 7/8

CUSHING VEIN RETRACTOR



Catalog Number	Blade Size (mm)	Length (in.)
BT184R	10 x 13	8
BT185R	14 x 18	8

GENERAL SURGERY

Hand Held Retractors

CUSHING VEIN RETRACTOR (CONTINUED)



Catalog Number	Blade Size (mm)	Length (in.)
BT200R	14 x 11	9 3/4
BT202R	22 x 15	9 3/4

CUSHING VEIN RETRACTOR



Catalog Number	Blade Size (mm)	Length (in.)
MB912R	14	12 1/2
MB913R	14	14
MB914R	14	16

GIL VERNET RETRACTOR, MALLEABLE



Catalog Number	Blade Size (mm)	Length (in.)
MB766R	9	11 1/4
MB767R	11	11 1/4
MB768R	13	11 1/4
MB769R	18	11 1/4

VOLKMANN RETRACTOR

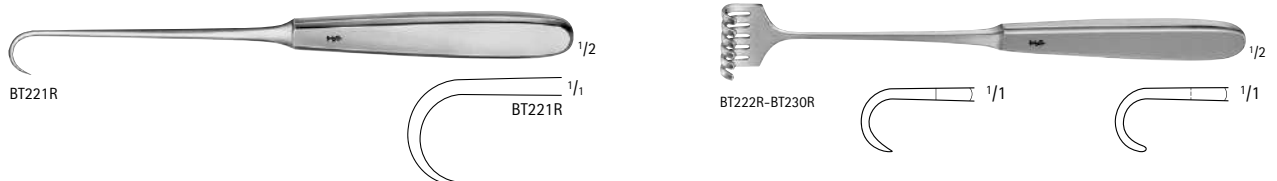

GENERAL SURGERY

Hand Held Retractors



VOLKMANN RETRACTOR, SMALL

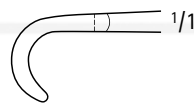
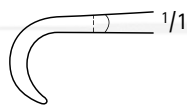
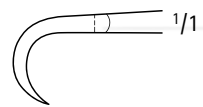
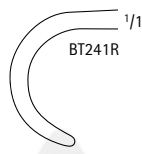
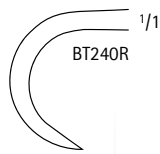

Catalog Number	Tip	Blade End	Blade Size (mm)	Length (in.)
BT240R	SHARP	1 PRONG	-	8 3/4
BT241R	BLUNT	1PRONG	-	8 3/4
BT242R	SHARP	2PRONGS	9 x 8	8 3/4
BT243R	SHARP	3PRONGS	9 x 13	8 3/4
BT244R	SHARP	4PRONGS	9 x 19	8 3/4
BT246R	SHARP	6PRONGS	9 x 29	8 3/4
BT248R	SHARP	8PRONGS	9 x 40	8 3/4
BT257R	SEMI-S	2PRONGS	8.5 x 8	8 3/4
BT259R	SEMI-S	3PRONGS	8.5 x 13	8 3/4
BT260R	SEMI-S	4PRONGS	8.5 x 19	8 3/4
BT261R	SEMI-S	6PRONGS	8.5 x 29	8 3/4
BT265R	SEMI-S	8PRONGS	8.5 x 40	8 3/4
BT252R	BLUNT	2PRONGS	8 x 8	8 3/4
BT253R	BLUNT	3PRONGS	8 x 13	8 3/4
BT254R	BLUNT	4PRONGS	8 x 19	8 3/4
BT256R	BLUNT	6PRONGS	8 x 29	8 3/4
BT258R	BLUNT	8PRONGS	8 x 40	8 3/4

GENERAL SURGERY

Hand Held Retractors

VOLKMANN RETRACTOR, US VERSION

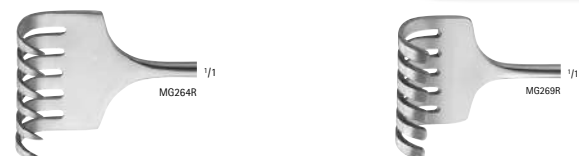

Catalog Number	Tip	Blade End	Blade Size (mm)	Length (in.)
MG260R	SHARP	2PRONGS	20 x 11	8 3/4
MG261R	SHARP	3PRONGS	20 x 18	8 3/4
MG262R	SHARP	4PRONGS	20 x 26	8 3/4
MG264R	SHARP	6PRONGS	20 x 40	8 3/4
MG265R	BLUNT	2PRONGS	20 x 11	8 3/4
MG266R	BLUNT	3PRONGS	20 x 18	8 3/4
MG267R	BLUNT	4PRONGS	20 x 26	8 3/4
MG269R	BLUNT	6PRONGS	20 x 40	8 3/4

GENERAL SURGERY

Hand Held Retractors

KOCHER RETRACTOR, LARGE

Catalog Number	Tip	Blade End	Blade Size (mm)	Length (in.)
BT262R	SEMI-S	2PROGS	16 x 9	8 3/4
BT263R	SEMI-S	3PROGS	16 x 14	8 3/4
BT264R	SEMI-S	4PROGS	16 x 20	8 3/4
BT266R	SEMI-S	6PROGS	16 x 30	8 3/4
BT272R	BLUNT	2PROGS	15.5 x 9	8 3/4
BT273R	BLUNT	3PRONGS	15.5 x 14	8 3/4
BT274R	BLUNT	4PRONGS	15.5 x 20	8 3/4
BT276R	BLUNT	6PRONGS	15.5 x 30	8 3/4

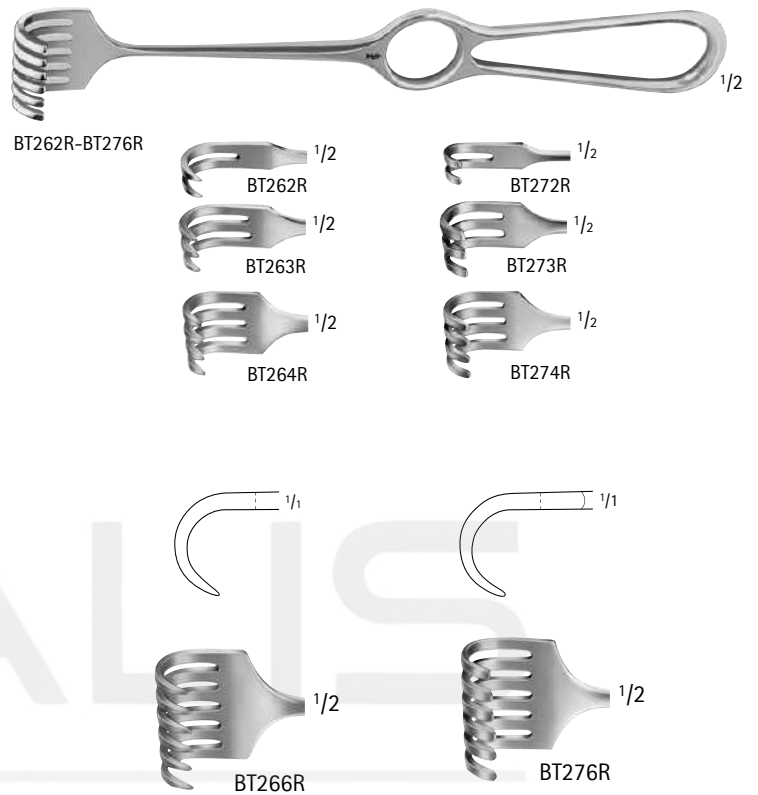

KOERTE RETRACTOR



BT278R-BT279R

Catalog Number	Tip	Blade End	Blade Size (mm)	Length (in.)
BT279R	SEMI-S	8PROGS	26 x 40	9 1/2
BT278R	BLUNT	8PRONGS	26 x 40	9 1/2

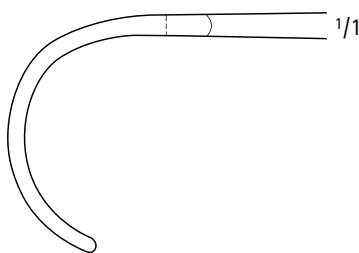

BT279R



BT278R

GENERAL SURGERY

Hand Held Retractors

ISRAEL RETRACTOR

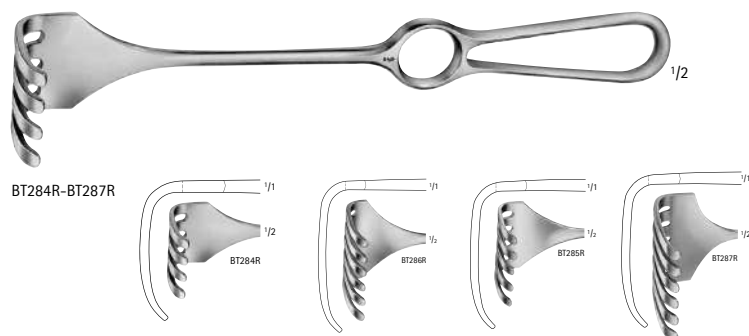

Catalog Number	Tip	Blade End	Blade Size (mm)	Length (in.)
BT284R	BLUNT	4PRONS	39 x 40	10
BT285R	BLUNT	5PRONS	47 x 51	10
BT286R	BLUNT	6PRONS	53 x 62	10
BT287R	BLUNT	6PRONS	70 x 70	10

ISRAEL RETRACTOR, T-HANDLE



Catalog Number	Tip	Blade End	Blade Size (mm)	Length (in.)
MG284R	BLUNT	4PRONS	46 x 40	7 1/2

MURPHY RETRACTOR

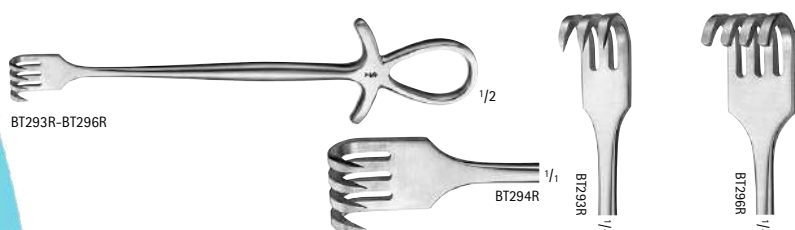

Catalog Number	Tip	Blade End	Length (in.)
BT293R	SHARP	3 PRONGS	7 3/4
BT294R	SHARP	4 PRONGS	7 3/4
BT296R	BLUNT	4 PRONGS	7 3/4

KOERTE-WAGNER RETRACTOR



Catalog Number	Tip	Blade End	Blade Size (mm)	Length (in.)
BT290R	SEMI-S	8PROGS	28 x 40	11

GENERAL SURGERY

Hand Held Retractors

LANGENBECK RETRACTOR

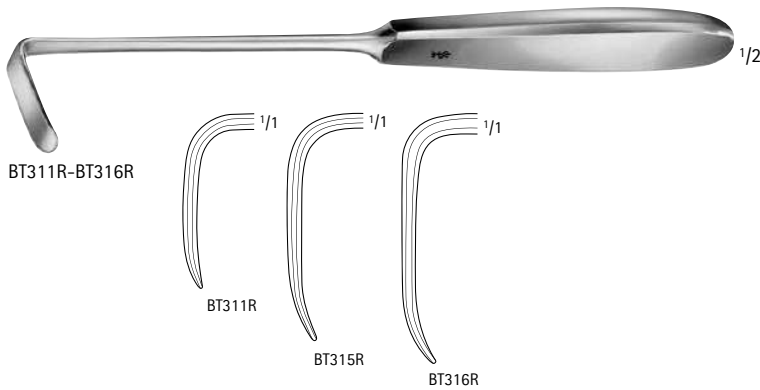

Catalog Number	Blade Size (mm)	Length (in.)
BT311R	30 x 10	9
BT315R	40 x 10	9
BT316R	43 x 13	9

SAUERBRUCH RETRACTOR

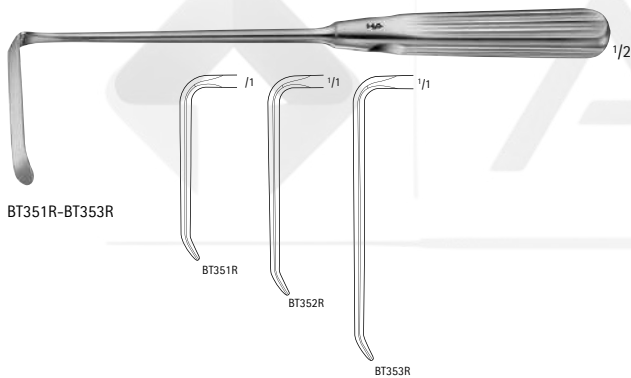

Catalog Number	Blade Size (mm)	Length (in.)
BT351R	46 x 16	8 7/8
BT352R	55 x 22	8 7/8
BT353R	72 x 19	8 7/8

KOCHER-LANGENBECK RETRACTOR

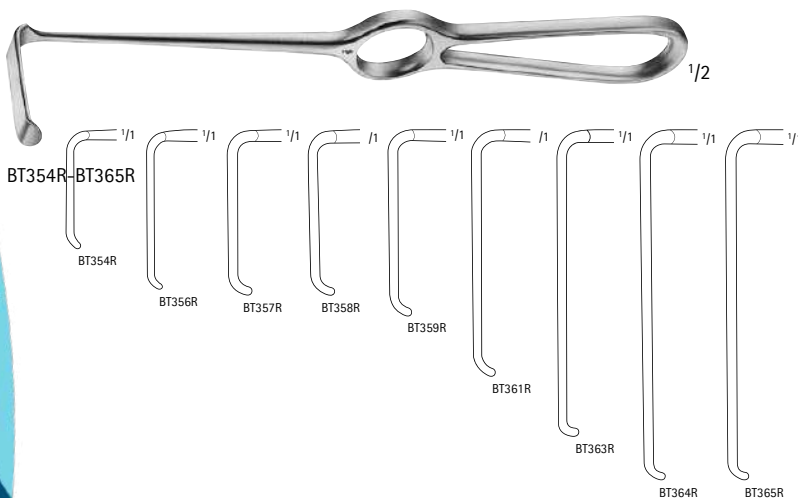

Catalog Number	Blade Size (mm)	Length (in.)
BT354R	25 x 6	8 1/2
BT356R	35 x 8	8 1/2
BT357R	35 x 11	8 1/2
BT358R	35 x 15	8 1/2
BT359R	41 x 11	8 1/2
BT361R	55 x 11	8 1/2
BT363R	70 x 14	8 1/2
BT364R	80 x 12	8 1/2
BT365R	80 x 16	8 1/2

GENERAL SURGERY

Hand Held Retractors

LAHEY GOITER RETRACTOR



Catalog Number	Blade Size (mm)	Length (in.)
MB785R	24 x 8	7 7/8

MCBURNIEY THYROID RETRACTOR



Catalog Number	Blade Size (mm)	Length (in.)
MB748R	20 x 10	7 1/2

MIDDELDORPF RETRACTOR



Catalog Number	Blade Size (mm)	Length (in.)
BT404R	15 x 15	8 3/4
BT405R	20 x 22	8 1/2
BT406R	28 x 28	9 1/4

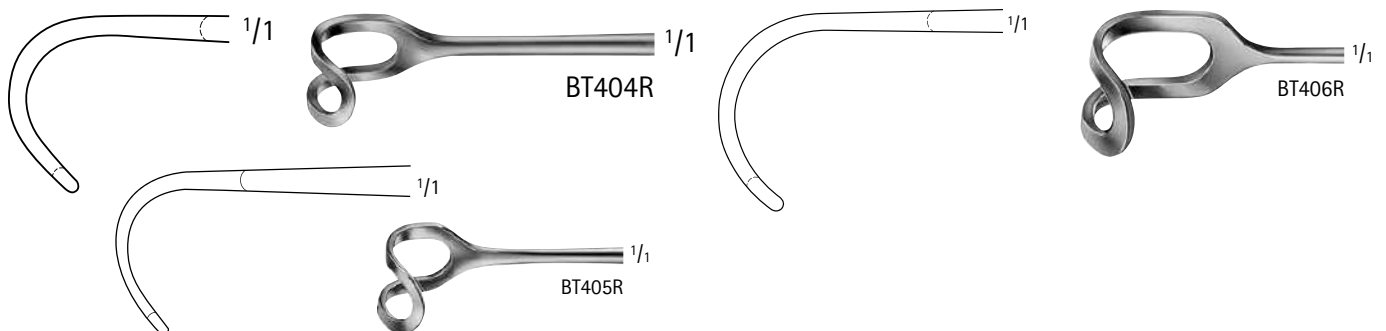

GENERAL SURGERY

Hand Held Retractors

DOCKHORN CHEEK RETRACTOR

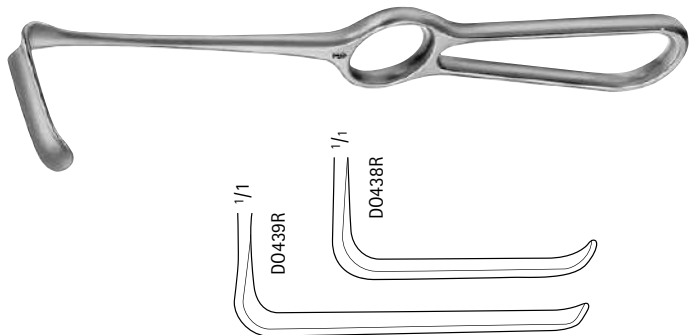

Catalog Number	Blade Size (mm)	Length (in.)
D0438R	40 x 12	8 1/4
D0439R	55 x 14	8 1/4

GENERAL SURGERY

Abdominal Retractors

HOESEL RETRACTOR

Catalog Number	Blade Size (mm)	Length (in.)
BT442R	100 x 30	9 3/4
BT446R	220 x 40	9 3/4



BT442R-BT446R

GENERAL SURGERY

Abdominal Retractors

KOCHER RETRACTOR

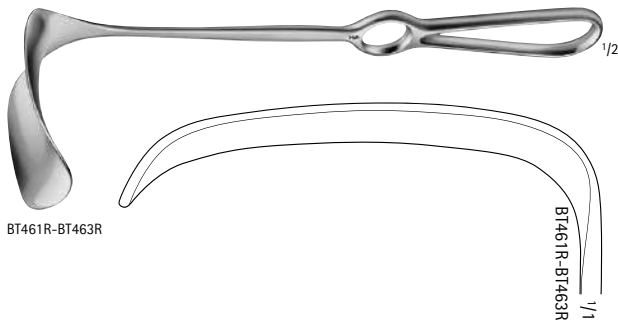

Catalog Number	Blade Size (mm)	Length (in.)
BT461R	80 x 42	9 3/4
BT462R	80 x 50	9 3/4
BT463R	80 x 60	9 3/4

KRAEMER RETRACTOR

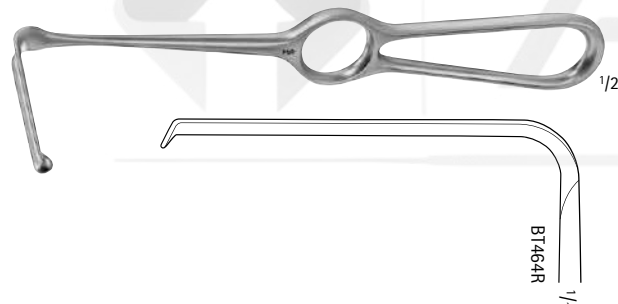

Catalog Number	Blade Size (mm)	Length (in.)
BT464R	66 x 10	8 1/4

CASPAR RETRACTOR

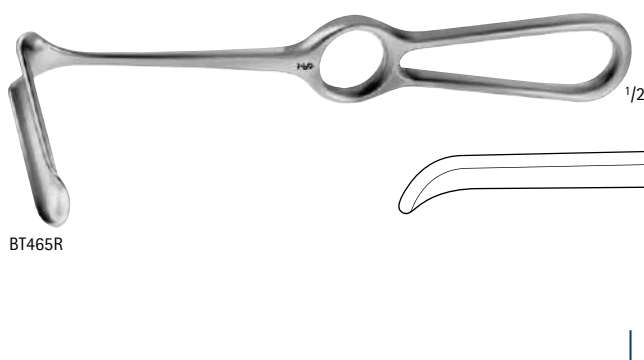

Catalog Number	Blade Size (mm)	Length (in.)
BT465R	67 x 17	8 1/4

GENERAL SURGERY

Abdominal Retractors

MIASPAS® MINI ALIF LANGENBECK RETRACTOR



BT450R-BT469R

Catalog Number	Blade Size (mm)	Length (in.)
BT450R	125 x 20	8 1/4
BT451R	125 x 35	8 1/4
BT466R	80 x 20	8 1/4
BT467R	110 x 20	8 1/4
BT468R	80 x 35	8 1/4
BT469R	110 x 35	8 1/4

RICHARDSON-EASTMAN RETRACTOR

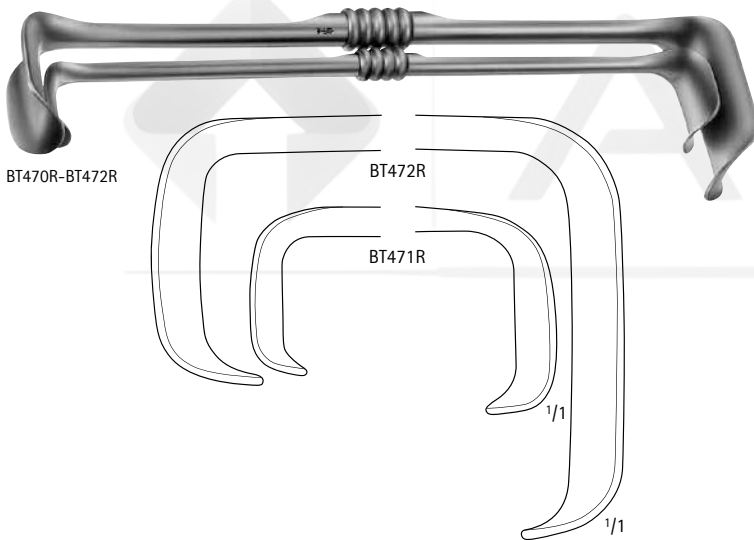

BT470R-BT472R

Catalog Number	Description	Tip	Length (in.)
BT470R	2/SET	S	9 3/4
BT471R	(BT471R, BT472R)	M	10 5/8
BT472R		LRG	

RICHARDSON RETRACTOR

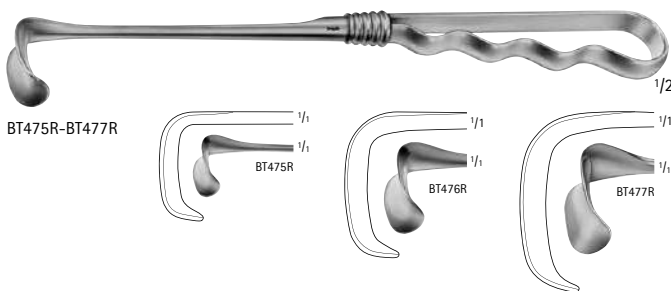

BT475R-BT477R

Catalog Number	Blade Size (mm)	Blade Size (in.)	Length (in.)
BT475R	23 x 20	1 x 3/4	9 1/2
BT476R	30 x 29	1 1/4 x 1 1/8	9 1/2
BT477R	37 x 37	1 1/2 x 1 1/2	9 1/2
BT478R	47 x 21	2 x 3/4	9 1/2

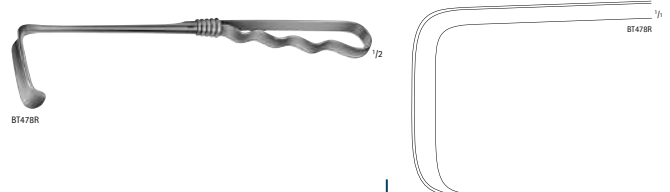

GENERAL SURGERY

Abdominal Retractors

RICHARDSON RETRACTOR

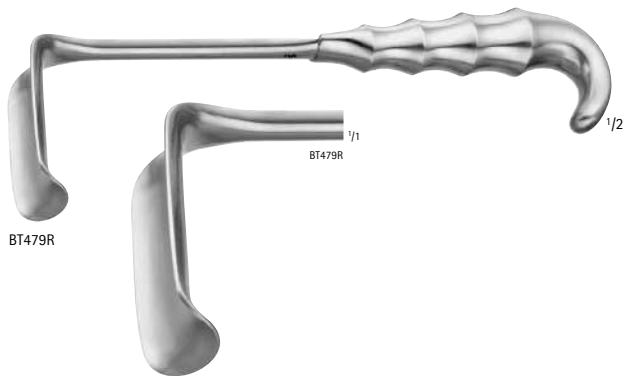

Catalog Number	Blade Size (mm)	Blade Size (in.)	Length (in.)
BT479R	65 x 41	2 1/2 x 1 5/8	9 3/4

KELLY RETRACTOR

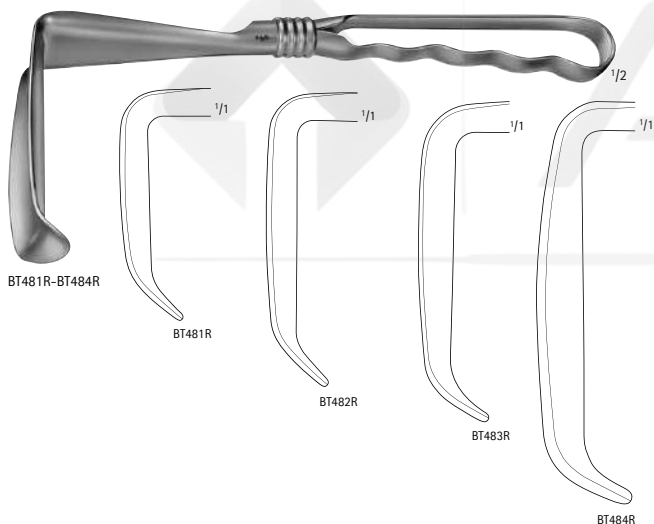

Catalog Number	Blade Size (mm)	Blade Size (in.)	Length (in.)
BT481R	50 x 40	2 x 1 1/2	10 1/4
BT482R	64 x 54	2 1/2 x 2	10 1/4
BT483R	70 x 65	2 3/4 x 2 1/2	10 1/4
BT484R	90 x 76	3 1/2 x 3	10 1/4

SAUERBRUCH RETRACTOR, OPEN

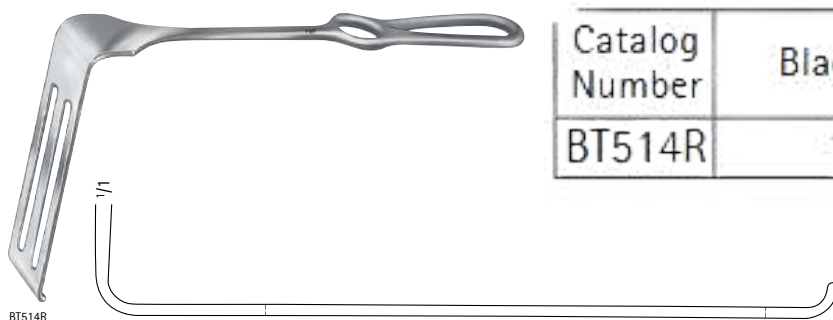

Catalog Number	Blade Size (mm)	Length (in.)
BT514R	130 x 38	10 1/4

GENERAL SURGERY

Abdominal Retractors

HARRINGTON LUNG SPATULA



BT551R, BT552R, MB930R

Catalog Number	Blade Size (mm)	Blade End	Length (in.)
BT551R	123 x 45	FLEX	11 5/8
BT552R	123 x 64	FLEX	11 5/8
MB930R	190 x 115	FLEX	12 1/2

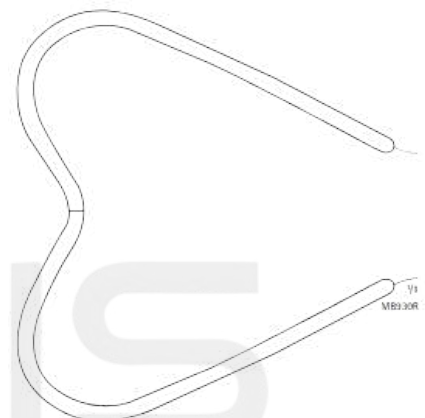
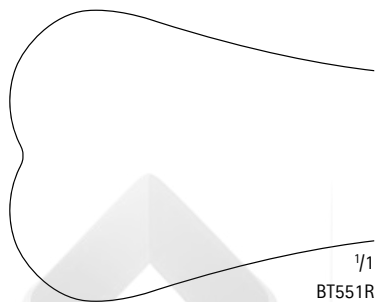

HARRINGTON RETRACTOR, LARGE BLADE

Catalog Number	Blade Size (mm)	Blade End	Length (in.)
MG472R	195 x 115	FLEX	14 3/8



MG472R

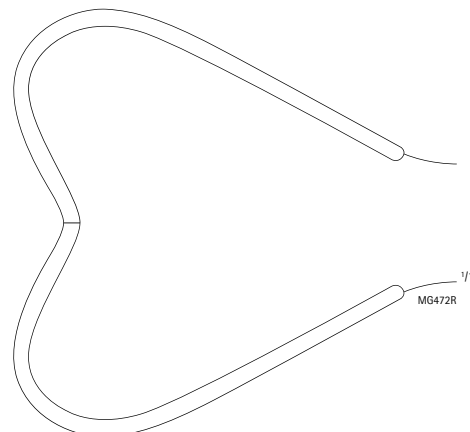

GENERAL SURGERY

Abdominal Retractors

HARRINGTON-PEMBERTON LUNG SPATULA

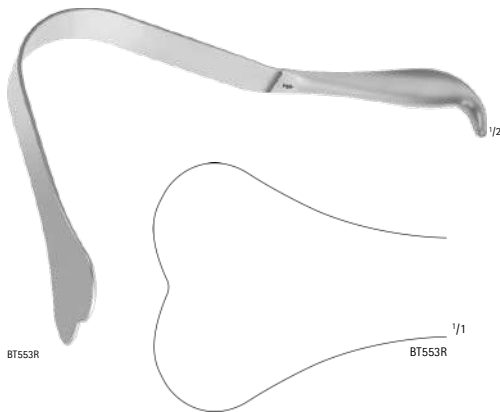

Catalog Number	Blade Size (mm)	Blade End	Length (in.)
BT553R	175 x 64	FLEX	11 5/8

ZENKER RETRACTOR

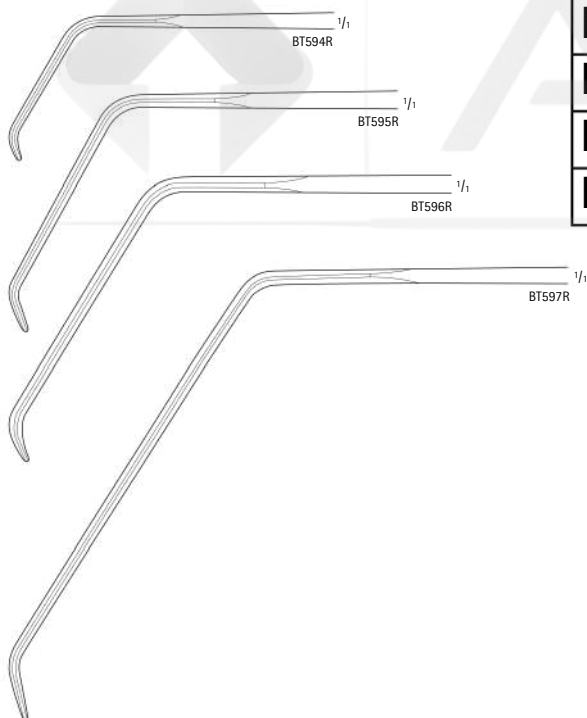

Catalog Number	Blade Size (mm)	Length (in.)
BT594R	36 x 8	9 1/2
BT595R	60 x 12	10
BT596R	75 x 12	10 5/8
BT597R	120 x 12	11 1/2

Catalog Number	Blade Size (mm)	Blade Size (in.)	Length (in.)
BT600R	19	3/4	7

DEAVER RETRACTOR

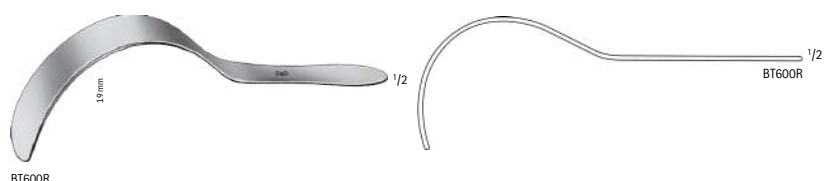

GENERAL SURGERY

Abdominal Retractors

DEAVER RETRACTOR, DOUBLE ENDED



Catalog Number	Blade Size (mm)	Blade Size (in.)	Length (in.)
BT606R	25	1	9 1/4

DEAVER RETRACTOR



Catalog Number	Blade Size (mm)	Blade Size (in.)	Length (in.)
BT601R	22	7/8	8 1/2
BT602R	25	1	11 3/4
BT603R	25	1	12 3/8

DEAVER RETRACTOR (CONTINUED)



Catalog Number	Blade Size (mm)	Blade Size (in.)	Length (in.)
BT604R	38	1 1/2	11 3/4

GENERAL SURGERY

Abdominal Retractors

DEAVER RETRACTOR (CONTINUED)



BT605R-BT607R

Catalog Number	Blade Size (mm)	Blade Size (in.)	Length (in.)
BT605R	50	2	12 1/4
BT607R	25	1	14 3/8

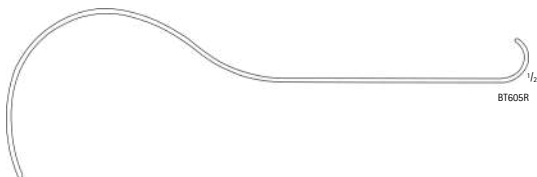

BT605R

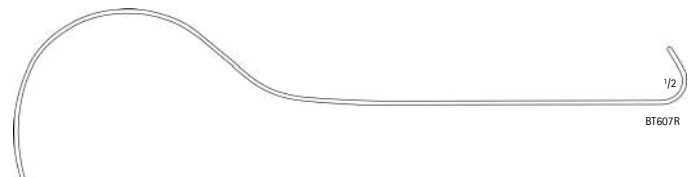

BT607R

DEAVER RETRACTOR (CONTINUED)



BT608R

Catalog Number	Blade Size (mm)	Blade Size (in.)	Length (in.)
BT608R	75	3	12 1/2



BT608R

DEAVER RETRACTOR, W/ GRIP



BT611R-BT615R

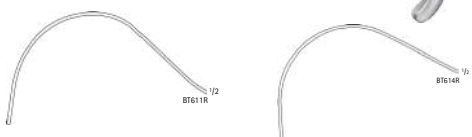

BT611R

BT614R



BT613R

BT615R

Catalog Number	Blade Size (mm)	Blade Size (in.)	Length (in.)
BT611R	25	1	12 1/4
BT613R	38	1 1/2	12 1/4
BT614R	50	2	12
BT615R	75	3	12 1/4

GENERAL SURGERY

Abdominal Retractors

HASSON "S" RETRACTOR, 2/SET

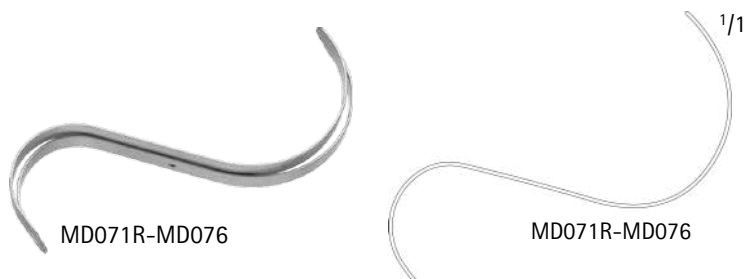

Catalog Number	Blade	Blade Size (mm)	Length (in.)
MD076	MALLEABLE	10	6 1/4
MD077	MALLEABLE	13	7
MD071R	RIGID	10	7 1/8
MD072R	RIGID	13	7 1/8

TUFFIER SPATULA, MALLEABLE



Catalog Number	Blade Size (mm)	Blade Size (in.)	Length (in.)
BT750R	17 / 25	3/4 / 1	7 7/8

RIBBON SPATULA, MALLEABLE



BT751R-BT763R, MD498, MG480R-MG484R

Catalog Number	Blade Size (mm)	Blade Size (in.)	Length (in.)
MG480R	5	1/8	8
BT751R	12	1/2	7 7/8
BT752R	17	3/4	7 7/8
MG481R	25	1	8
BT755R	25	1	9 3/4
MD498	75	3	13
MG482R	20	3/4	13
BT756R	25	1	13
BT761R	30	1 1/4	13
BT762R	40	1 1/2	13
BT763R	50	2	13
MG483R	65	2 1/2	13
MG484R	100	4	13

GENERAL SURGERY

Abdominal Retractors

HABERER SPATULA, MALLEABLE



BT758R

Catalog Number	Blade Size (mm)	Blade Size (in.)	Length (in.)
BT758R	40 / 50	1 1/2 / 2	12

SPATULA AND PACKER, DOUBLE ENDED

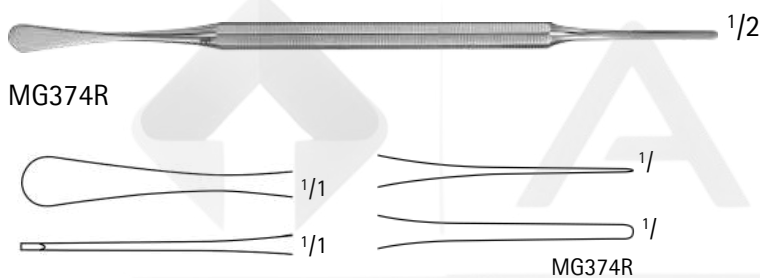

MG374R

Catalog Number	Length (in.)
MG374R	5 3/4

DOYEN ABDOMINAL RETRACTOR



BT667R



BT669R

Catalog Number	Blade Size (mm)	Length (in.)
BT667R	53 x 80	9 3/4
BT669R	72 x 82	10 1/4

Abdominal Retractors

1/1

BT667R

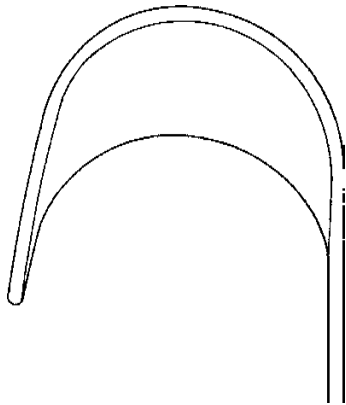

1/1

BT669R

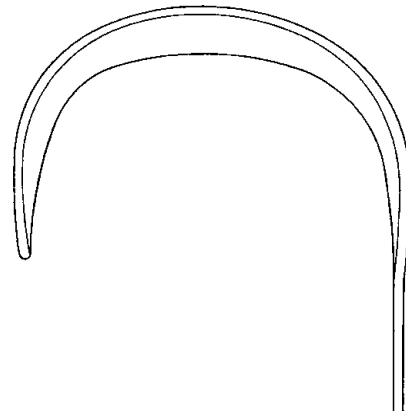

WEINBERG VAGOTOMY RETRACTOR, JOE'S HOE



MG491R

Catalog Number	Blade Size (mm)	Length (in.)
MG491R	47 x 57 / 93 x 157	9

ST. MARKS PELVIS RETRACTOR

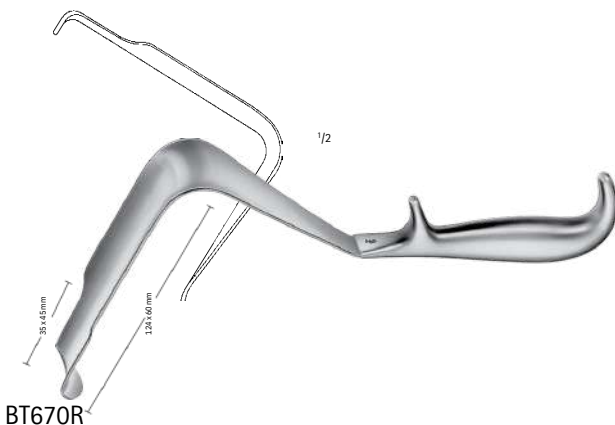

BT670R

Catalog Number	Blade Size (mm)	Length (in.)
BT670R	124 x 60	11 1/2
BT672R	174 x 60	13

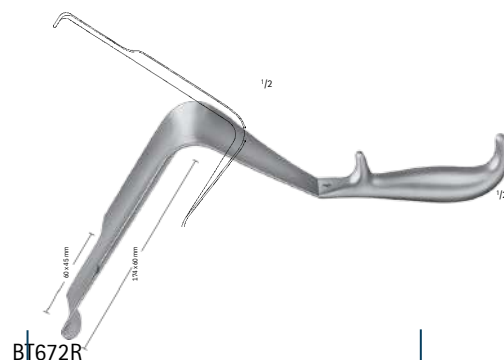

BT672R

GENERAL SURGERY

Abdominal Retractors

ST. MARKS PELVIS RETRACTOR (CONTINUED)

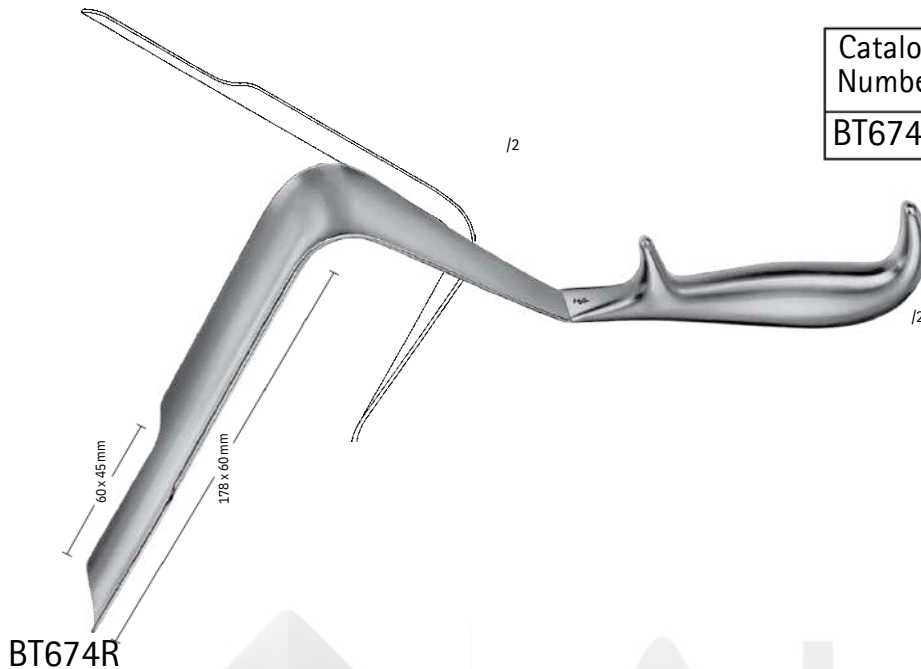

Catalog Number	Blade Size (mm)	Length (in.)
BT674R	178 x 60	13

MUELLER RETRACTOR

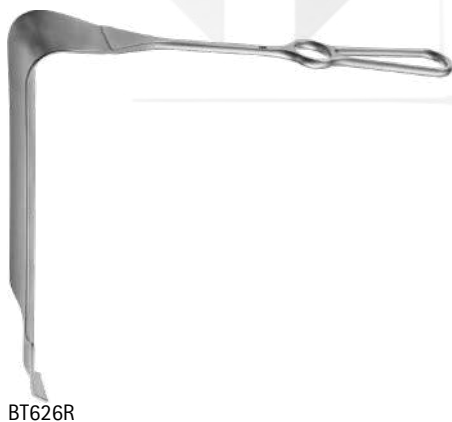

Catalog Number	Blade Size (mm)	Length (in.)
BT626R	250 x 30	10 5/8

MAYO-COLLINS APPENDECTOMY RETRACTOR

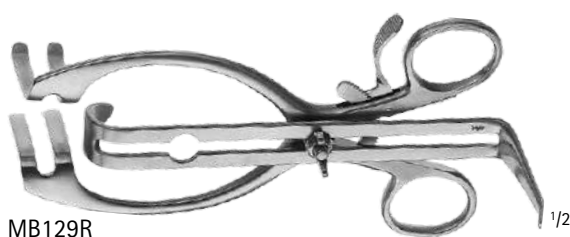

Catalog Number	Length (in.)
MB129R	6 3/4

GENERAL SURGERY

Abdominal Retractors

ROCHARD RETRACTOR MOUNTING FRAME, F/ BT711R-BT715R

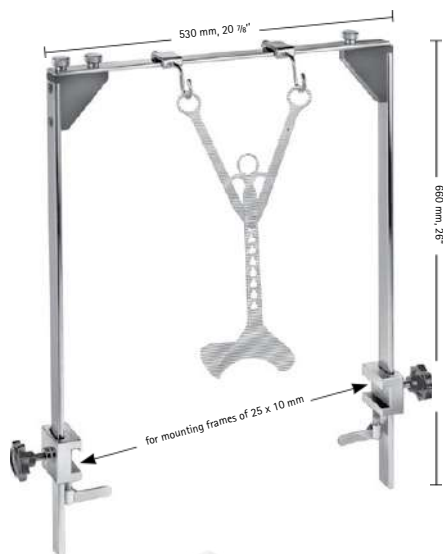

BT708R-BT709R

Catalog Number	Mounting Arms
BT708R	DOUBLE
BT709R	SINGLE

Mounting frame for fastening to the lateral bars of the operating tables, can be dismantled for decontamination and sterilization.

ROCHARD FIXATION DEVICE, F/ BT711R-BT715R

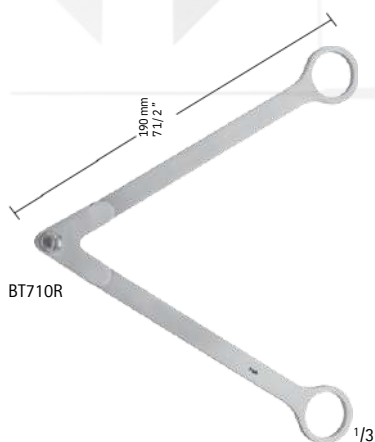

BT710R

Catalog Number	Length (mm)	Length (in.)
BT710R	190	7 1/2

ROCHARD BLADES



BT711R-BT715R

Catalog Number	Blade Size (mm)	Length (in.)
BT711R	48 x 90	12 1/4
BT712R	48 x 105	12 1/4
BT713R	48 x 120	12 1/4
BT714R	48 x 135	12 1/4
BT715R	48 x 155	12 1/4

GENERAL SURGERY

Abdominal Retractors

ABDOMINAL RETRACTOR, MALLEABLE, W/ HANDLE

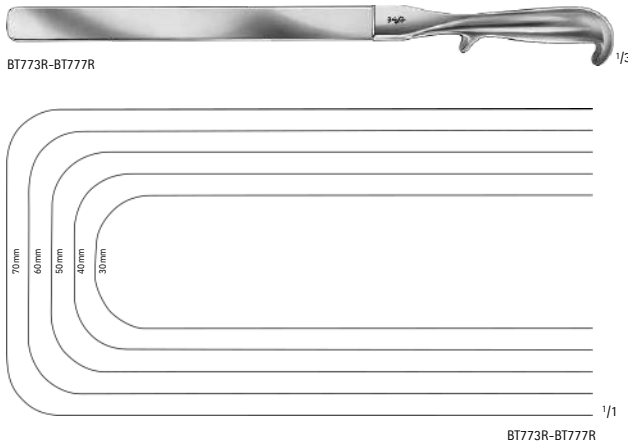

Catalog Number	Blade Size (mm)	Blade Size (in.)	Length (in.)
BT773R	30	1 1/4	16 1/8
BT774R	40	1 1/2	16 1/8
BT775R	50	2	16 1/8
BT776R	60	2 1/2	16 1/8
BT777R	70	2 3/4	16 1/8

LAPAROTOMY RING



MB226, MG582R-MG586R

Catalog Number	Diameter (in.)
MG582R	1 1/2
MG585R	1 3/4
MB226	2
MG586R	3

HERTZLER ABDOMINAL RETRACTOR

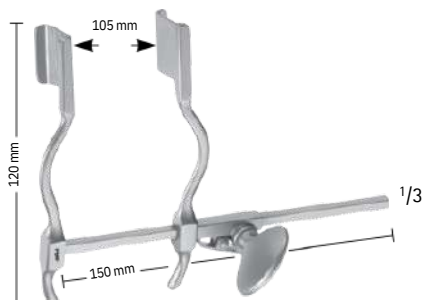

BV512R

Catalog Number	Blade Size (mm)
BV512R	20 x 25

COLLIN ABDOMINAL RETRACTOR W/ BALL SNAP CLOSURE

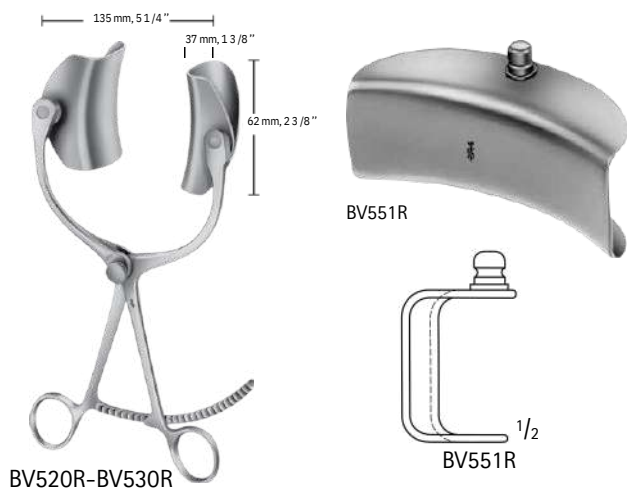

Catalog Number	Description
BV530R	SET COMPLETE BV520RSPREADER ONLY
BV551R	LATERAL BLADES, Pair, 37 x 62 MM

BLADE EJECTOR



Catalog Number	Description	Length (in.)
BV399R	FOR CHANGING BLADES WITH BALL SNAP CLOSURE	4 1/2

GOSSET ABDOMINAL RETRACTOR, SMALL



Catalog Number	Blade Depth (mm)
BV500R	38

GOSSET ABDOMINAL RETRACTOR, MEDIUM

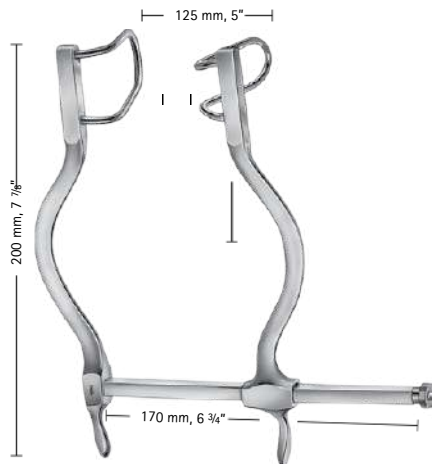

BV502R

Catalog Number	Blade Depth (mm)
BV502R	55

GOSSET ABDOMINAL RETRACTOR, LARGE

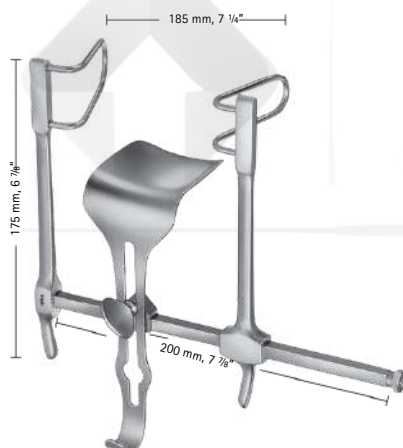

BV505R-BV506R

Catalog Number	Description
BV505R	SET COMPLETE
BV506R	CENTER BLADE ONLY 59 x 57 MM

BV505R Includes:
1 Center Blade BV506R

BALFOUR BABY ABDOMINAL RETRACTOR

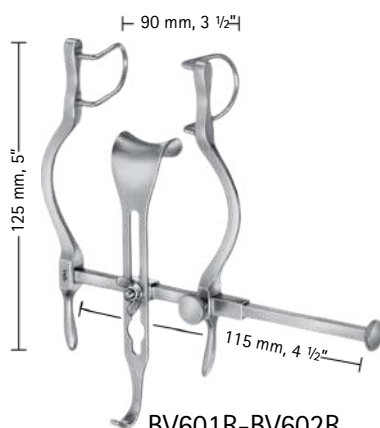

BV601R-BV602R

Catalog Number	Description
BV601R	SET COMPLETE
BV602R	CENTER BLADE ONLY, 21 x 24 MM

BV601R Includes:
1 Center Blade BV602R

GENERAL SURGERY

Abdominal Retractors

BALFOUR ABDOMINAL RETRACTOR

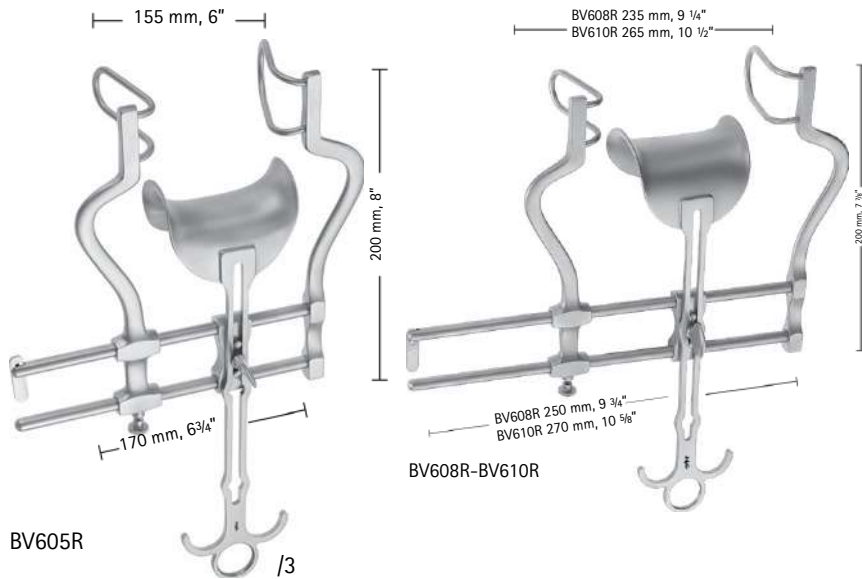

Catalog Number	Description	Lateral Blades Depth (mm)
BV605R	BALFOUR RETRACTOR, 200 x 155 MM	60
BV608R	BALFOUR RETRACTOR, 200 x 235 MM	60
BV610R	BALFOUR RETRACTOR, 200 x 265 MM	90
BV606R	CENTER BLADE, 47 x 80 MM	-
BV609R	CENTER BLADE, 62 x 76 MM	-
BV611R	CENTER BLADE, 80 x 80 MM	-

BV605R includes BV606R
 BV608R includes BV609R
 BV610R includes BV611R

BALFOUR ABDOMINAL RETRACTOR (CONTINUED)

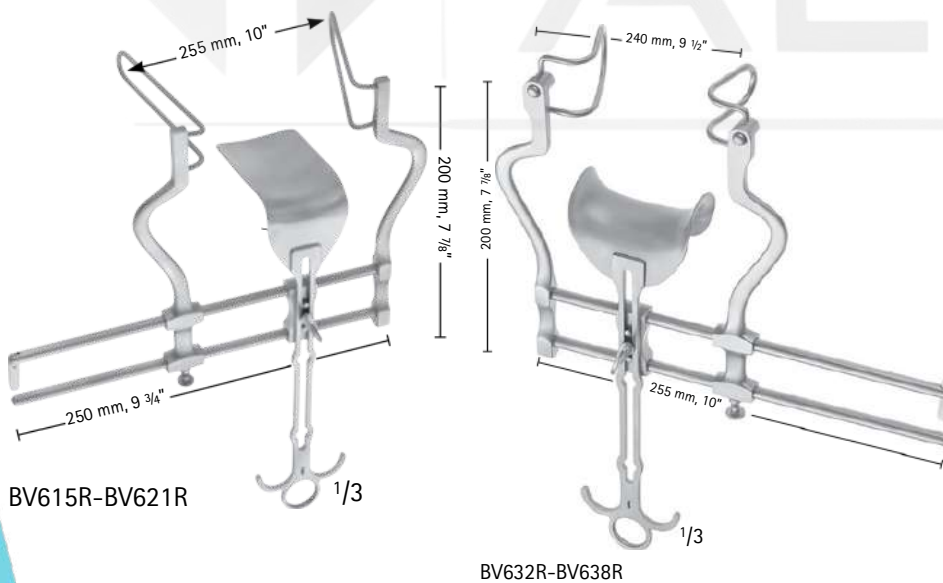

Catalog Number	Description
BV615R	BALFOUR RETRACTOR, 200 x 255 MM COMPLETE W/ BV616R
BV632R	BALFOUR RETRACTOR, COMPLETE W/ BV606R, BV621R, BV622R
BV634R	BALFOUR RETRACTOR, COMPLETE W / BV609R, BV621R, BV624R
BV636R	BALFOUR RETRACTOR, COMPLETE W/ BV611R, BV621R, BV626R
BV638R	BALFOUR RETRACTOR, COMPLETE W/
BV616R	BV611R, BV621R, BV628R CENTER BLADE,
BV621R	107 x 59 MMSREADER ONLY,
BV622R	200 x 250 MM LATERAL BLADE, PAIR 50 MM
BV624R	LATEAL BLADE, PAIR 60 MM
BV626R	LATERAL BLADE, PAIR 75 MM
BV628R	LATERAL BLADE, PAIR 90 MM

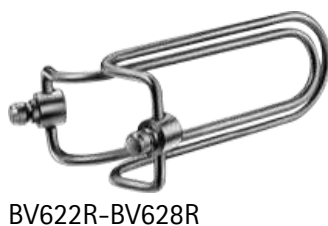

Abdominal Retractors

BALFOUR SIDE BLADE SOLID F/ RETRACTOR

MB221R, MB222R



Catalog Number	Description
MB637R	PAIR, 2 1/2" (64 MM) DEEP
MB638R	PAIR, 3 1/2" (89 MM) DEEP
MB639R	PAIR, 4" (102 MM) DEEP

BALFOUR SIDE BLADE WIRE F/ RETRACTOR MB221R,

MB222R



Catalog Number	Description
MB577R	PAIR, 2 1/2" (64 MM) DEEP
MB578R	PAIR, 3 1/2" (89 MM) DEEP
MB579R	PAIR, 4" (102 MM) DEEP

BALFOUR RETRACTOR W/ EXCHANGEABLE LATERAL

BLADES

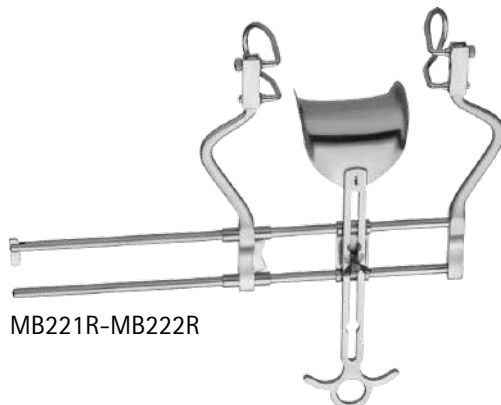

Catalog Number	Total Width (in.)	Opening Width (in.)	Description
MB221R	16	10 1/2	2 PAIRS OF DETACHABLE BLADES 2 1/2" AND 3 1/2", 1 CENTER BLADE 2 3/4" x 3 1/4"
MB222R	16	8 1/2	2 PAIRS OF DETACHABLE BLADES 2 1/2" AND 3 1/2", 1 CENTER BLADE 2 1/2" x 2 1/2"

GENERAL SURGERY

Abdominal Retractors

BALFOUR RETRACTOR

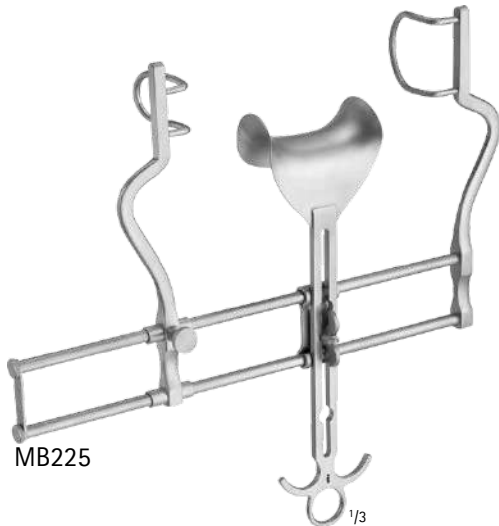

Catalog Number	Total Width (in.)	Opening Width (in.)	Description
MB225	13	11	2 LATERAL BLADES 2" x 2" AND 1 1/4" x 2", 1 CENTER BLADE 3" x 10 1/2"

DIXON CENTER BLADE



MB573R-MB574R

Catalog Number	Blade	Blade Size (mm)
MB573R	MALLEABLE	171 x 51
MB574R	MALLEABLE	267 x 57

BALFOUR CENTER BLADE FOR ALL BALFOUR RETRACTORS



BV617R

Catalog Number	Blade Size (mm)
BV617R	54 x 80

GENERAL SURGERY

Abdominal Retractors

CENTER BLADE F/ BV615R



BV618R

Catalog Number	Blade Size (mm)
BV618R	75 x 80

BALFOUR RETRACTOR EXTENSION ARM

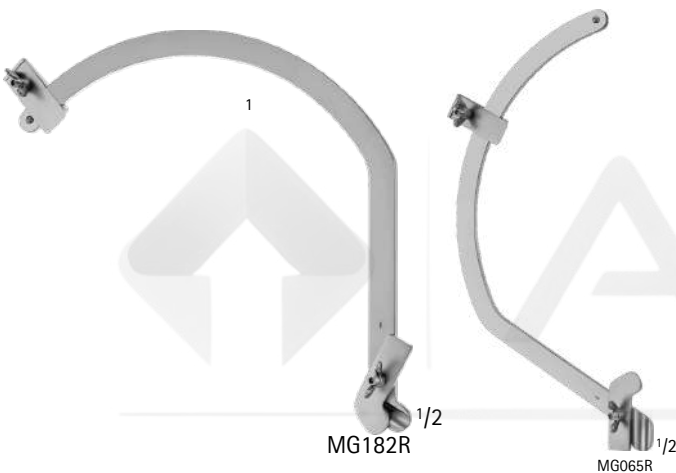

Catalog Number	Description	Length (in.)
MG065R	ADULT ABDOMINAL, 4" BLADE F/ RIGHT ARM	9 1/2
MG182R	ADULT ABDOMINAL, 4" BLADE F/ LEFT ARM	9 1/2

DENIS-BROWNE ABDOMINAL RETRACTOR

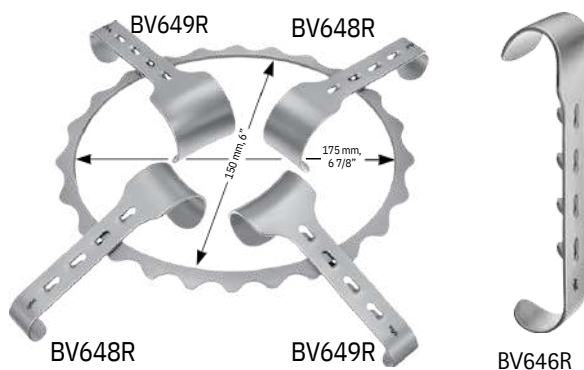

Catalog Number	Description
BV650R	COMPLETE SET 2 BLADES ONLY,
BV648R	40 x 30 MM 2 BLADES ONLY,
BV649R	40 x 40 MM BLADE ONLY,
BV646R	20 x 30 MM

BV650R Includes:

1 Frame

2 Blades of each BV648R and BV649R

GENERAL SURGERY

Abdominal Retractors

SEMM ABDOMINAL RETRACTOR

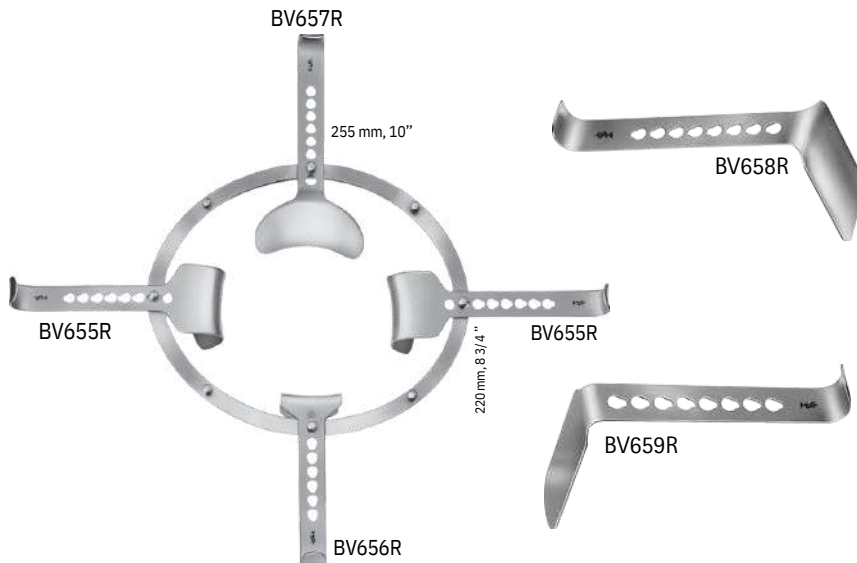

Catalog Number	Description	Blade Size (mm)
BV654R	COMPLETE	-
BV653R	SET FRAME	-
BV655R	2 BLADES	46 x 64
BV656R	BLADE	53 x 54
BV657R	BLADE	82 x 97
BV658R	BLADE	98 x 51
BV659R	BLADE	107 x 36

BV654R Includes:
 1 Frame BV653R
 1 Blade of each BV656R, BV657R, BV658R and BV659R
 2 Blades BV655R

GENERAL SURGERY

Universal Ring Retractor System

UNIVERSAL RING RETRACTOR SYSTEM



Catalog Number	Description
MB499R	COMPLETE SET
Complete System Includes:	
MB497	Segmented Medium Oval Ring
MB516	Medium Oval Ring
MB506	Standard Table Clamp 18"
MB488R	Horizontal Flex Bar w/ 360° Rotation 19 1/4"
MB487R	Horizontal Fixed Bar 15 1/2"
MB504	Post Clamp for 1" Bar
MB503	Non-Tilting Blade Clamp (2 each)
MB510	Tilting Blade Clamp (6 each)
MB524	KELLY Retractor Blade 2" x 3" (2 each)
MB525	KELLY Retractor Blade 2" x 4"
MB526	KELLY Retractor Blade 2" x 5"
MB527	KELLY Retractor Blade 2" x 6"
MB529	Malleable Retractor Blade 1 1/2" x 6"
MB530	Malleable Retractor Blade 2" x 6"
MB532	Malleable Retractor Blade 3" x 6"
MB534	BALFOUR Bladder Blade 3" x 2 1/2"
MB544	HARRINGTON Sweetheart Blade 2 1/2" x 5"
MB546	GELPI Point Retractor Blade

GENERAL SURGERY

Universal Ring Retractor System

System

OVAL RING



MB515-MB517

Catalog Number	Size	Width x Length (in.)
MB515	SMALL	8 1/2 x 12
MB516	MEDIUM	10 1/2 x 15
MB517	LARGE	12 1/2 x 18 1/2

SEGMENTED OVAL RING

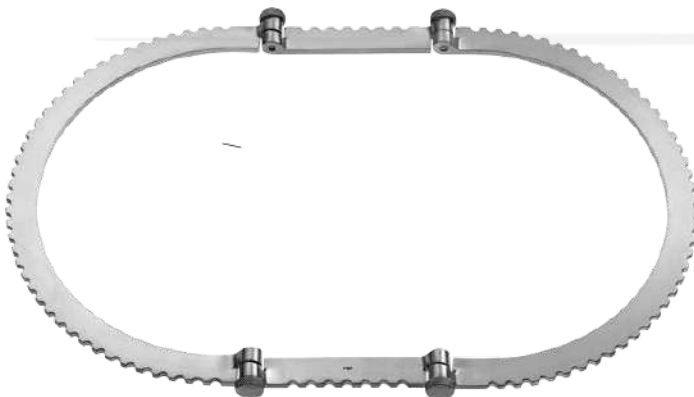

MB496-MB462R

Catalog Number	Size	Description	Width x Length (in.)
MB496	SMALL	INCLUDES REMOVABLE 4" SEGMENTS	8 1/2 x 14
MB497	MEDIUM	INCLUDES REMOVABLE 8" SEGMENTS	10 1/2 x 19 1/2
MB498	LARGE	INCLUDES REMOVABLE 6" SEGMENTS	12 1/2 x 19 1/2
MB462RX-LARGE		INCLUDES REMOVABLE 6" SEGMENTS	16 x 22

GENERAL SURGERY

Universal Ring Retractor System



SEGMENTS FOR SEGMENTED OVAL RING, PAIR



MB471R-MB473R

Catalog Number	Length (in.)
MB471R	4
MB472R	6
MB473R	8

URRS SEGMENTED RING SCREW



MB564

Catalog Number
MB564

ROUND RING

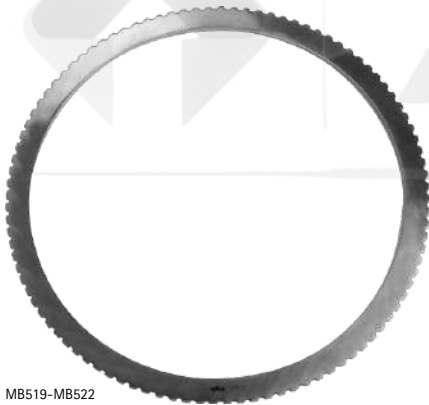

MB519-MB522

Catalog Number	Size	Diameter (in.)
MB519	SET	-
MB520	SMALL	8 1/2
MB521	MEDIUM	10 1/2
MB522	LARGE	12 1/2

MB519 Includes:
1 Ring of each MB520-MB522

SEGMENTED ROUND RING

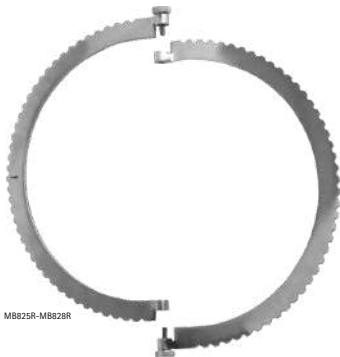

MB825R-MB828R

Catalog Number	Size	Diameter (in.)
MB825R	SMALL	8 1/2
MB826R	MEDIUM	10 1/2
MB827R	LARGE	12 1/2
MB828R	X-LARGE	16

GENERAL SURGERY

Universal Ring Retractor System



VAGINAL RING

Catalog Number	Description	Width x Length (in.)
MB489	20° ANGLE	8 x 10 1/2



MB489

TILT AND SWIVEL CLAMP

Catalog Number
MG511R



MG511R

MULTI DIRECTIONAL BLADE CLAMP

Catalog Number
MB973R

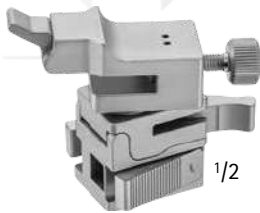

MB973R

NON-TILTING BLADE CLAMP

Catalog Number
MB503



MB503

TILTING BLADE CLAMP

Catalog Number
MB510



MB510

POST CLAMP

Catalog Number
MB504

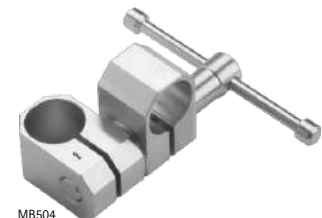

MB504

GENERAL SURGERY Universal Ring Retractor System

TABLE CLAMP

Catalog Number	Working Length (in.)	Length (in.)
MB506	15	18
MB460R	21	24



MB460R-MB506

FLAT TABLE CLAMP

Catalog Number	Working Length (in.)	Total Length (in.)
MB670R	11	18
MB821R	1/2 17	24



MB670R-MB821R

HORIZONTAL FIXED BAR

Catalog Number	Length (in.)
MB487R	15 1/2
MB823R	22



MB487R-MB823R

HORIZONTAL FLEX BAR W/ 360° ROTATION

Catalog Number	Length (in.)
MB488R	19
MB824R	22 1/2



MB488R-MB824R

VERTICAL EXTENSION BAR

Catalog Number	Length (in.)
MB508	12
MB822R	14



MB508-MB822R

ADAPTER FOR ATTACHING HANDHELD RETRACTORS

Catalog Number
MB509



MB509

KELLY RETRACTOR BLADE

Catalog Number	Description	Width x Depth (in.)
MB555	-	1 x 1 1/2
MB556	-	1 x 2 1/2
MB936R	-	2 x 1 1/2
MB937R	-	2 x 2 1/2
MB524	-	2 x 3
MB525	-	2 x 4
MB526	-	2 x 5
MB527	-	2 x 6
MB469R	BARIATRIC	2 x 8

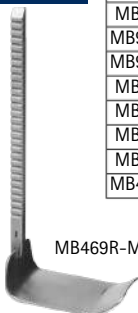

MB469R-MB555

GENERAL SURGERY

Universal Ring Retractor System



ALUMINUM KELLY RETRACTOR BLADE

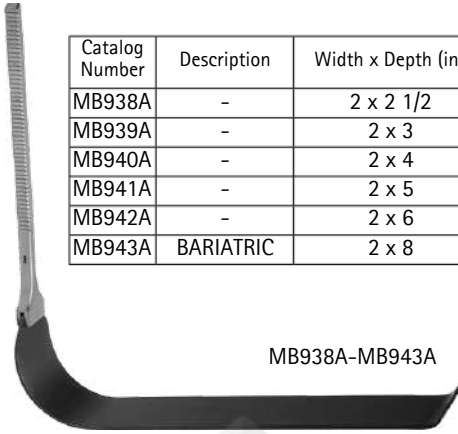

MB938A-MB943A

Catalog Number	Description	Width x Depth (in.)
MB938A	-	2 x 2 1/2
MB939A	-	2 x 3
MB940A	-	2 x 4
MB941A	-	2 x 5
MB942A	-	2 x 6
MB943A	BARIATRIC	2 x 8

MALLEABLE RETRACTOR BLADE

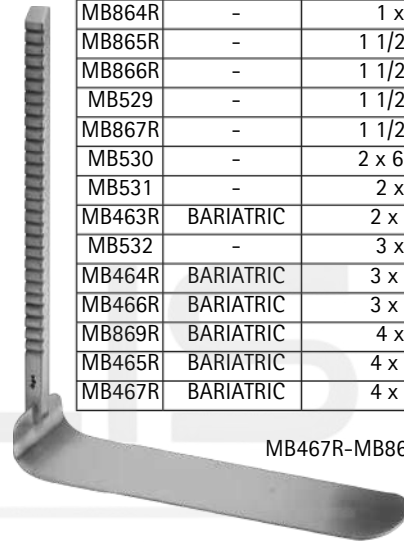

MB467R-MB860R

Catalog Number	Description	Width x Depth (in.)
MB860R	-	3/4 x 2
MB861R	-	3/4 x 3
MB862R	-	1 x 1
MB863R	-	1 x 4
MB864R	-	1 x 5
MB865R	-	1 1/2 x 3
MB866R	-	1 1/2 x 4
MB529	-	1 1/2 x 6
MB867R	-	1 1/2 x 8
MB530	-	2 x 6 1/2
MB531	-	2 x 8
MB463R	BARIATRIC	2 x 10
MB532	-	3 x 6
MB464R	BARIATRIC	3 x 10
MB466R	BARIATRIC	3 x 12
MB869R	BARIATRIC	4 x 8
MB465R	BARIATRIC	4 x 10
MB467R	BARIATRIC	4 x 12

ALUMINUM MALLEABLE RETRACTOR BLADE, FLAT



MB954A-MB959A

Catalog Number	Description	Width x Depth (in.)
MB954A	-	1 1/2 x 6
MB955A	-	2 x 6
MB956A	-	2 x 8
MB957A	-	3 x 6
MB958A	BARIATRIC	2 x 10
MB959A	BARIATRIC	3 x 10

RICHARDSON RETRACTOR



MB557-MB559

Catalog Number	Width x Depth (in.)
MB557	3/4 x 1
MB558	3/4 x 2
MB559	1 x 1 1/4

GENERAL SURGERY

Universal Ring Retractor System

BALFOUR BLADDER BLADE

Catalog Number	Description	Width x Depth (in.)
MB534	-	3 x 2 1/2
MB535	-	3 x 3 1/4
MB470R	BARIATRIC	3 x 3 1/2



MB470R-MB534

MAYO RETRACTOR BLADE

Catalog Number	Width x Depth (in.)
MB968R	1 1/4 x 1 1/4
MB969R	2 x 2



MB968R-MB969R

DEAVER RETRACTOR BLADE

Catalog Number	Width x Depth (in.)
MB537	1 x 4 1/2
MB538	1 1/2 x 4 1/2
MB539	2 x 4 1/2

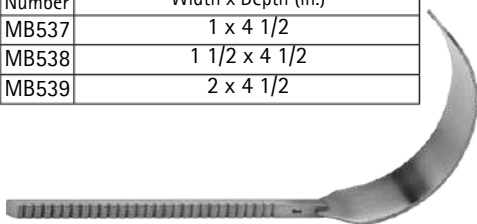

MB537-MB539

ALUMINUM BALFOUR BLADDER BLADE

Catalog Number	Width x Depth (in.)
MB829A	2 x 2 3/8
MB830A	3 x 2 1/2



MB829A-MB830A

ALUMINUM MAYO RETRACTOR BLADE

Catalog Number	Width x Depth (in.)
MB970A	2 3/4 x 2



MB970A

DEAVER VAGINAL RETRACTOR BLADE

Catalog Number	Description	Width x Depth (in.)
MB492	SMALL	1 x 3 1/2
MB493	LARGE	1 x 5

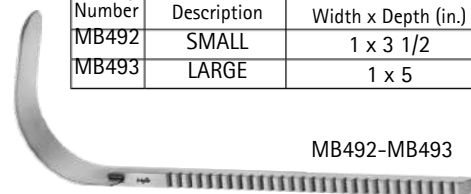

MB492-MB493

GENERAL SURGERY

Universal Ring Retractor System



VAGINAL RETRACTOR POSTERIOR BLADE

Catalog Number	Width x Depth (in.)
MB490	1 x 4 1/2

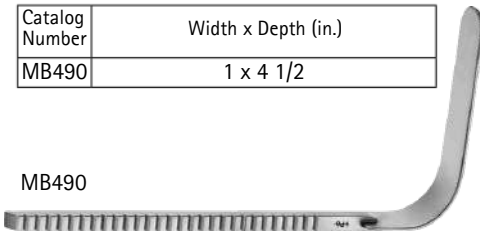

MB490

VAGINAL RETRACTOR LATERAL BLADE

Catalog Number	Width x Depth (in.)
MB491	1 x 3

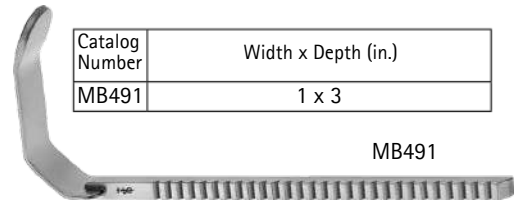

MB491

ST. MARK'S DEEP PELVIC RETRACTOR BLADE

Catalog Number	Width x Depth (in.)
MB871R	2 3/8 x 7 1/2

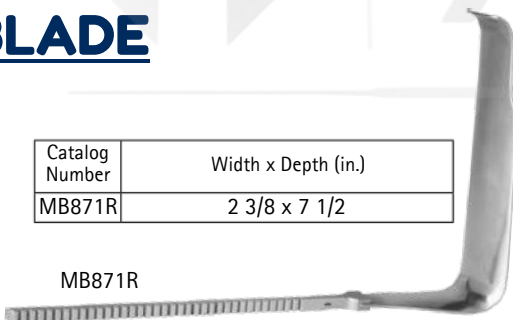

MB871R

RECTAL BLADE

Catalog Number	Description	Width x Depth (in.)
MB494	SMALL	7/8 x 2 7/8
MB495	LARGE	7/8 x 3 7/8



MB494-MB495

SKIN INCISION BLADE

Catalog Number	Width x Depth (in.)
MB541	1 1/8 x 3 1/4

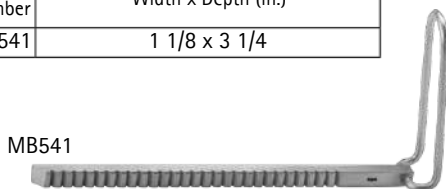

MB541

GELPI POINT RETRACTOR BLADE

Catalog Number
MB546



MB546

GENERAL SURGERY

Universal Ring Retractor System

HARRINGTON SWEETHEART BLADE

Catalog Number	Description	Width x Depth (in.)
MB543	-	1 1/2 x 5
MB544	-	2 1/2 x 5 5/8
MB468R	BARIATRIC	3 1/2 x 10
MB832R	BARIATRIC	4 1/2 x 10

MB543-MB832R

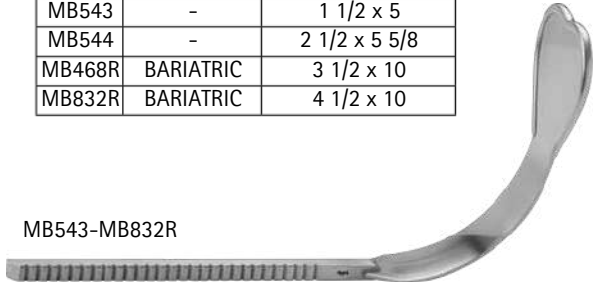

ALUMINUM HARRINGTON SWEETHEART BLADE

Catalog Number	Description	Width x Depth (in.)
MB833A	-	2 1/2 x 4
MB834A	-	3 1/2 x 8
MB835A	BARIATRIC	3 1/2 x 10

MB833A-MB835A

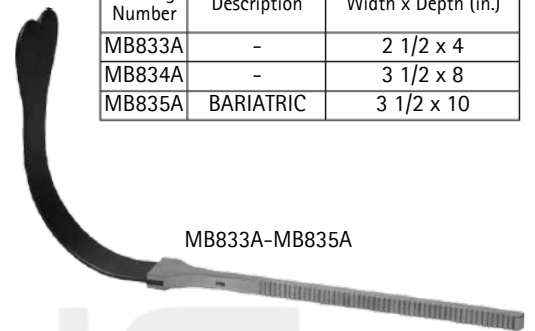

SCOVILLE HOOK RETRACTOR BLADE

Catalog Number	Description	Depth (in.)
MB549	SMALL	2
MB548	LARGE	3 1/4

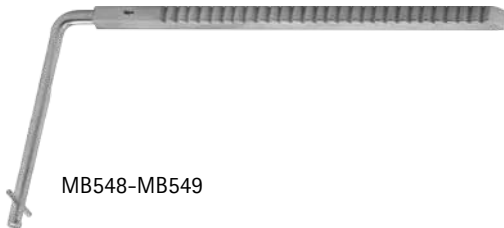

MB548-MB549

RAKE RETRACTOR

Catalog Number	Description	Width x Depth (in.)
MB566	3 PRONGS	2/3 x 3/4
MB567	4 PRONGS	3/4 x 1/3
MB568	6 PRONGS	1 x 1/3



MB566-MB568

MEYERDING RETRACTOR BLADE

Catalog Number	Width x Depth (in.)
MB551	1 x 3 1/3
MB552	2 x 3 3/4
MB553	2/3 x 2 1/3



MB551-MB553

GENERAL SURGERY

Universal Ring Retractor System

ALUMINUM RENAL RETRACTOR BLADE

Catalog Number	Width x Depth (in.)
MB962A	1 x 4
MB963A	1 x 6
MB964A	1 x 8
MB965A	1 x 10



MB962A-MB965A

ALUMINUM SPLANCHNIC RETRACTOR BLADE

Catalog Number	Width x Depth (in.)
MB966A	2 x 10
MB967A	3 x 8

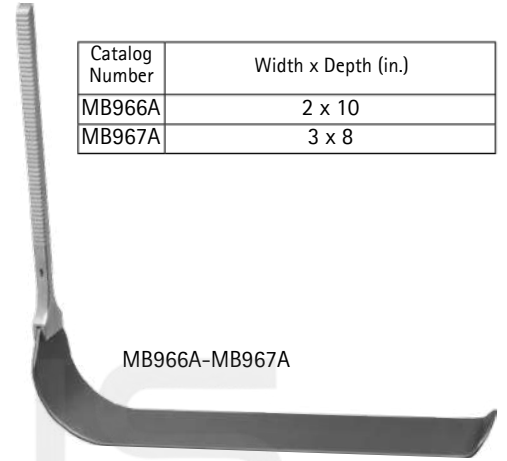

MB966A-MB967A

PERFORATED SUPER MALLEABLE RETRACTOR BLADE

Catalog Number	Width x Depth (in.)
MB960R	2 x 9
MB961R	3 x 9



MB960R-MB961R

YU-HOLTGREWE MALLEABLE RETRACTOR BLADE

Catalog Number	Width x Depth (in.)
MB870R	2 1/2 x 6



MB870R

GENERAL SURGERY

Self Retaining Retractors

FINSEN RETRACTOR

Catalog Number	Tip	Blade End	Length (in.)
BV001R	SHARP	2 x 3 PRONGS	2



FINSEN RETRACTOR

Catalog Number	Tip	Blade End	Length (in.)
BV002R	SHARP	3 x 4 PRONGS	2 3/4



FINSEN MODIFIED RETRACTOR

Catalog Number	Tip	Blade End	Length (in.)
BV003R	BLUNT	2 x 3 PRONGS	3



FINSEN RETRACTOR

Catalog Number	Tip	Blade End	Length (in.)
BV005R	SHARP	3 x 4 PRONGS	2 3/4



PARSONNET EPICARDIAL RETRACTOR

Catalog Number	Tip	Blade End	Length (in.)
BV014R	SHARP	3 x 3 PRONGS	2

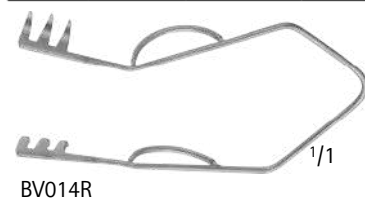

SPRING WIRE RETRACTOR

Catalog Number	Tip	Prongs	Length (in.)
BV006R	BLUNT	3 x 3	1 3/4
BV007R	BLUNT	3 x 3	2 1/4
MD471	SHARP	1 x 1	3

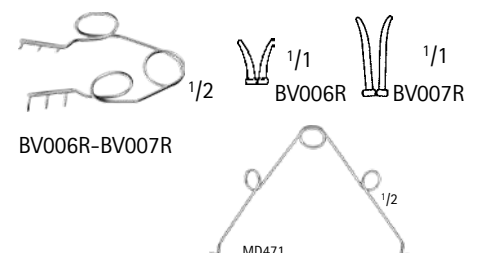

GENERAL SURGERY

Self Retaining Retractors

SPRING WIRE RETRACTOR

Catalog Number	Size	Length (in.)
MB777R	SMALL	5
MB778R	MEDIUM	5 1/8
MB196R	LARGE	9

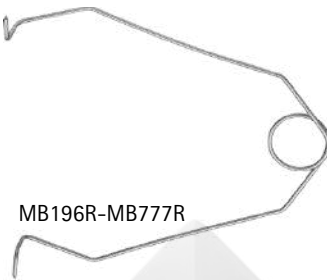

WEITLANER RETRACTOR

Catalog Number	Tip	Blade End	Length (in.)
BV073R	BLUNT	2 x 3 PRONGS	4 1/4
MA438R	BLUNT	3 x 3 PRONGS	4 1/4
BV074R	BLUNT	3 x 4 PRONGS	5 1/8
BV075R	BLUNT	3 x 4 PRONGS	6 1/2
BV104R	BLUNT/ DEEP	3 x 4 PRONGS	5 1/8

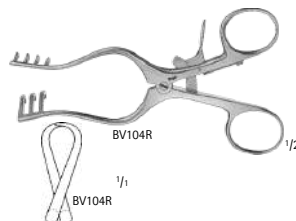
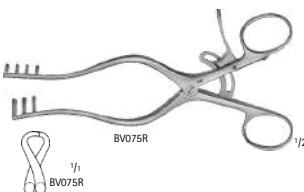
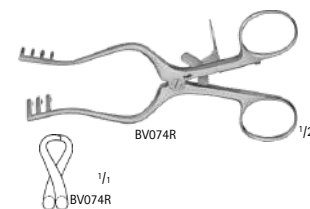
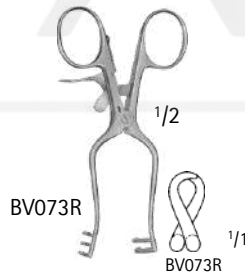
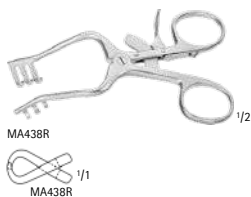

ALM RETRACTOR

Catalog Number	Tip	Blade End	Length (in.)
BV010R	SHARP	4 x 4 PRONGS	2 3/4
BV011R	SHARP	4 x 4 PRONGS	4

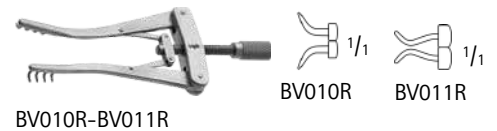

HEISS SELF-RETAINING RETRACTOR

Catalog Number	Tip	Blade End	Length (in.)
BV015R	SHARP	4 x 4 PRONGS	4
BV008R	BLUNT	4 x 4 PRONGS	4

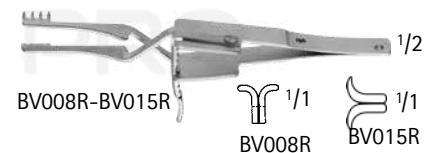

GENERAL SURGERY

Self Retaining Retractors

WEITLANER RETRACTOR

Catalog Number	Tip	Blade End	Length (in.)
BV070R	SHARP	2 x 3 PRONGS	4 1/4
BV071R	SHARP	3 x 4 PRONGS	5 1/8
BV072R	SHARP	3 x 4 PRONGS	6 1/2
BV101R	SHARP/DEEP	3 x 4 PRONGS	5 1/8
BV066R	SEMI-S	2 x 3 PRONGS	4 1/4
BV067R	SEMI-S	3 x 4 PRONGS	5 1/8
BV068R	SEMI-S	3 x 4 PRONGS	6 1/2

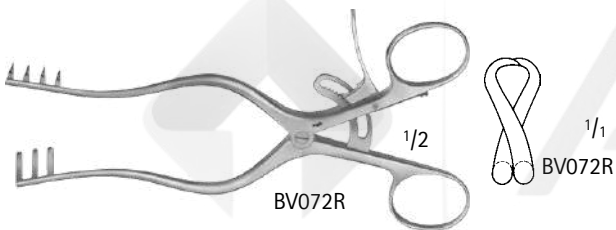
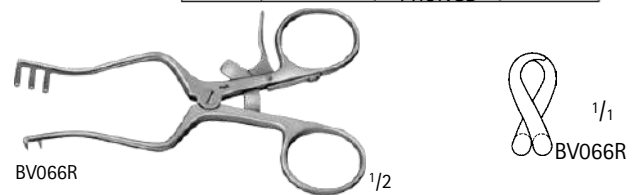

WULLSTEIN RETRACTOR

Catalog Number	Tip	Blade End	Length (in.)
BV076R	SHARP	3 x 3 PRONGS	5
BV077R	BLUNT	3 x 3 PRONGS	5

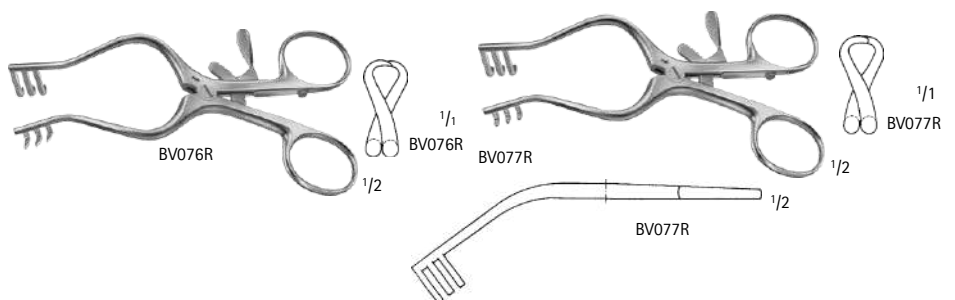

GENERAL SURGERY

Self Retaining Retractors

BABY ADSON RETRACTOR, HINGED

Catalog Number	Tip	Blade End	Length (in.)
BV085R	SEMI-S	3 x 4 PRONGS	5 1/2
BV094R	SEMI-S	3 x 4 PRONGS	6 1/2



BABY ADSON RETRACTOR, ANGLED

Catalog Number	Tip	Blade End	Length (in.)
MG007R	BLUNT	4 x 4 PRONGS	7 1/2

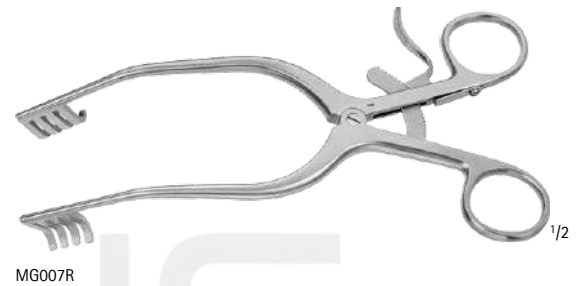

WEITLANER RETRACTOR

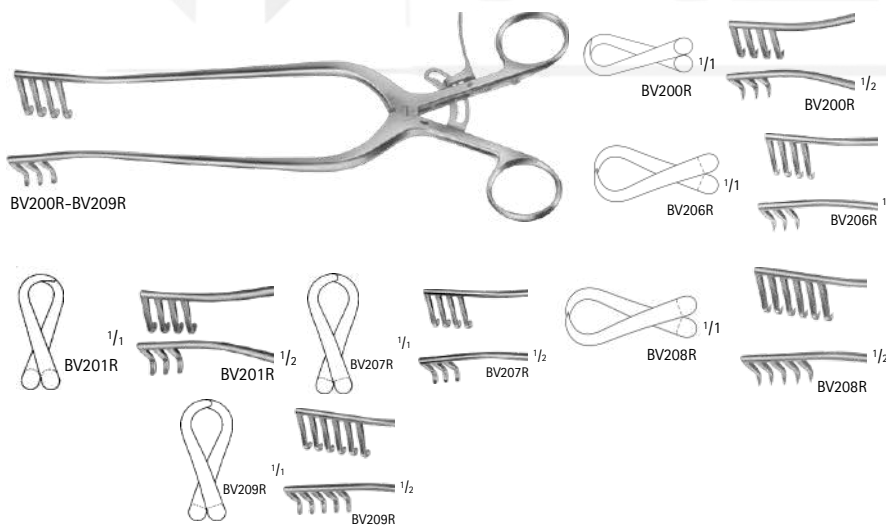

Catalog Number	Tip	Blade End	Length (in.)
BV200R	SHARP	3 x 4 PRONGS	7 7/8
BV206R	SHARP	3 x 4 PRONGS	9 1/2
BV208R	SHARP	5 x 6 PRONGS	10
BV201R	BLUNT	3 x 4 PRONGS	7 7/8
BV207R	BLUNT	3 x 4 PRONGS	9 1/2
BV209R	BLUNT	5 x 6 PRONGS	10

MISKIMON CEREBELLAR RETRACTOR

Catalog Number	Tip	Blade End	Length (in.)
MB476R	SHARP	7 x 7 PRONGS	7 7/8



GENERAL SURGERY

Self Retaining Retractors

THYROID RETRACTOR

Catalog Number
BV086R

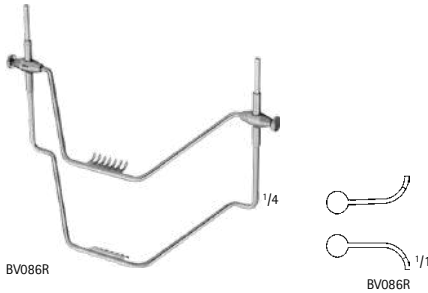

JOLL (FRIEDMANN) THYROID/VAGINAL RETRACTOR

Catalog Number	Length (in.)
BV087R	6 1/8

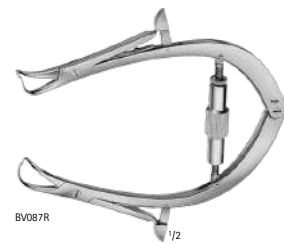

MAYO-ADAMS RETRACTOR

Catalog Number	Length (in.)
BV112R	6 1/2



MOLLISON RETRACTOR

Catalog Number	Tip	Blade End	Length (in.)
BV088R	SHARP	4 x 4 PRONGS	6 1/8

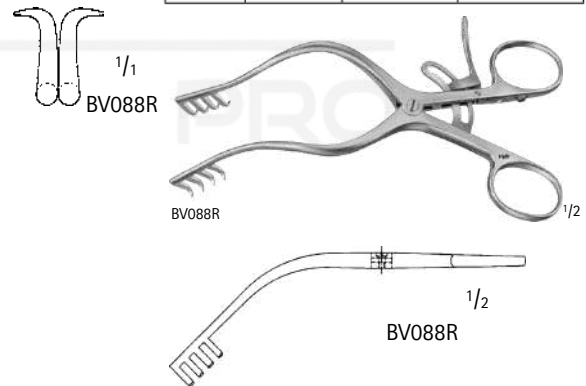

WILSTE-GELPI RETRACTOR

Catalog Number	Tip	Tip Size (mm)	Length (in.)
MB929R	SHARP	70	11

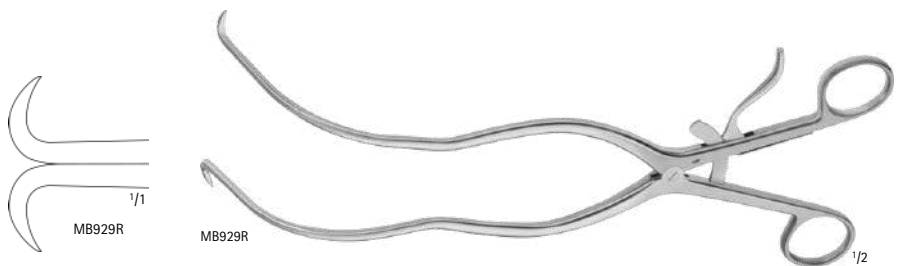

GENERAL SURGERY

Self Retaining Retractors

GELPI PERINEAL RETRACTOR

Catalog Number	Tip	Length (in.)
MB199R	SHARP WITH BALL STOPS	7

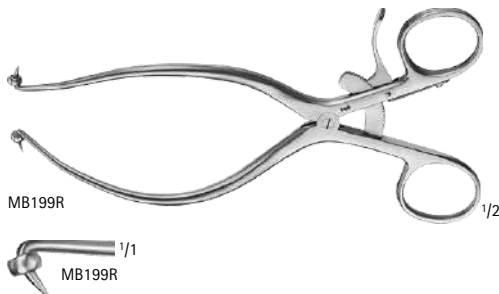

GELPI VAGINAL RETRACTOR

Catalog Number	Tip	Length (in.)
MG176R	SHARP	3 1/2
BV996R	SHARP	5 1/4
BV997R	SHARP	6 7/8
MD651	SHARP	7 1/4
MG177R	BLUNT	4 1/2

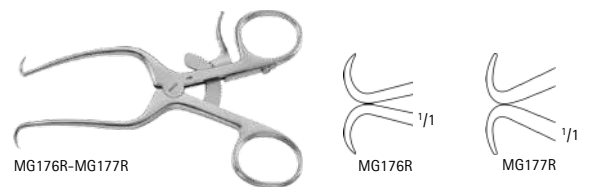

DEBAKEY FEMUR RETRACTOR FOR CHILDREN

Catalog Number	Tip	Length (in.)
BV998R	SHARP	4

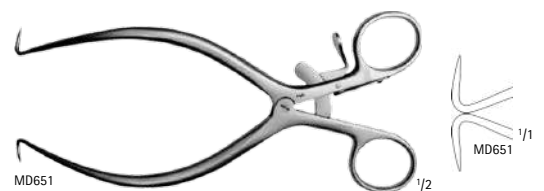
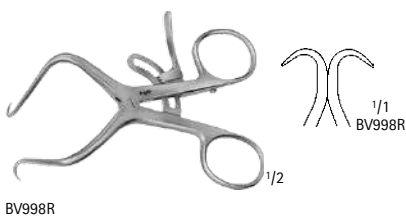

DEBAKEY FEMUR RETRACTOR FOR ADULTS

Catalog Number	Tip	Length (in.)
BV999R	SHARP	5 1/2

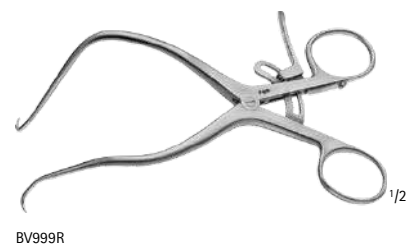
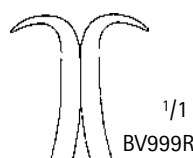

GENERAL SURGERY

Self Retaining Retractors

JACKSON-BURROWS RETRACTOR

Catalog Number	Tip	Length (in.)
BV993R	BLUNT	7

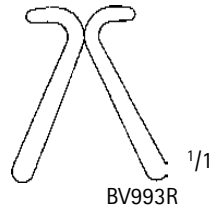

HENLY RETRACTOR

Catalog Number	Description	Blade Size (mm)	Blade Size (in.)	Length (in.)
BV120R	COMPLETE SET	-	-	7
MB842R	CENTER BLADE, SMALL	19 x 16	3/4 x 5/8	-
MB843R	CENTER BLADE, MEDIUM	25 x 16	1 x 5/8	-
MB844R	CENTER BLADE, LARGE	32 x 16	1 1/4 x 5/8	-
MB848R	CENTER BLADE, X-LARGE	76 x 16	3 x 5/8	-
MB845R	SIDE BLADE, PAIR (4 PRONGS)	25 x 25	1 x 1	-
MB846R	SIDE BLADE, PAIR (4 PRONGS)	51 x 25	2 x 1	-
MB847R	SIDE BLADE, PAIR (4 PRONGS)	76 x 22	3 x 1	-
MB849R	FRAME ONLY			7

BV120R Complete Set Includes:

- 1 Frame,
 - 1 each of 4 Center Blades,
 - 1 Pair of each of 3 Side Blades
- Materials in set sold separately: MB842R-MB849R

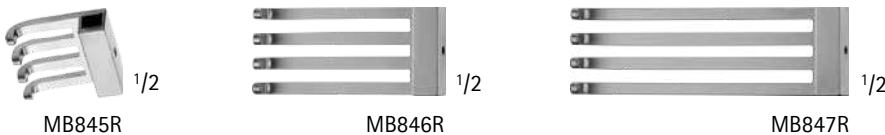
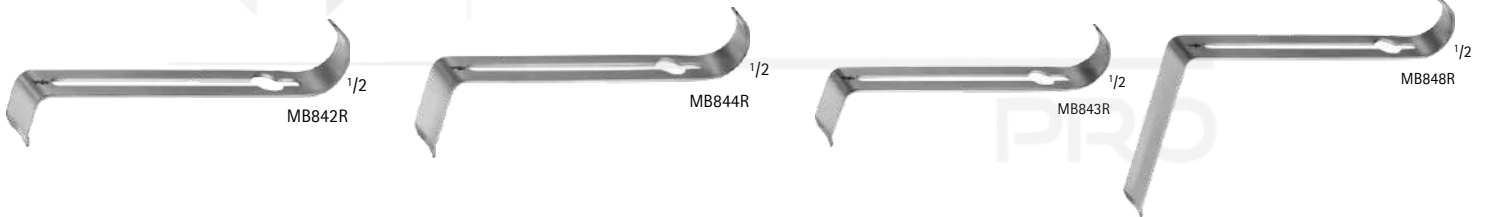
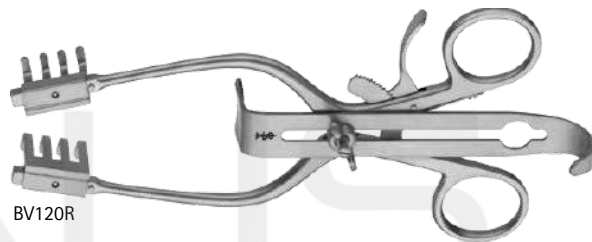

GENERAL SURGERY

Rectal Specula Instruments

PARKS RECTAL SPREADER

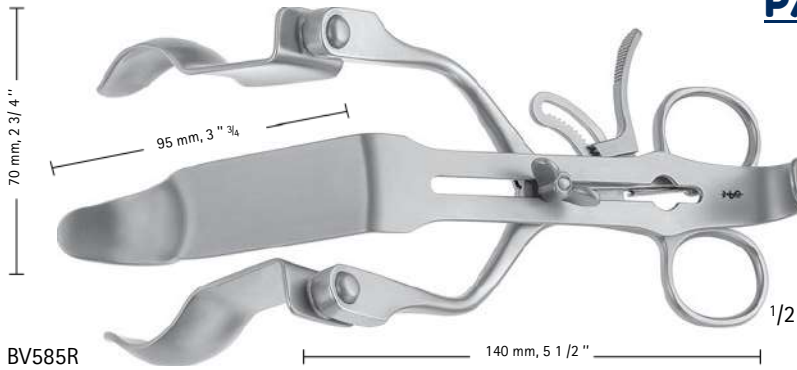

Catalog Number	Item	Length (mm)
BV585R	COMPLETE SET	-
BV581R	SPREADER ONLY	-
BV582R	CENTER BLADE	70
BV583R	SIDE BLADE, PAIR	90
BV586R	SIDE BLADE, PAIR	93
BV584R	SIDE BLADE, PAIR	150
BV589R	SIDE BLADE, PAIR	

Set Includes:

- 1 Spreader BV581R
- 1 Center Blade BV582R
- 2 Blades of each BV583R and BV584R

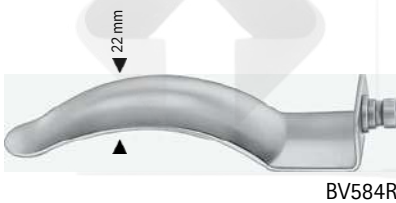
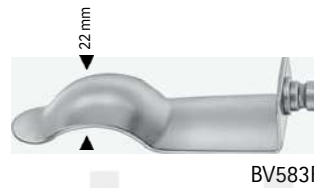
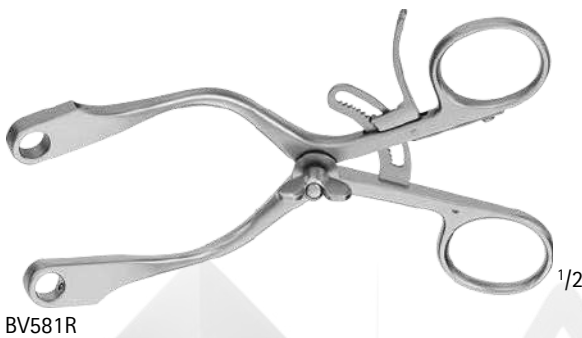

SMITH-BUIE RECTAL RETRACTOR

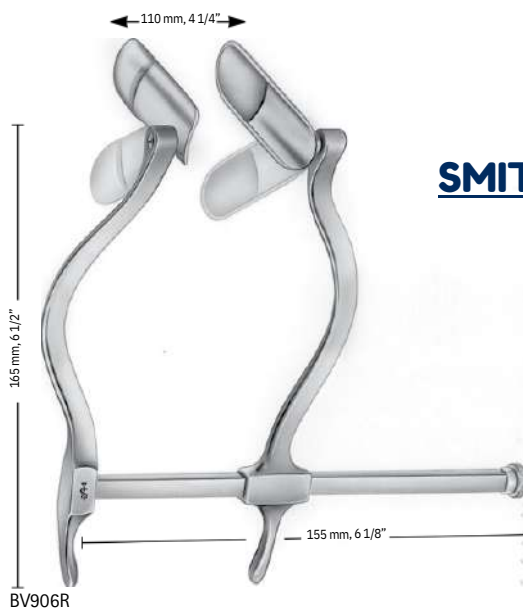

Catalog Number	Blade Size (mm)
BV906R	58 x 23

GENERAL SURGERY

Rectal Specula Instruments

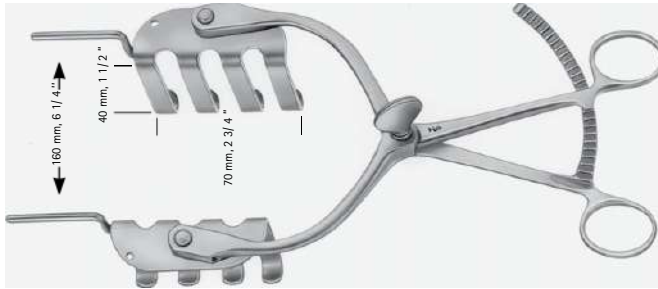

BV907R 210 mm, 8 1/4"

ST. MARKS MODIFIED GIRONA PERINEAL RETRACTOR

Catalog Number
BV907R



EA800R

CZERNY RECTAL SPECULUM

Catalog Number	Length (in.)
EA800R	8 7/8



MB772R-MG178R

SAWYER RETRACTOR

Catalog Number	Size	Blade Size (mm)	Length (in.)
MB773R	SMALL	70 x 19	10 3/4
MB772R	MEDIUM	82 x 29	10 3/4
MG178R	LARGE	97 x 38	11 5/8



MB774R-MB776R

HILL-FERGUSSON RECTAL RETRACTOR

Catalog Number	Blade Size (mm)	Length (in.)
MB775R	64 x 24	8 1/4
MB774R	76 x 35	8 1/4
MB776R	76 x 32	8 1/4

GENERAL SURGERY

Rectal Specula Instruments

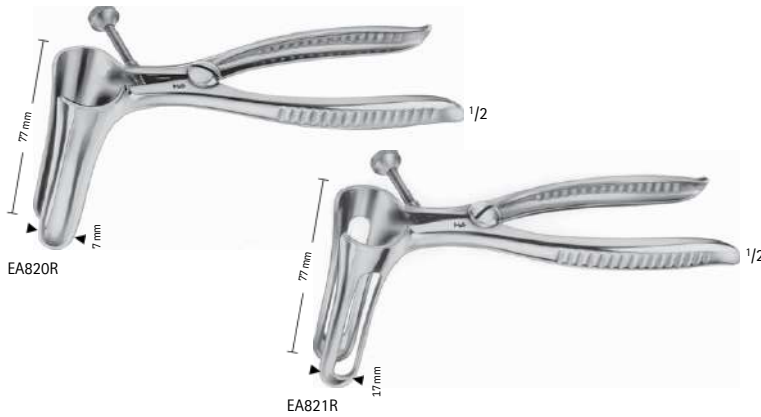

SIMS RECTAL SPECULUM

Catalog Number	Blade	Length (in.)
EA820R	SOLID	6 1/4
EA821R	FENESTRATED	6 1/4

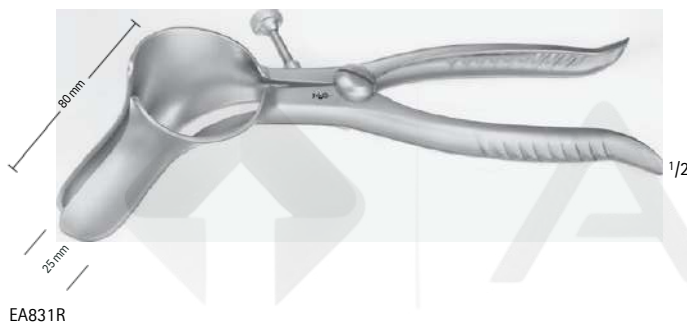

PRATT RECTAL SPECULUM

Catalog Number	Length (in.)
EA831R	8

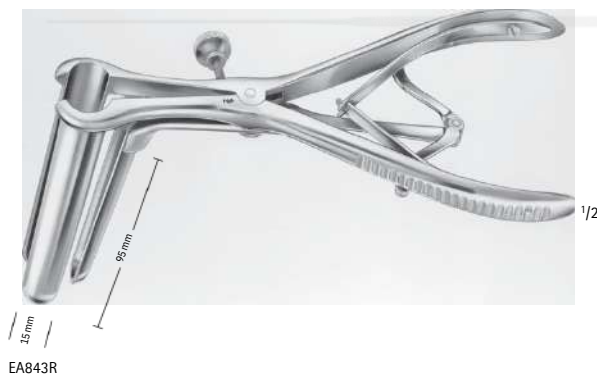

MATHIEU RECTAL SPECULUM

Catalog Number	Length (in.)
EA843R	8 1/2



IVES-FANSLER ANUSCOPE

Catalog Number	Length (in.)
EA880R	5 3/4

GENERAL SURGERY

Rectal Specula Instruments

RECTAL SPECULUM

Catalog Number	Length (in.)
MB274R	2 3/8



MB274R

HIRSCHMANN RECTAL SPECULUM

Catalog Number	Size	Blade Size (mm)
MB203R	SMALL	60 x 16
MB288R	MEDIUM	72 x 19
MB179R	LARGE	89 x 23



MB179R, MB203R, MB288R

CHELSEA-EATON ANAL SPECULUM

Catalog Number	Size	Diameter (mm)	Finish	Length (in.)
MG160R	SMALL	30	MIRROR FINISH	2 1/2



MG160R

BRINKERHOFF RECTAL SPECULUM

Catalog Number	Size	Diameter (in.)	Length (in.)
MG162R	SMALL	1/2 x 1	3 3/4
MG163R	MEDIUM	5/8 x 1	3 3/4
MB284R	LARGE	3/4 x 1 1/4	4 1/2



MB284R, MG162R-MG163R

KELLY SPHINCTEROSCOPE

Catalog Number	Diameter (mm)	Working Length (mm)	Length (in.)
EA882R	21	54	6 1/4
EA887R	22	140	5 1/2
EA883R	25	50	6 1/4



EA882R-EA887R

MCGIVNEY HEMORRHOIDAL FORCEPS

Catalog Number	Length (in.)
EA990R	7 1/4

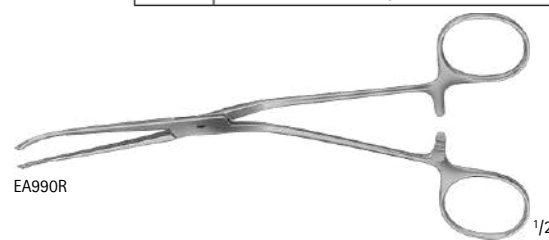

EA990R

GENERAL SURGERY

Rectal Specula Instruments

RUDD HEMORRHOIDAL LIGATOR

Catalog Number	Description	Length (in.)
EA991R	COMPLETE SET	12 3/8
EA992R	LIGATOR, INCLUDES CONE	12 1/2
EA992208	LIGATOR CONE ONLY	-
EA993	LATEX FREE RINGS F/ EA991R, 100/PKG	-

EA991R Complete Set Includes:
EA992R and EA993



STEWART CRYPT HOOK

Catalog Number	Length (in.)
MB892R	9

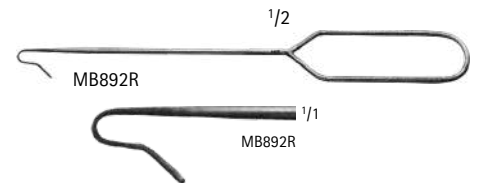

GENERAL SURGERY

Probes, Dilators and Scoops

BAKES BILE-DUCT DILATOR

Catalog Number	Tip Size (mm)	Length (in.)
EB061R	1	12 3/8
EB062R	2	12 3/8
EB063R	3	12 3/8
EB064R	4	12 3/8
EB065R	5	12 3/8
EB066R	6	12 1/2
EB067R	7	12 1/2
EB068R	8	12 1/2
EB069R	9	12 1/2
EB070R	10	12 1/2
EB071R	11	12 1/2
EB072R	12	12 1/2
EB073R	13	12 1/2
EB074R	SET, 3-11 mm	-

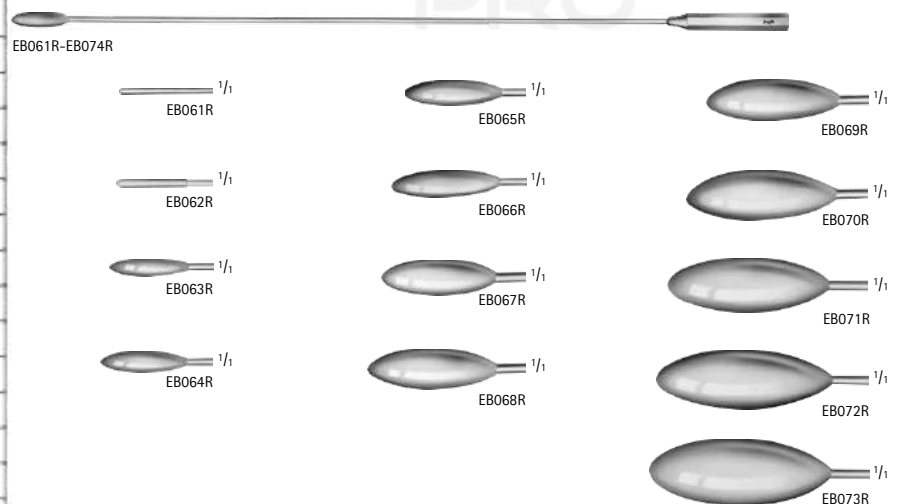

GENERAL SURGERY

Probes, Dilators and Scoops

LUER-KOERTE SCOOPS, MALLEABLE SHAFT

Catalog Number	Tip Size (mm)	Length (in.)
EB168R	2.8	12 3/4
EB169R	3.4	12 3/4
EB170R	4.3	12 3/4
EB171R	5.5	12 3/4
EB172R	6.7	12 3/4
EB173R	8.0	12 3/4
EB174R	11.0	12 3/4
EB175R	15.0	12 3/4



EB168R-EB175R

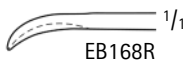

EB168R



EB169R



EB170R



EB171R



EB172R



EB173R



EB174R



EB175R

DIRECTOR W/ TONGUE

Catalog Number	Blade Shape	Length (in.)
BN003R	STR	5 1/8
BN004R	STR	5 3/4
BN006R	STR	6 1/4



BN003R-BN006R



BN003R-BN006R

DOYEN DIRECTOR W/ TONGUE

Catalog Number	Blade Shape	Length (in.)
BN010R	CVD	5 3/4



BN010R



BN010R

GROOVED DIRECTOR W/ TONGUE

Catalog Number	Length (in.)
MB336R	4 1/2



MB336R

NELATON DIRECTOR

Catalog Number	Blade Shape	Length (in.)
BN012R	CVD	6 1/4



BN012R



BN012R

GENERAL SURGERY

Probes, Dilators and Scoops

DIRECTOR, W/ PROBE TIP & TONGUE

Catalog Number	Diam. of Tip (mm)	Blade Shape	Length (in.)
BN015R	3.3	STR	5 1/2

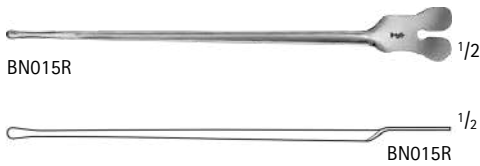

BRODIE DIRECTOR, W/ PROBE TIP & TONGUE

Catalog Number	Diam. of Tip (mm)	Blade Shape	Length (in.)
BN020R	3.5	STR	7 7/8

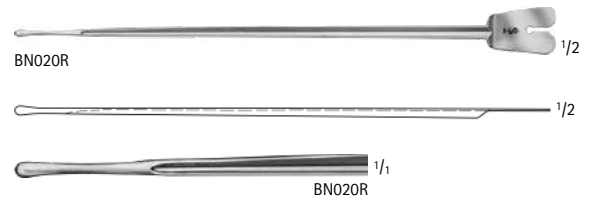

PROBE

Catalog Number	Diam. of Tip (mm)	Length (in.)
BN170R	1.4	6 1/4



LOCKHART-MUMMERY FISTULA PROBE

Catalog Number	Blade Shape	Length (in.)
BN021R	#1-STR	6 1/2
BN022R	#2-SLT-CVD	6 1/2
BN023R	#3-CVD	6 1/2
BN024R	#4-HVY-CVD	6 1/2

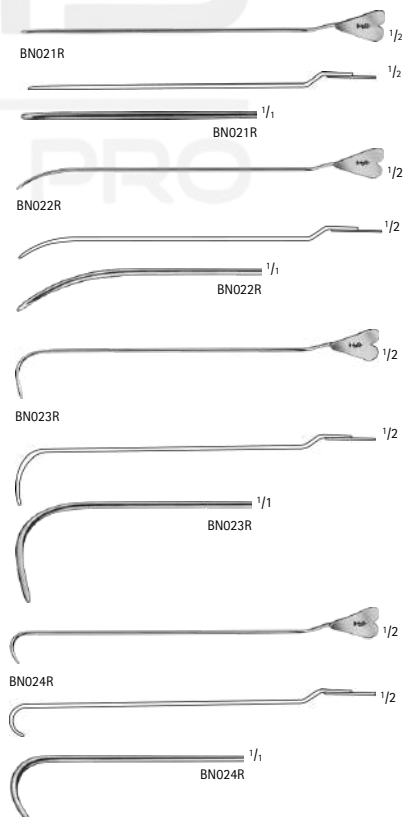

BUIE FISTULA PROBE

Catalog Number	Description	Length (in.)
MG168R	LIGHT	6 1/2
MG169R	HEAVY	6 1/2



PROBE W/ EYE

Catalog Number	Tip Size (mm)	Length (in.)
MB603R	1.5	5
BN034R	2.5	5 3/4
BN036R	2.5	6 1/4
BN040R	3	7 7/8



GENERAL SURGERY

Probes, Dilators and Scoops

PROBE W/ EYE, SILVER

Catalog Number	Tip Size (mm)	Length (in.)
MG571	1.75	4 1/2



MG571

DOUBLE ENDED PROBE W/ EYE, MALLEABLE

Catalog Number	Tip Size (mm)	Length (in.)
BN090R	3.0	7 1/2
BN095	3.5	9 3/4
BN096	3.5	11 3/4



BN090R



BN095-BN096

PRATT RECTAL PROBE, MALLEABLE

Catalog Number	Tip Size (mm)	Length (in.)
MB486	2.0	10



MB486

PROBE

Catalog Number	Tip Size (mm)	Length (in.)
BN101R	2.0	11 3/4



BN101R



MB697R-MB699R



1/1



MB697R-MB699R

MYRTLE LEAF PROBE

Catalog Number	Tip Size (mm)	Length (in.)
BN054R	1.5	5 3/4
BN063R	2	5 1/8
BN064R	2	5 3/4
BN066R	2	6 1/4
BN068R	2	7
BN070R	2	7 7/8



BN054R



BN063R-BN070R

DOUBLE ENDED PROBE

Catalog Number	Tip Size (mm)	Length (in.)
BN104R	1.0	5 3/4
BN113R	1.5	5 1/8
BN114R	1.5	5 3/4
BN116R	1.5	6 1/4
BN118R	1.5	7
BN120R	1.5	7 7/8
BN125R	1.5	9 3/4
BN134R	2.0	5 3/4
BN136R	2.0	6 1/4
BN138R	2.0	7
BN140R	2.0	7 7/8
BN150R	2.0	11 3/4

BN104R-BN150R

FERGUSSON GALL STONE SCOOP, DOUBLE ENDED

Catalog Number	Size	Length (in.)
MB697R	SMALL	9 1/2
MB698R	MEDIUM	9 1/2
MB699R	LARGE	9 1/2

GENERAL SURGERY

Probes, Dilators and Scoops

BARR FISTULA PROBE, DOUBLE ENDED

Catalog Number	Length (in.)
MG170R	6 5/8



PRATT FISTULA PROBE, CRYPT HOOK

Catalog Number	Length (in.)
EA890R	9 1/2



ROSSER CRYPT HOOK

Catalog Number	Length (in.)
MG165R	6 5/8

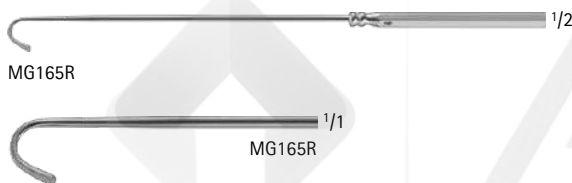

DESJARDINS GALL DUCT PROBE, FLEXIBLE

Catalog Number	Tip Size (mm)	Length (in.)
EB101R	3.8	11 1/4
EB102R	4.3	11 1/4
EB103R	6.8	11 1/4

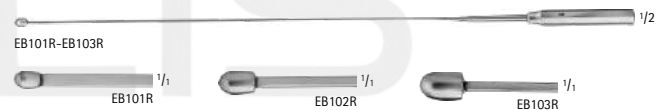

DESJARDINS GALL STONE SCOOP

Catalog Number	Tip Size (mm)	Length (in.)
EB111R	6	11 3/4
EB112R	7	11 3/4
EB113R	8	11 3/4
EB114R	9	11 3/4

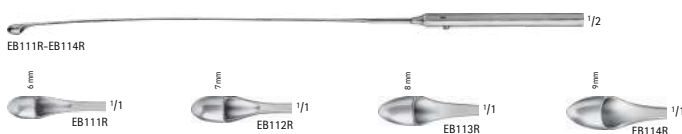

MAYO GALL DUCT PROBE

Catalog Number	Tip Size (mm)	Tip	Length (in.)
E0005R	5	MALLEABLE	13



GENERAL SURGERY

Scalpel Handles

MICRO SCALPEL HANDLE

MB475R

Replacement collet for MB104R, MB141R, MB271R, MB280R, MB281R and MB997R

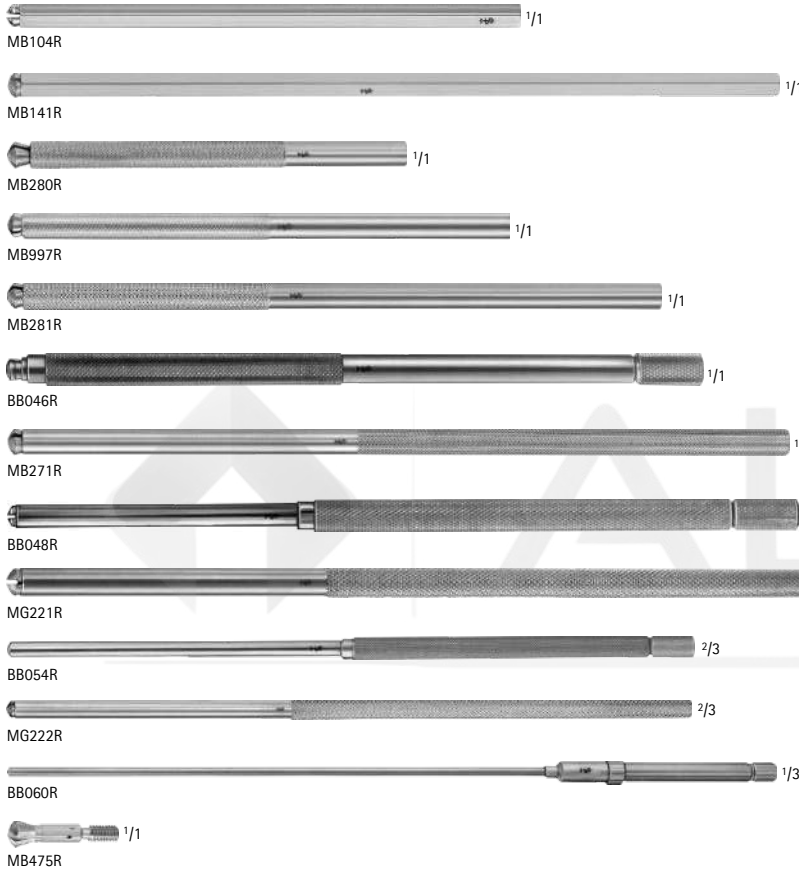

Catalog Number	Size	Length (in.)	Handle
MB104R	3H	4	Hexagonal
MB141R	3HL	6	Hexagonal
MB280R	3KM	3	Round Knurled
MB997R	3K	4	Round Knurled
MB281R	3KD	5	Round Knurled
BB046R	3K	5 1/4	Round Knurled
MB271R	3KL	6	Round Knurled
BB048R	3KL	6 1/8	Round Knurled
MG221R	3	7	Round Knurled
BB054R	3	7 7/8	Round Knurled
MG222R	3	8	Round Knurled
BB060R	3	17 3/4	Round Knurled
MB475R	COLLET		

CORWIN KNIFE HANDLE

Catalog Number	Length (in.)
MA203R	5 1/2

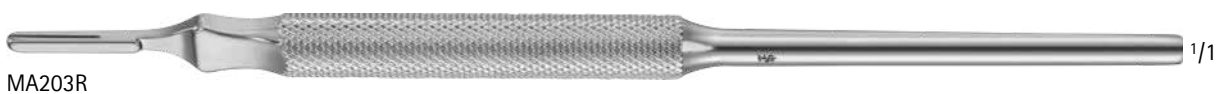

CASPAR SCALPEL HANDLE

Catalog Number	Length (in.)
BB052R	7



LANDOLT SCALPEL HANDLE, F/ MICROSURGERY BLADES

Catalog Number	Length (in.)
BB053R	8 1/4
BB057R	9 3/4

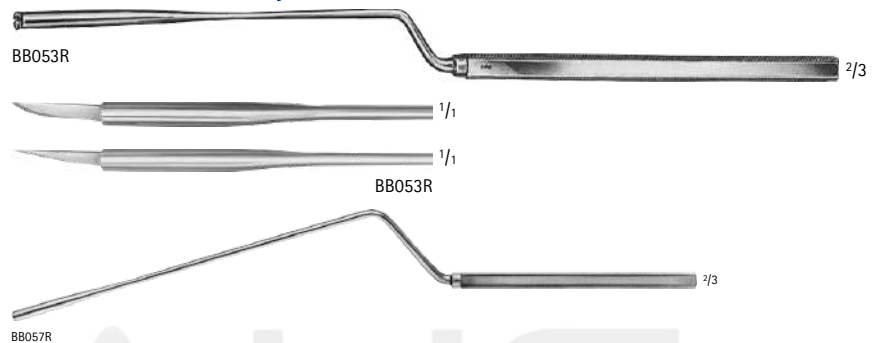

YASARGIL ARACHNOID BLADES F/ LANDOLT SCALPEL HANDLES

Catalog Number	Tip Size (mm)	Packaging
BB331R	1.5	10/BOX
BB332R	2.5	10/BOX

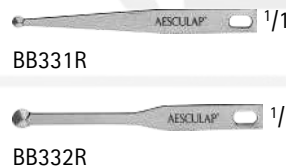

TRANSSPHENOIDAL SCALPEL HANDLE, BAYONET, F/ VERTICAL AND LATERAL BLADES

Catalog Number	Length (in.)
BB071R	8 1/4



STERILE MICROSURGERY BLADES

Catalog Number	Tip	Packaging
BB361R	SMALL CHISEL #61	10/BOX
BB362R	WIDE CHISEL #62	10/BOX
BB363R	SPEAR #63	1 EACH
BB364R	ROUND #64	10/BOX
BB365R	SMALL, SHARP #65	10/BOX
BB367R	CURVED, POINTED #67	10/BOX
BB368R	SMALL SICKLE #68	10/BOX



BARRON SCALPEL HANDLE #3 F/ BLADES NOS. 10-15, 40, 42

Catalog Number	Length (in.)
BB068R	5 1/8



SCALPEL HANDLE #3, F/ BLADES NOS. 10-15, 40, 42

Catalog Number	Length (in.)
BB070R	6 1/8



SCALPEL HANDLE #3, F/ BLADES NOS. 10-15, 40, 42

Catalog Number	Size	Length (in.)
BB074R	#3	5
BB075R	#3L	8 1/4
BB175R	#3XL	9 3/4
MB917R	#3	16



Scalpel Handles

SCALPEL HANDLE #3L, F/ BLADES NOS. 10-15, 40, 42

Catalog Number	Blade Shape	Length (in.)
MB127R	ANG	8



SCALPEL X-LONG HANDLE, #3, F/ BLADES NOS. 10-15, 40, 42

Catalog Number	Blade Shape	Length (in.)
BB078R	STR	8 7/8



SCALPEL X-LONG HANDLE, #3, F/ BLADES NOS. 10-15, 40, 42

Catalog Number	Blade Shape	Length (in.)
BB079R	ANG	8 7/8



SCALPEL HANDLE #4, F/ BLADE NOS. 18-36

Catalog Number	Length (in.)
BB080R	8 7/8



SCALPEL HANDLE #4, F/ BLADES NOS. 18-36

Catalog Number	Length (in.)
BB084R	5 1/4



SCALPEL HANDLE #4L, F/ BLADES NOS. 18-36

Scalpel Handle #4L, F/ Blades nos. 18-36

Catalog Number	Length (in.)
BB085R	8 1/2



GENERAL SURGERY

Scalpel Blades

SCALPEL HANDLE #4XL, F/ BLADES NOS. 18-36

Catalog Number	Length (in.)
BB087R	9 3/4



SCALPEL HANDLE #7, F/ BLADES NOS. 10-15, 40, 42

Catalog Number	Length (in.)
BB077R	6 1/4



SCALPEL HANDLE #9XL, F/ BLADES NOS. 18-36

Catalog Number	Length (in.)
MA202R	4 5/8 5
BB089R	3/4



STERILE SCALPEL BLADE, FOR #3 HANDLE

Catalog Number		Blade Number	Packaging
Carbon	Stainless Steel		
BB510	16600495	#10	100/BOX
BB511	16600509	#11	100/BOX
BB512	16600517	#12	100/BOX
BB515	16600525	#15	100/BOX
BB540	-	#40	100/BOX
BB542	-	#42	100/BOX



BB510, 16600495



BB515, 16600525



BB511, 16600509



BB540 double cutting



BB512, 16600517



BB542 double cutting

GENERAL SURGERY

Scalpel Blades



STERILE SCALPEL BLADE, FOR #4 HANDLE

Catalog Number		Blade Number	Packaging
Carbon	Stainless Steel		
BB520	16600550	#20	100/BOX
BB521	16600568	#21	100/BOX
BB522	16600576	#22	100/BOX
BB523	16600584	#23	100/BOX
BB524	16600592	#24	100/BOX
BB525	16616634	#25	100/BOX
BB536	16615522	#36	100/BOX

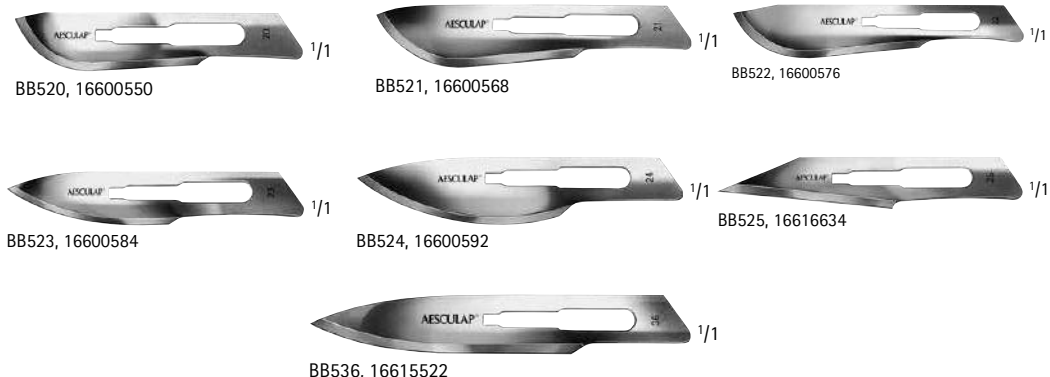

STERILE STITCH CUTTER BLADE #3 HANDLE

Catalog Number		Packaging
Carbon	Stainless Steel	
BB500	16600487	100/BOX



GENERAL SURGERY

Sterile Scalpels With Plastic Handle

STERILE SCALPELS W/ PLASTIC HANDLE AND BLADE PROTECTOR

Catalog Number		Size	Packaging
Carbon	Stainless Steel		
BA210	5518059	10	10/BOX
BA211	5518040	11	10/BOX
BA212	5518105	12	10/BOX
BA215	5518032	15	10/BOX
BA218	-	18	10/BOX
BA219	-	19	10/BOX
BA220	5518067	20	10/BOX
BA221	5518075	21	10/BOX
BA222	5518083	22	10/BOX
BA223	5518016	23	10/BOX
BA224	5518091	24	10/BOX

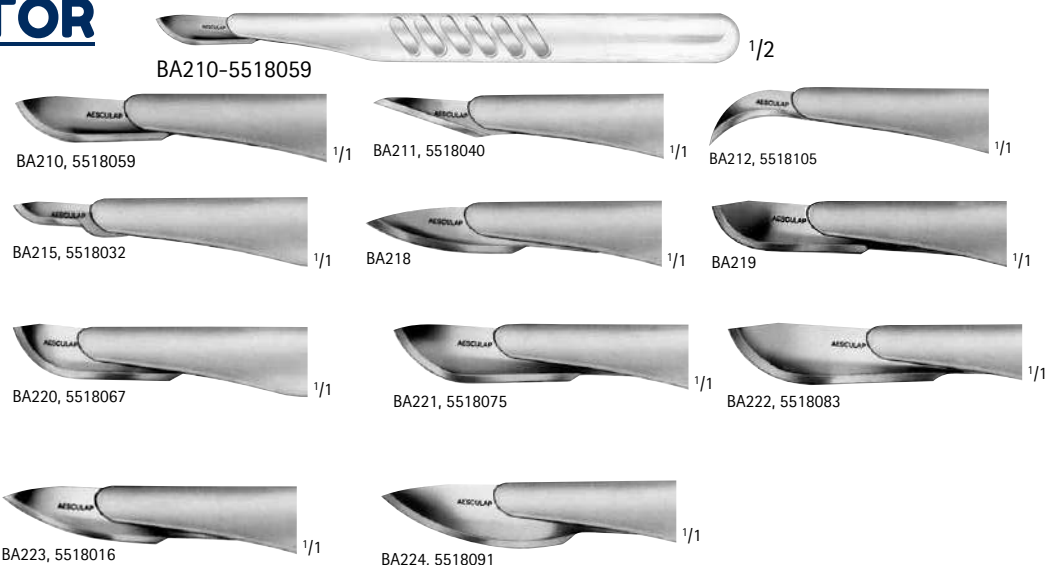

GENERAL SURGERY

Amputation and Autopsy Instruments

LISTON AMPUTATING KNIFE

Catalog Number	Blade Length (mm)	Blade Size (in.)
FH100R	130	5 1/8
FH101R	160	6 1/4
FH102R	190	7 1/2
FH103R	220	8 3/4



FH100R-FH103R

CATLIN AMPUTATING KNIFE, DOUBLE CUTTING

Catalog Number	Blade Length (mm)	Blade Size (in.)
FH116R	160	6 1/4



FH116R

CHARRIÈRE AMPUTATION SAW, 2 BLADES

Catalog Number	Item	Blade Size (in.)	Blade Width (mm)	Total Length (in.)
FH300R	SAW COMPLETE W/2 BLADES	8 1/2	-	14
FH301C	CARBON STEEL BLADE	8 1/2	12	-
FH302C	CARBON STEEL BLADE	8 1/2	18	-



FH300R



FH301C-FH302C

CHARRIÈRE AMPUTATION SAW

Catalog Number	Item	Blade Size (in.)	Total Length (in.)
FH320R	SAW COMPLETE	7 1/4	10 1/2

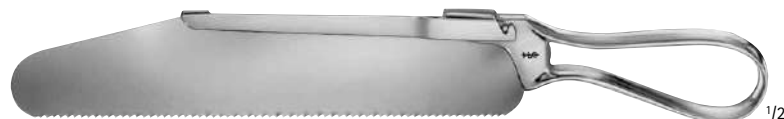

FH320R

GENERAL SURGERY

Amputation and Autopsy Instruments

LANGENBECK METACARPAL SAW

Catalog Number	Length (in.)
FH335R	9 1/4



GIGLI WIRE SAW

Catalog Number	Diameter (mm)	Wires	Sales Unit	Length (in.)
FH414	1.4	6	BOX OF 5	15 3/4
FH415	1.4	6	BOX OF 5	19 3/4
FH430R	1.8	4	BOX OF 5	19 3/4

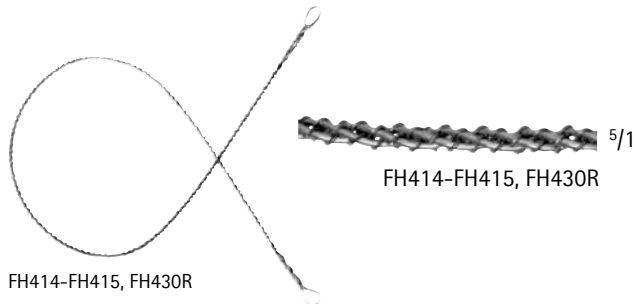

GIGLI SAW HANDLE

Catalog Number	Packaging
MB986R	2/SET



GIGLI HOOK HANDLE, F/ WIRE SAWS

Catalog Number	Packaging
FH480R	2/SET



SATTERLEE AMPUTATION SAW

Catalog Number	Item	Total Length (in.)
FH325R	SAW COMPLETE	11 1/2
FH326R	CARBON STEEL BLADE F/ FH325R	-



GENERAL SURGERY

Suction Tubes

POOLE SUCTION TUBE

Catalog Number	Handle	Tip Size (FR)	Hole in Tip Inner/Outer	Tube Diameter Inner/Outer	Length (in.)
MG272R	STR	30	YES/YES	5 mm/10 mm	8 1/2
GF862R	STR	30	YES/NO	5 mm/10 mm	8 7/8
MB927R	STR	30	YES/YES	4 mm/10 mm	14
MB928R	STR	30	YES/YES	4 mm/10 mm	16
MG271R	CVD	24	YES/NO	4 mm/8 mm	8 3/4
GF860R	CVD	21	YES/YES	4 mm/8 mm	8 7/8



MG272R



GF862R



MB927R-MB928R



MB927R



MB928R



MG271R



GF860R

ADSON SUCTION TUBE

Catalog Number	Tip Size (mm)	Tip Size (FR)	Length (in.)
GF917R	4	11	7 1/2



Diam. 4 mm

Olive Diam. 9 mm

GF917R

NASAL SUCTION TUBE W/ LUER HUB,

TAPERED

Catalog Number	Tip Size (mm)	Length (in.)
GF919R	5	7



Olive Diam. 6 - 9 mm

GF919R

GENERAL SURGERY

Suction Tubes

COOLEY SUCTION TUBE W/ DETACHABLE TIP

Catalog Number	Tip Size (mm)	Shaft	Length (in.)
GF822R	8.0	SLT-CVD	12 1/4
GF823R	9.0	CVD	11 5/8
GF824R	8.0	ANG	12 1/2
GF825R	9.0	90°	10 1/2

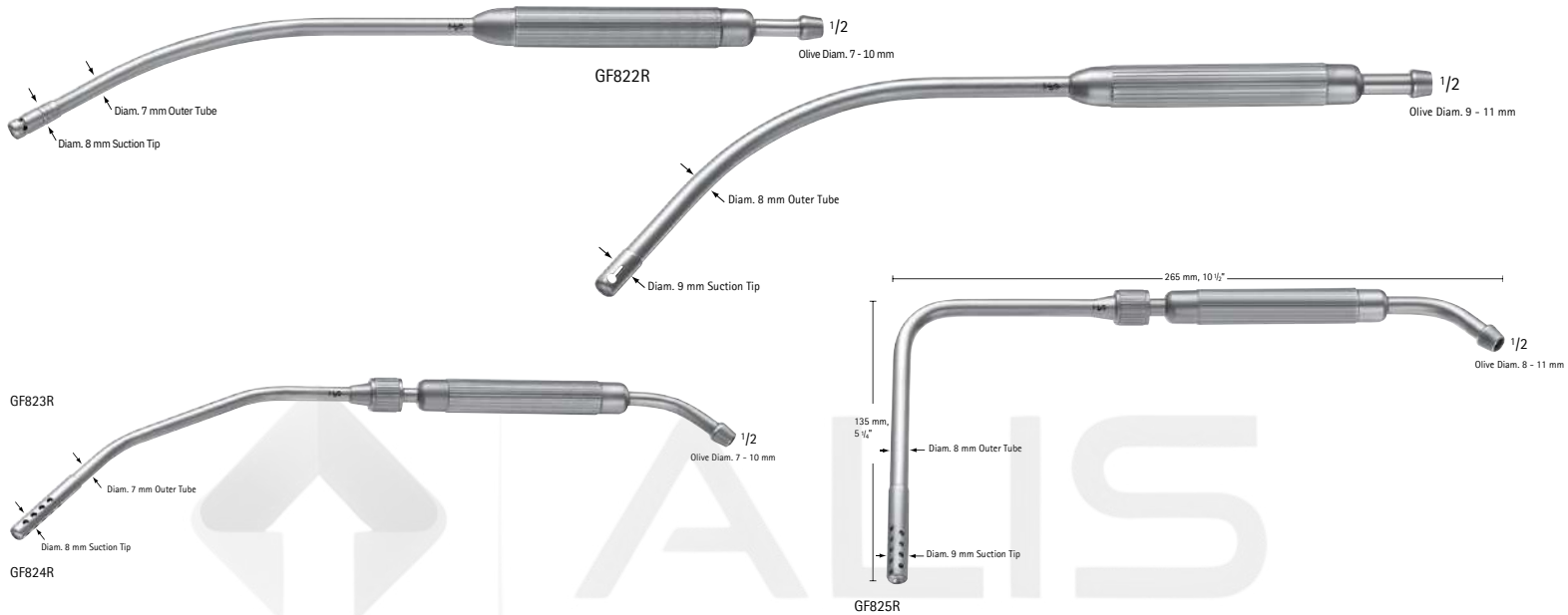

COOLEY SUCTION TUBE

Catalog Number	Tip Size (mm)	Length (in.)
GF821R	8.0	13 1/4



GRAFTING SUCTION TUBE

Catalog Number	Tip Size (mm)	Length (in.)
MB286R	3	9 1/2
MB287R	4	9 1/2



GENERAL SURGERY

Suction Tubes

DEBAKEY SUCTION TUBE

Catalog Number	Tip Size (mm)	Length (in.)
GF946R	3	10 3/4
GF947R	5	6 1/4
GF948R	5	10 5/8
GF946205	REPLACEMENT TIP FOR GF946R	-



ATRAUMATIC SUCTION TUBE

Catalog Number	Tip Size (FR)	Working Length (in.)	Length (in.)
MF333R	3	3	6 1/4
MF334R	5	3	6 1/4
MF335R	7	3	6 1/4
MF336R	10	3	6 1/4
MF337R	12	3	6 1/4
MF338R	3	4	7 1/4
MF339R	5	4	7 1/4
MF340R	7	4	7 1/4
MF341R	10	4	7 1/4
MF342R	12	4	7 1/4
MF343R	3	5	8 1/4
MF344R	5	5	8 1/4
MF345R	7	5	8 1/4
MF346R	10	5	8 1/4
MF347R	12	5	8 1/4

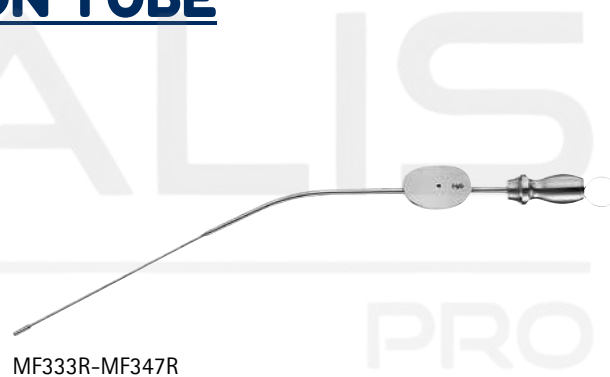

ATRAUMATIC SUCTION TUBE

Catalog Number	Tip	Tip Size (FR)	Length (in.)
MF106R	90° DOWN	5	8 1/2
MF107R	90° DOWN	7	8 1/2
MF108R	90° DOWN	10	8 1/2
MF109R	90° UP	5	8 1/2
MF110R	90° UP	7	8 1/2
MF111R	90° UP	10	8 1/2

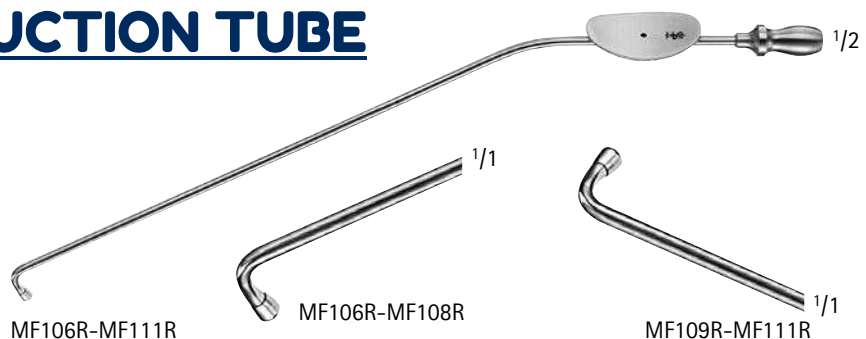

GENERAL SURGERY

Suction Tubes

YANKAUER SUCTION TUBE

Catalog Number	Description	Tip Opening (mm)	Length (in.)
GF944R	-	2.0	11 1/4
OM671R	-	4.8	11 1/4
MB919R	-	2.0	12
MG092R	W/ VALVE	2.0	13 1/4
MB051R	-	2.0	14
MB920R	W/ VALVE	2.0	16
GF944200	REPLACEMENT TIP F/ GF944R	-	-
OM671200	REPLACEMENT TIP F/ OM671R	-	-
MB051200	REPLACEMENT TIP F/ MB051R, MB053R, MG919R, MG920R	-	-
MG092200	REPLACEMENT TIP F/ MG092R	-	-

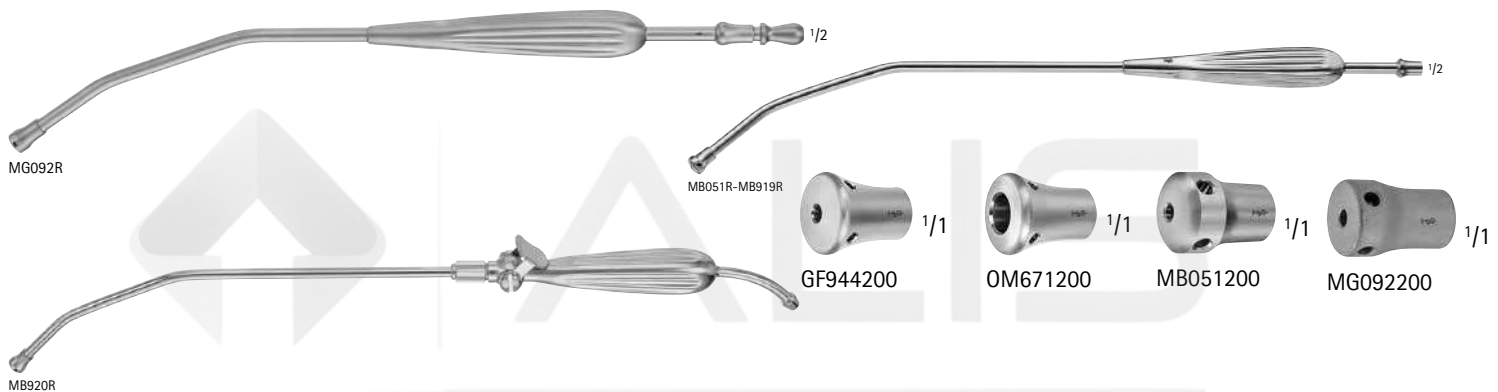

YANKAUER SUCTION W/ THUMB CONTROL

Catalog Number	Description	Length (in.)
MB052R	HANDLE W/ THUMB CONTROL	6 7/8
MB053R	SUCTION TUBE, CHROME PLATED	6 5/8



FERGUSON SUCTION TUBE

Catalog Number	Tip	Tip Size (mm)	Length (in.)
GF933R	ROUND	4	7



Suction Tubes

FERGUSSON SUCTION TUBE, LUER HUB

Catalog Number	Diameter (mm)	Working Length (in.)	Length (in.)
GF350R	1.5	4 1/4	7 3/4
GF351R	2.0	4 1/4	7 3/4
GF352R	2.5	4 1/4	7 3/4
GF353R	3.0	4 1/4	7 3/4
GF354R	4.0	4 1/4	7 3/4
GF355R	5.0	4 1/4	7 3/4
GF360R	1.5	5 1/8	8 1/2
GF361R	2.0	5 1/8	8 1/2
GF362R	2.5	5 1/8	8 1/2
GF363R	3.0	5 1/8	8 1/2
GF364R	4.0	5 1/8	8 1/2
GF365R	5.0	5 1/8	8 1/2
GF370R	1.5	6 1/4	9 5/8
GF371R	2.0	6 1/4	9 5/8
GF372R	2.5	6 1/4	9 5/8
GF373R	3.0	6 1/4	9 5/8
GF374R	4.0	6 1/4	9 5/8
GF375R	5.0	6 1/4	9 5/8
GF380R	1.5	7 7/8	11
GF381R	2.0	7 7/8	11
GF382R	2.5	7 7/8	11
GF383R	3.0	7 7/8	11
GF384R	4.0	7 7/8	11
GF385R	5.0	7 7/8	11

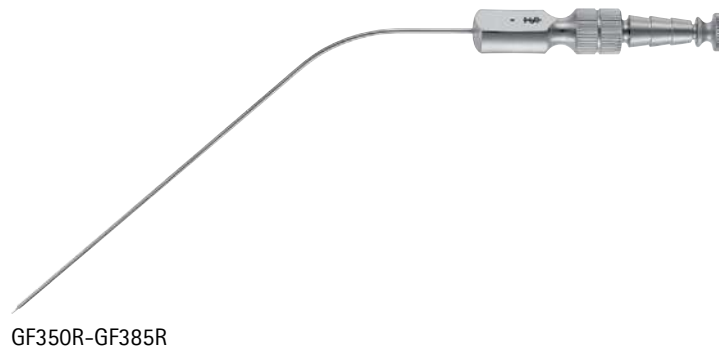

FRAZIER SUCTION TUBE

Catalog Number	Tip Size (FR)	Description	Working Length (in.)
MD124R	7		4 1/4
MD124300	7	SUCTION STYLET W/ OLIVE TIP FOR MD124R	
MD125R	7		4 1/4
MD125300	8	SUCTION STYLET W/ OLIVE TIP FOR MD125R	
MA501R	9		4 1/4
MA501300		SUCTION STYLET W/ OLIVE TIP FOR MA501R	
MD127R	10		4 1/4
MD127300	10	SUCTION STYLET W/ OLIVE TIP FOR MD127R	
MA499R	11		4 1/4
MA499300	11	SUCTION STYLET W/ OLIVE TIP FOR MA499R	
MD129R	12		4 1/4
MD129300	12	SUCTION STYLET W/ OLIVE TIP FOR MD129R	

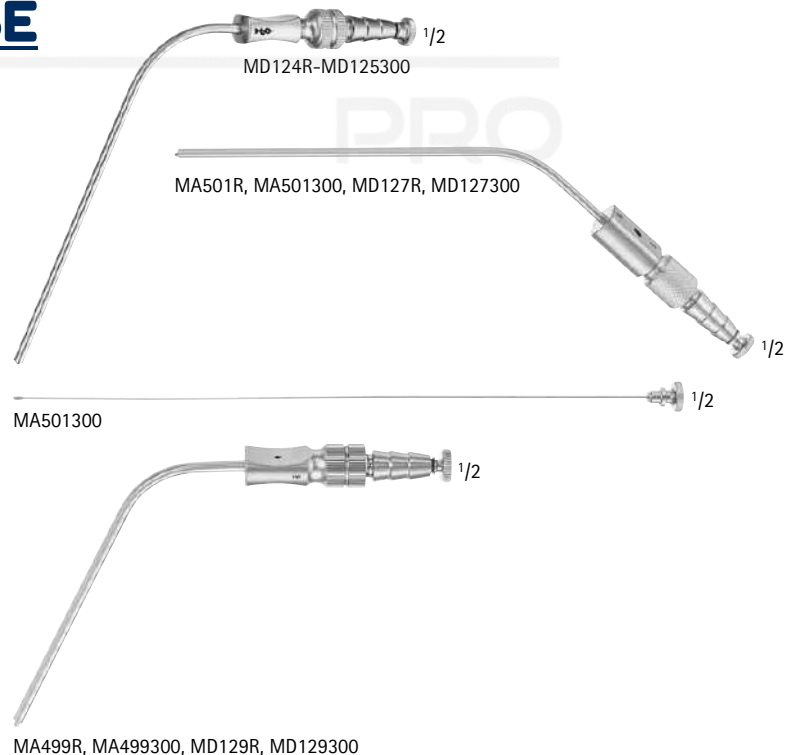

Suction Tubes

FRAZIER SLOTTED SUCTION TUBE

Catalog Number	Tip Size (FR)	Shaft	Length (in.)
MF479R	3	STR	5 1/2
MF480R	4	STR	5 1/2
MF481R	5	STR	5 1/2
MF482R	6	STR	5 1/2
MF483R	7	STR	5 1/2
MF484R	8	STR	5 1/2
MF485R	9	STR	5 1/2
MF486R	10	STR	5 1/2
MF487R	11	STR	5 1/2
MF488R	12	STR	5 1/2
MF499R	3	STR	7
MF500R	4	STR	7
MF501R	5	STR	7
MF502R	6	STR	7
MF503R	7	STR	7
MF504R	8	STR	7
MF505R	9	STR	7
MF506R	10	STR	7
MF507R	11	STR	7
MF508R	12	STR	7
MF489R	3	ANG	5 1/2
MF490R	4	ANG	5 1/2
MF491R	5	ANG	5 1/2
MF492R	6	ANG	5 1/2
MF493R	7	ANG	5 1/2
MF494R	8	ANG	5 1/2
MF495R	9	ANG	5 1/2
MF496R	10	ANG	5 1/2
MF497R	11	ANG	5 1/2
MF498R	12	ANG	5 1/2
MF509R	3	ANG	7
MF510R	4	ANG	7
MF511R	5	ANG	7
MF512R	6	ANG	7
MF513R	7	ANG	7
MF514R	8	ANG	7
MF515R	9	ANG	7
MF516R	10	ANG	7
MF517R	11	ANG	7
MF518R	12	ANG	7

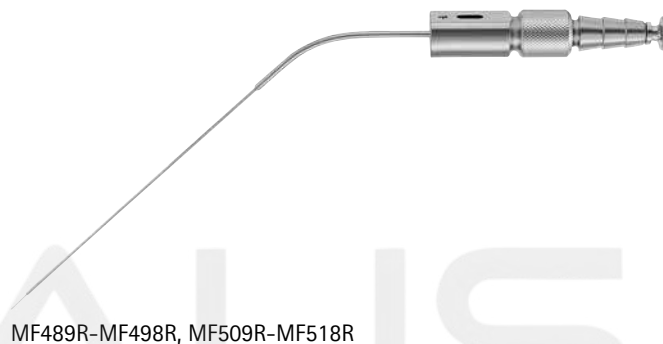
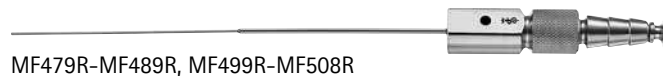

FRAZIER SUCTION TUBE W/ LUER HUB

Catalog Number	Tip Size (FR)	Length (in.)
GF923R	9	7
GF925R	15	7



FRAZIER LONG-SUCTION TUBE

Catalog Number	Tip Size (FR)	Length (in.)
MD091	3	6 1/2
MD092	5	6 1/2
MD093	6	6 1/2
MD094	7	6 1/2
MD095	8	6 1/2
MD096	9	6 1/2
MD097	10	6 1/2
MD098	11	6 1/2
MD099	12	6 1/2

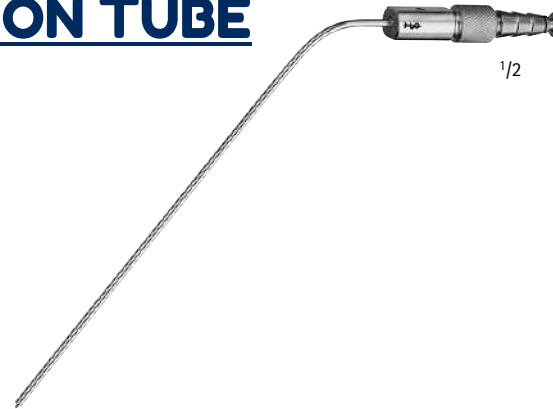

MD091-MD099

SUCTION TUBE, FUKUSHIMA STYLE, W/ TAPERED TEARDROP CONTROL

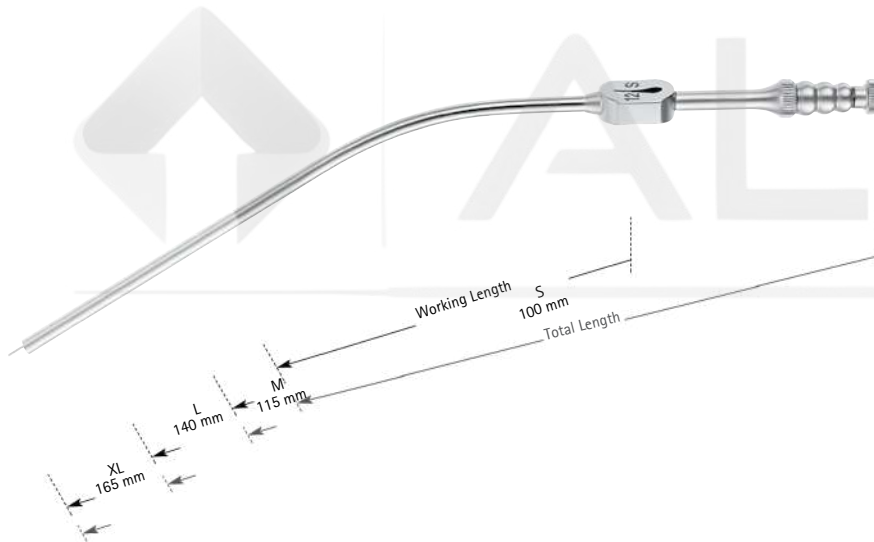

GF391R-GF429R

- Teardrop shaped thumb control for a very precise suction regulation
- Malleable material for individual forming of the suction hose
- Conical design of the tube prevents plugging
- Delivered with stylet

Catalog Number	Size	Tip Size (mm)	Tip Size (FR)	Working Length (in.)	Length (in.)
GF401R	S	1.0	3	4	6 1/2
GF402R	S	1.4	4	4	6 1/2
GF403R	S	1.7	5	4	6 1/2
GF404R	S	2.0	6	4	6 1/2
GF405R	S	2.3	7	4	6 1/2
GF406R	S	2.7	8	4	6 1/2
GF407R	S	3.0	9	4	6 1/2
GF408R	S	3.3	10	4	6 1/2
GF409R	S	4.0	12	4	6 1/2
GF391R	M	1.0	3	4 1/2	7
GF392R	M	1.4	4	4 1/2	7
GF393R	M	1.7	5	4 1/2	7
GF394R	M	2.0	6	4 1/2	7
GF395R	M	2.3	7	4 1/2	7
GF396R	M	2.7	8	4 1/2	7
GF397R	M	3.0	9	4 1/2	7
GF398R	M	3.3	10	4 1/2	7
GF399R	M	4.0	12	4 1/2	7
GF411R	L	1.0	3	5 1/2	8
GF412R	L	1.4	4	5 1/2	8
GF413R	L	1.7	5	5 1/2	8
GF414R	L	2.0	6	5 1/2	8
GF415R	L	2.3	7	5 1/2	8
GF416R	L	2.7	8	5 1/2	8
GF417R	L	3.0	9	5 1/2	8
GF418R	L	3.3	10	5 1/2	8
GF419R	L	4.0	12	5 1/2	8
GF421R	XL	1.0	3	6 1/2	9
GF422R	XL	1.4	4	6 1/2	9
GF423R	XL	1.7	5	6 1/2	9
GF424R	XL	2.0	6	6 1/2	9
GF425R	XL	2.3	7	6 1/2	9
GF426R	XL	2.7	8	6 1/2	9
GF427R	XL	3.0	9	6 1/2	9
GF428R	XL	3.3	12	6 1/2	9
GF429R	XL	4.0	12	6 1/2	9

GENERAL SURGERY

Suction Tubes

LANDOLT DISSECTING SUCTION TUBE

Catalog Number	Tip	Tip Size (mm)	Length (in.)
GF980R	ANG, SHARP	3.2	7 7/8



SACHS SUCTION TUBE

Catalog Number	Tip Size	Length (in.)
MB635R	SMALL	8 1/2
MB636R	LARGE	8 1/2



PRIBRAM SUCTION TUBE WITH THUMB CONTROL

Catalog Number	Tip	Length (in.)
US106	16	5 1/2
US107	18	5 1/2



OCHSNER TROCAR

Catalog Number	Tip Size (FR)	Length (in.)
MG100R	10	6
MG101R	12	6
MG102R	14	6
MG103R	16	6
MG104R	18	6
MG105R	20	6
MG106R	22	6
MG107R	24	6
MG108R	26	6
MG109R	27	6
MG110R	28	6



GENERAL SURGERY

Rulers and Calipers

STEEL RULER, GRADUATED IN MILLIMETERS AND INCHES

Catalog Number	Length (in.)
AA804R	6
AA805R	11 3/4
AA806R	19 3/4



AA804R-AA806R

RULER, F/ X-RAY WORK

Catalog Number	Length (in.)
AA808R	19 3/4

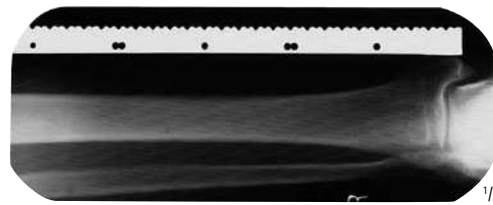

AA808R



FINGER-GONIOMETER

Catalog Number
AD110R

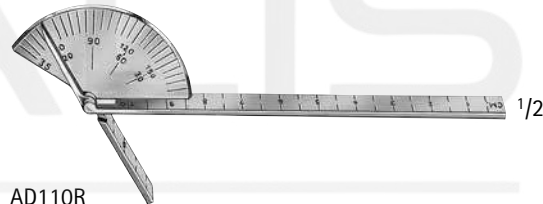

AD110R

GENERAL SURGERY

Accessories

SURGICAL SPOON

Catalog Number	Size	Blade Size (mm)	Length (in.)
MG003R	SMALL	25	4 1/4
MG002R	MEDIUM	30	5 1/4
MG004R	MEDIUM-LARGE	35	6 1/4
MG001R	LARGE	40	7 1/2



MG001R-MG004R

GENERAL SURGERY

Accessories

STAPLE REMOVER

Catalog Number	Description
783102	REUSABLE
783101	SINGLE USE (BOX OF 6)



TAYLOR PERCUSSION HAMMER

Catalog Number	Size	Length (in.)
MG377R	SMALL	7
MG378R	LARGE	7 3/4



GENERAL SURGERY

Metal Bowls and Cups

METAL SPONGE BOWL

Catalog Number	Capacity (qts.)
US061	1
US060	1 1/2
US062	1 7/8



METAL CUP

Catalog Number	Item	Capacity (oz.)
US066	MEDICINE CUP	2
US063	IODINE CUP	6
US067	SOLUTION BASIN	12
US065	IODINE CUP	14
US064	GRADUATED MEASURE	32



KIDNEY TRAY

Catalog Number	Length (in.)
JG504R	6 3/4
JG506R	9 3/4

